

尺寸：28cmX28cm



Installation

Step 1 →

- Remove your screen door and lay it down on a flat or any other hard surface.
- Separate the frames of the pet door.
- Place them on opposite sides of the screen, preferably in a lower corner.

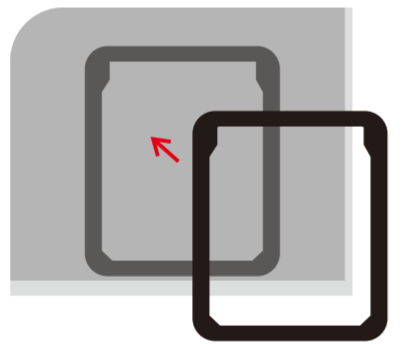

Step 2 →

- Align pins and hold tightly into the frames.
- Snap them by tapping or with a hammer whichever would make it totally together.
- Tighten the screws.

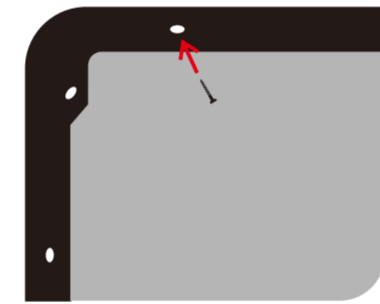

Step 3 →

Using a knife, cut off the screen follow the dog door.

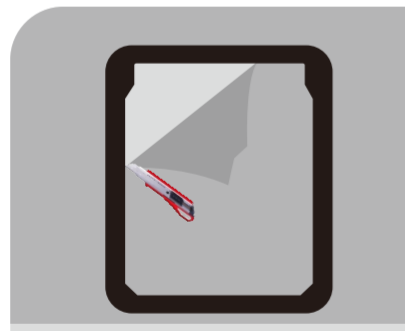

Step 4 →

Bend the inner door, and put in. Finishing!

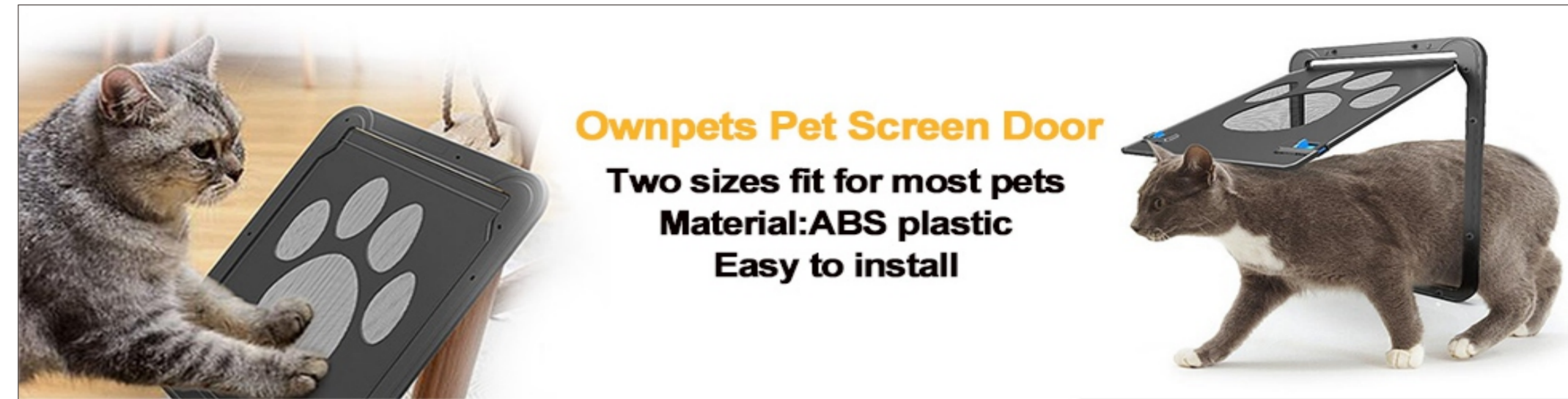
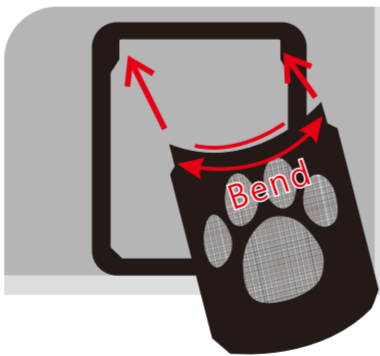

Please measuring your pet before install

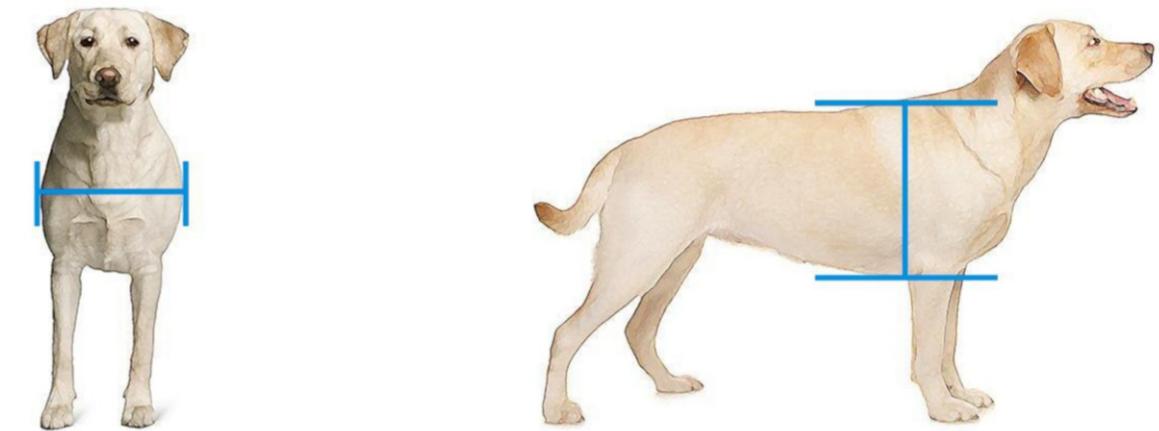

PET0075

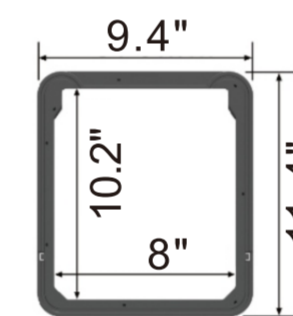

PET0041

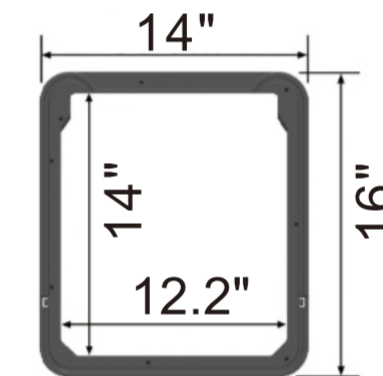

Dear Customers,
Do you like your purchase? Or do you find this product make it convenient for your pets? If so, would you mind leave a product review in the shopping site like Amazon? In doing so, you'll share your using experience with millions of fellow customers who are waiting your feedback.

If you are not satisfied, please contact our customer service email : brainydeal@gmail.com. We are looking forward to your suggestions.

Ownpets~

正面

背面