

A

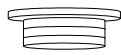

B

A



x 1

B



x 1

C

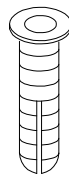

x 1

D

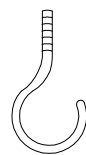

x 1

1

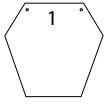

x 1

2

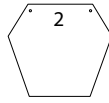

x 1

3

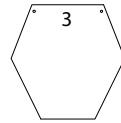

x 1

4

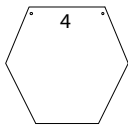

x 1

5

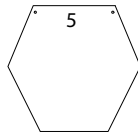

x 1

6

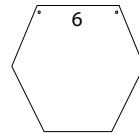

x 1

7

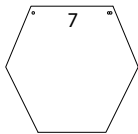

x 1

8

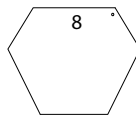

x 1

9

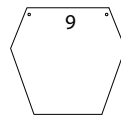

x 1

10

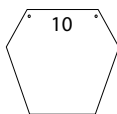

x 1

11

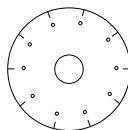

x 1

12

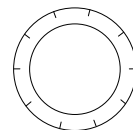

x 1

13



x 1



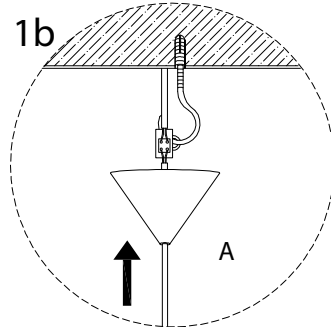
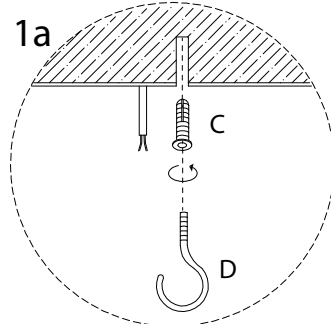
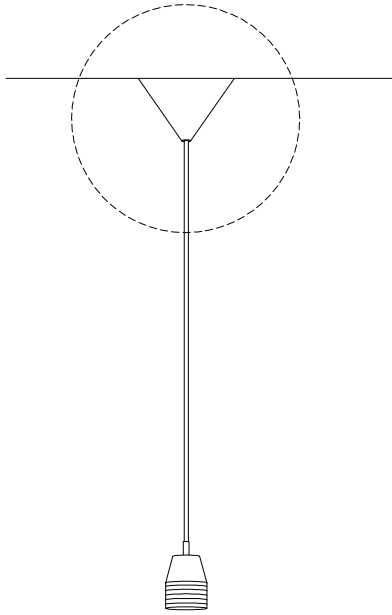
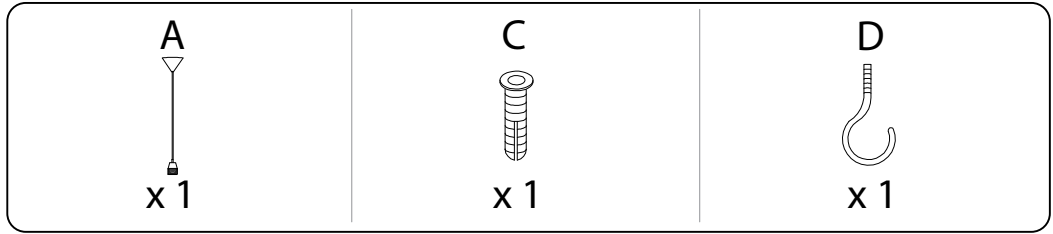

1

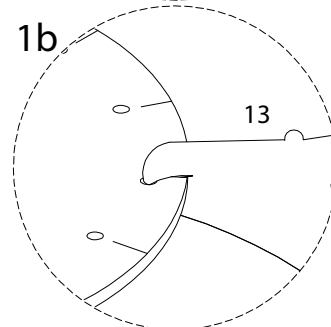
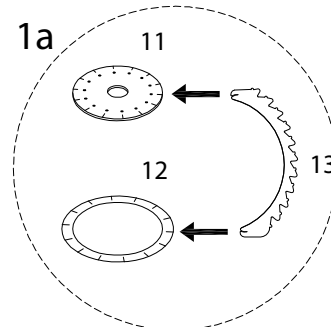
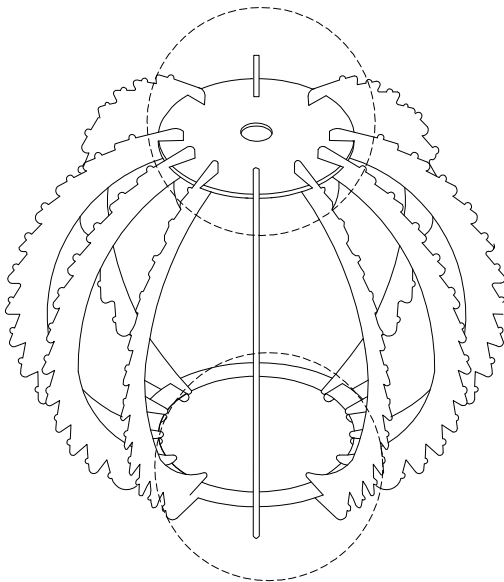
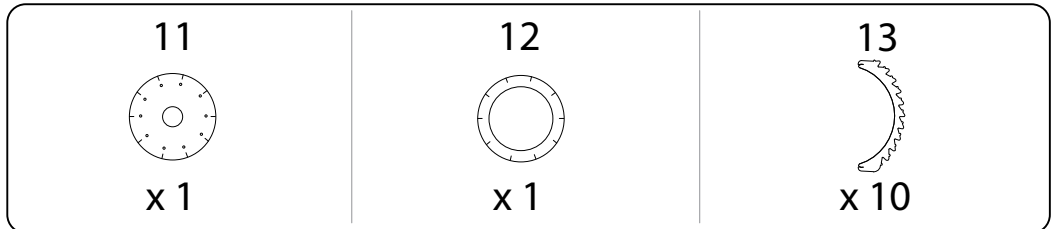

2

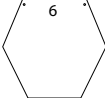
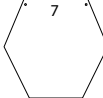
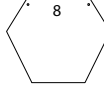
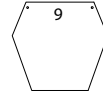
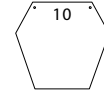

3

1  x 5	2  x 5	3  x 5	4  x 5	5  x 5
6  x 5	7  x 5	8  x 5	9  x 5	10  x 5

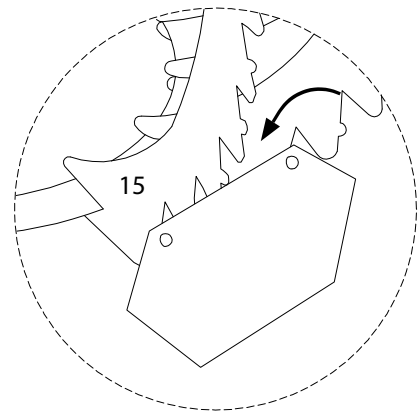
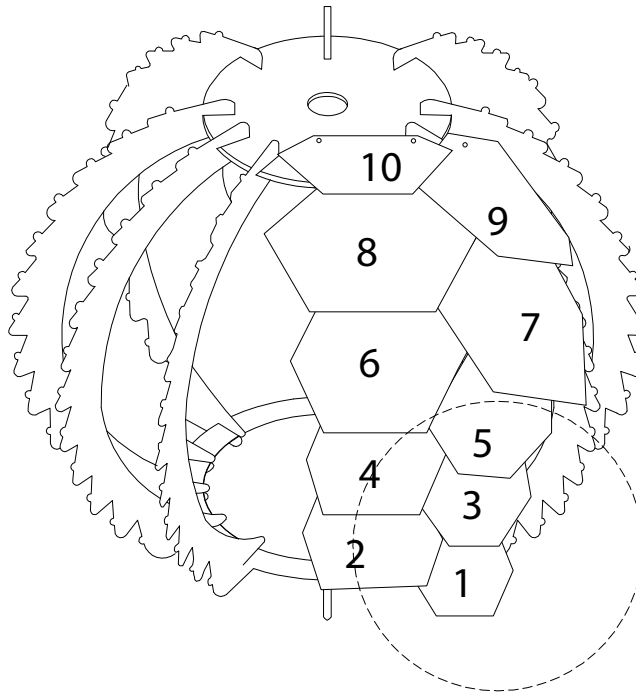

4

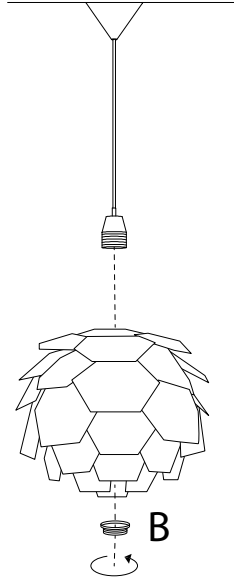
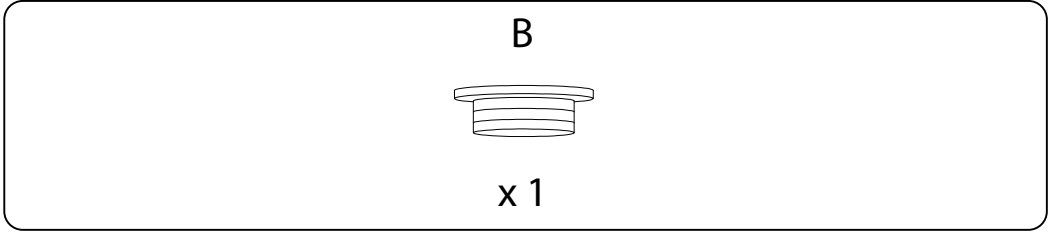

5

