

400mm/15.74in

2000mm/78.74in

611mm/24.05in

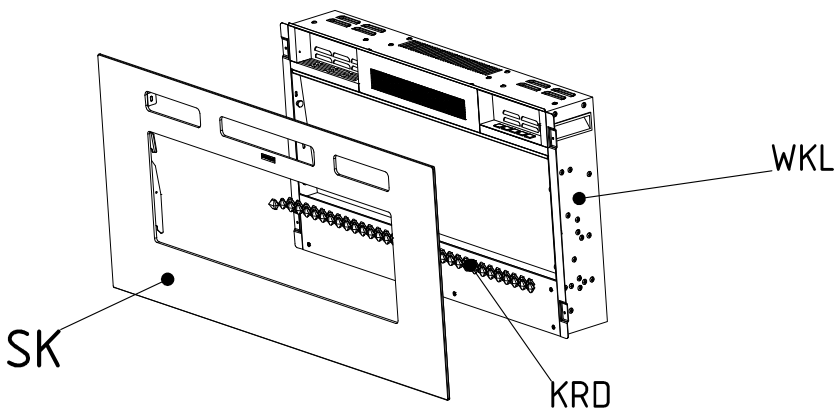
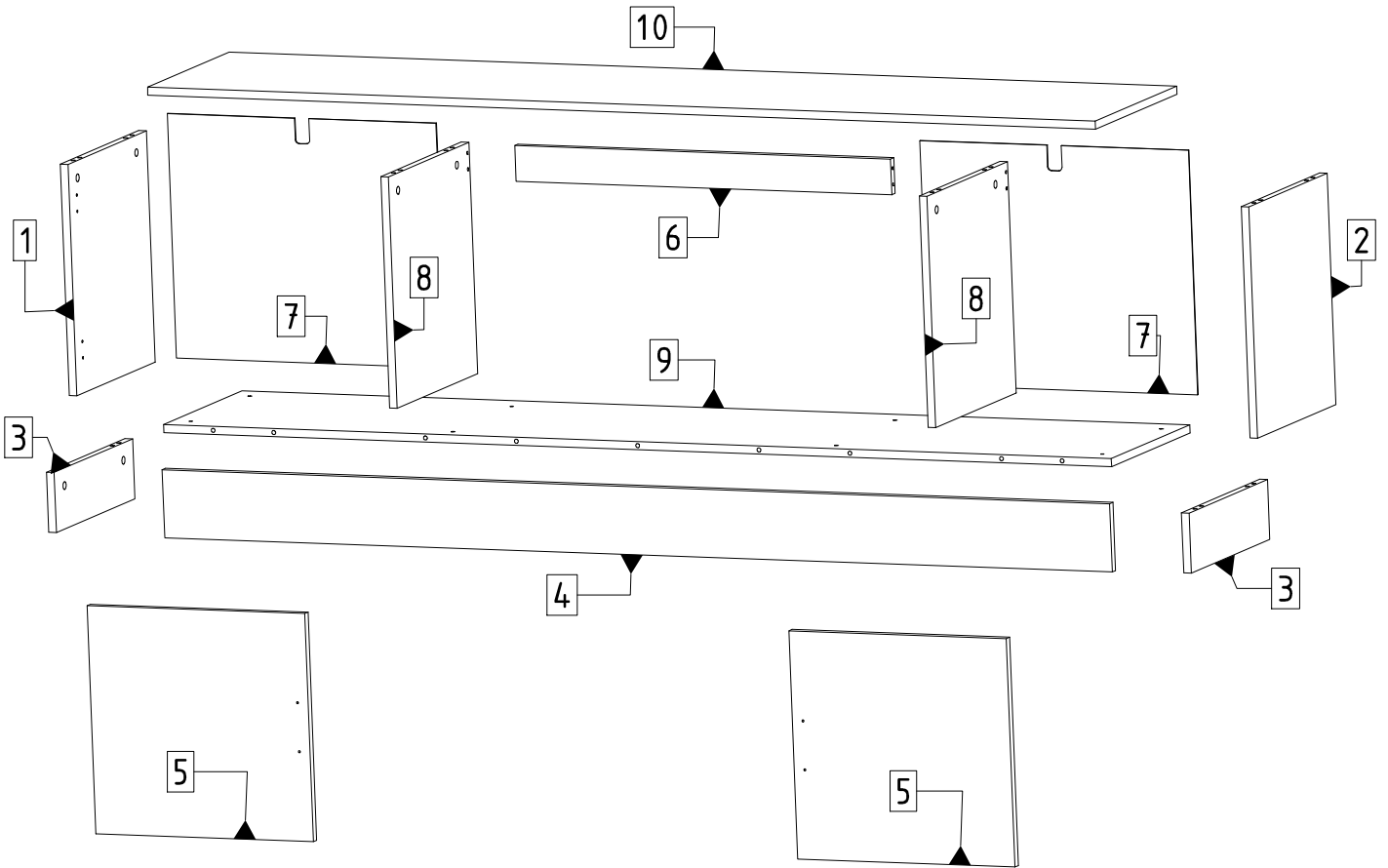
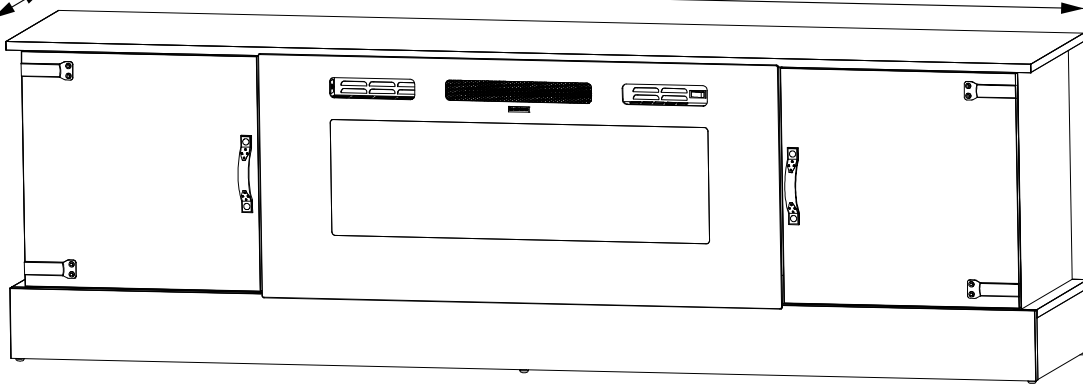
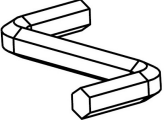
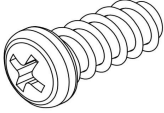
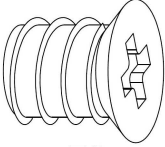
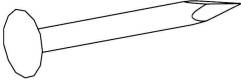
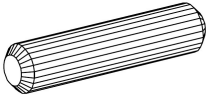
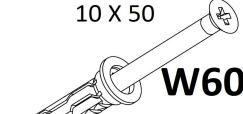

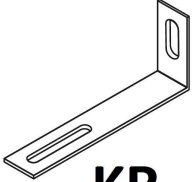

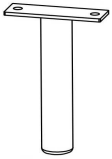
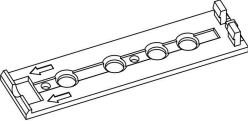
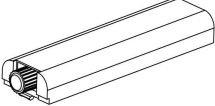
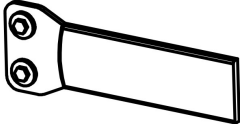
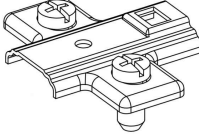
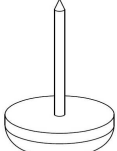
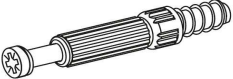

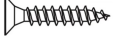

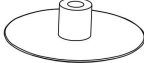

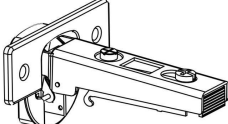
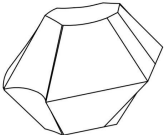
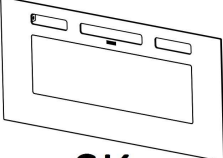
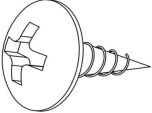
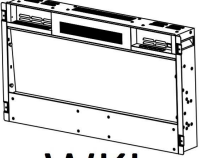
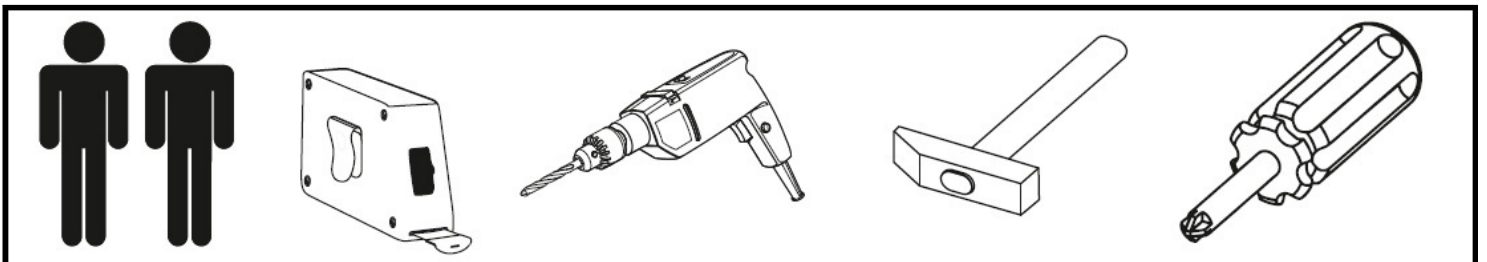
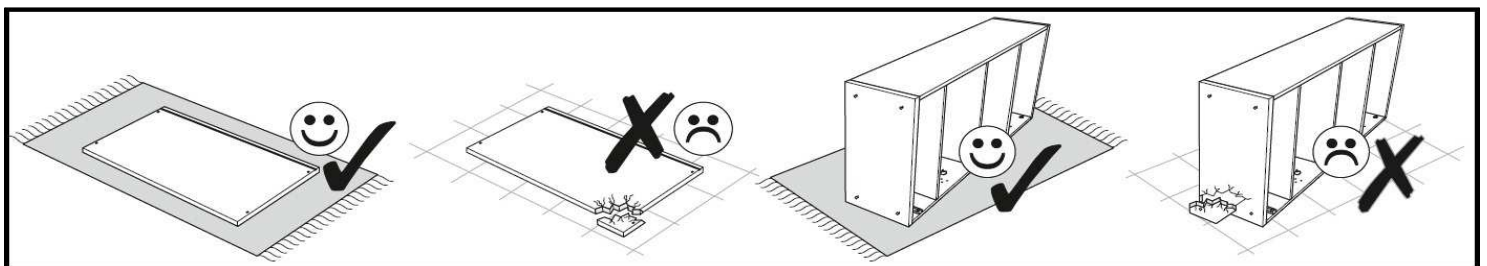

Table accessories

 A1	6,3 X 13  E13	6,3x9mm  E3	 G	8 x 30  K
10 X 50  K1	 KN	 KR	15 x 12  M	H=124mm  N124
 OB	 OB2	 ORET	 PE	 SL
6 x 34 mm  T	 URET	4 x 16  W16	4 X 25mm  W4	 Z
 ZK	 ZPH			
 KRD	 SK	 WK	 WKL	



Elements				Accessories	
SYMBOL	LENGTH	WIDTH	QUANTITY	SYMBOL	QUANTITY
BL [1]	17.91	15.12	1	A1	1
BP [2]	17.91	15.12	1	E13	2
CB [3]	15.12	4.65	2	E3	4
CD [4]	78.74	5.28	1	G	36
FT [5]	18.07	17.68	2	K	16
LT [6]	31.22	2.76	1	K1	2
PC [7]	22.32	18.94	2	KN	12
PPIO [8]	17.91	15.51	2	KR	2
WD [9]	78.74	15.12	1	KRD	32
WG [10]	78.74	15.75	1	M	17
				N124	1
				OB	2
				OB2	2
				ORET	4
				PE	4
				SK	1
				SL	5
				T	17
				URET	2
				W16	12
				W4	8
				W60	2
				WK	6
				WKL	1
				Z	17
				ZK	4
				ZPH	4



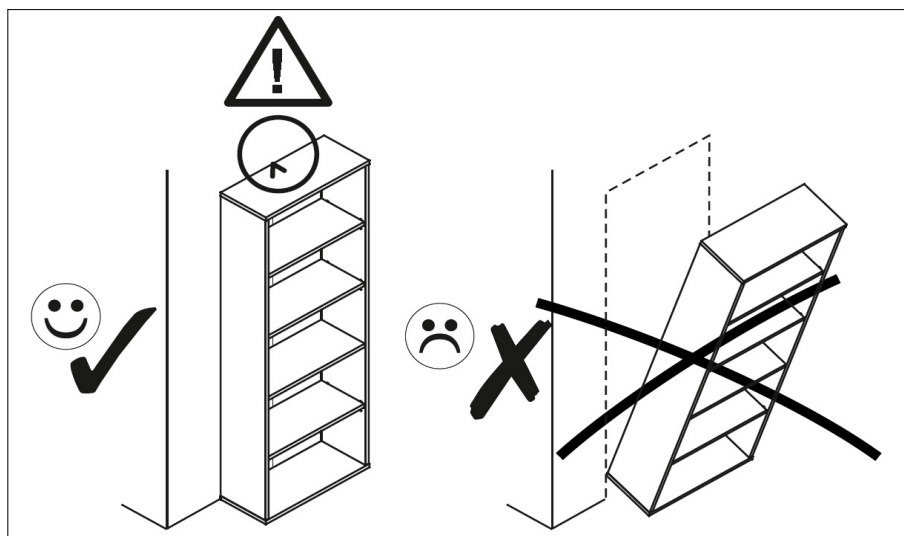

PL
UWAGA! Mebel trzeba trwale zamocować do ściany, aby uniknąć przewrócenia się mebla. W paczce są akcesoria przystosowane wyłącznie do ścian betonowych i z pełnej cegły. Jeśli nie jesteś pewien co do budowy ściany, skonsultuj się ze specjalistą.

EN
ATTENTION! The furniture must be permanently attach to the wall, to avoid falling over furniture. There are accessories in the package adapted only to the walls concrete and solid brick. If you are not sure about the construction walls, consult expert.

IT
NOTA! I mobili devono essere permanenti attaccare al muro, per evitare di cadere mobili. Ci sono accessori nel pacchetto adattato solo alle pareti mattone concreto e solido. se non sei sicuro della costruzione muri, consultare specialista.

D
ACHTUNG! Die Möbel müssen dauerhaft sein an der Wand befestigen, um nicht umzufallen Möbel. Es gibt Zubehör in der Verpackung nur an die Wände angepasst Beton und Vollziegel. wenn Sie sind sich nicht sicher über die Konstruktion Wände konsultieren Spezialist.

ES
NOTA! La pieza necesita ser permanentemente pegar a la pared, para evitar caerse muebles. Están en el paquete accesorios adaptados solo para paredes Hormigón y ladrillo macizo. si no estás seguro de la construcción Paredes, consultar a un especialista.

FR
REMARQUE! La pièce doit être en permanence attacher au mur, pour éviter de tomber meubles. Ils sont dans le paquet accessoires adaptés seulement pour les murs béton et brique pleine. si vous n'êtes pas sûr de la construction murs, consultez un spécialiste.

CZ
POZOR! Kus musí být natrvalo připevnit ke zdi, aby se zabránilo pádu nábytku. Jsou v balení příslušenství přizpůsobené pouze pro stěny betonové a pevné cihly. pokud Nejste si jisti stavbou konzultovat odborníka.

SLO
POZOR! Kus musí byť natrvalo pripojit' k stene, aby sa zabránilo pádu nábytku. Sú v balení príslušenstvo prispôsobené len pre steny betón a pevné tehly. ak Nie ste si istý stavbou konzultujte s odborníkom.

1.

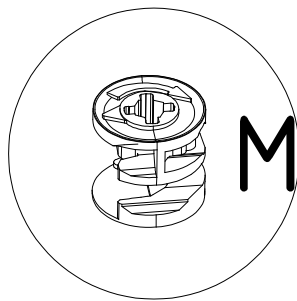
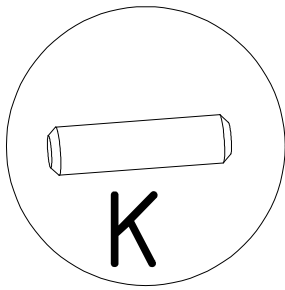

1.

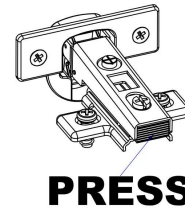

2.

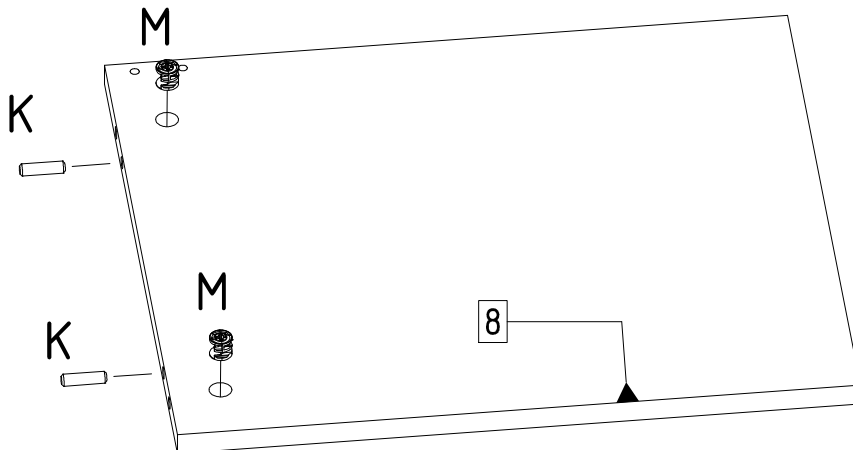
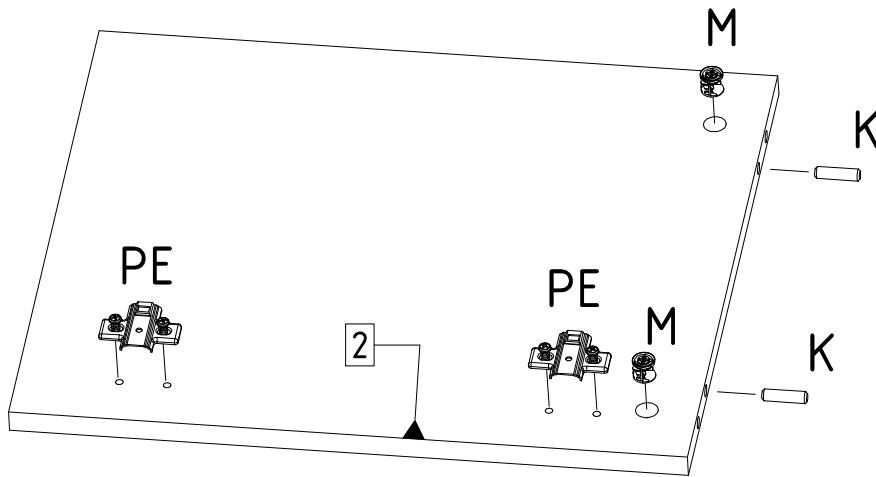
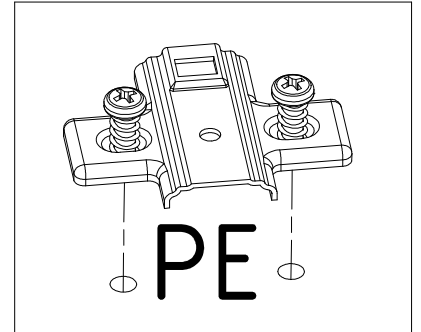
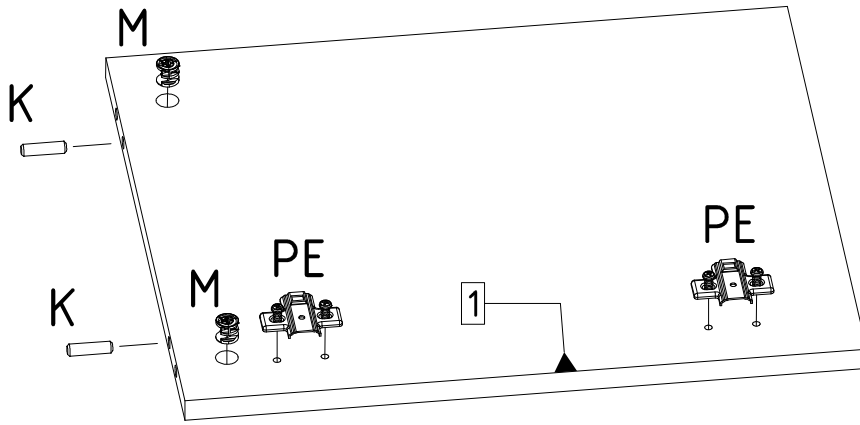
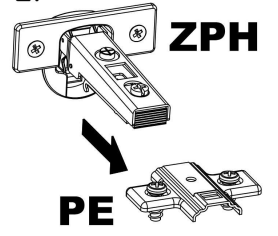

x2

2.

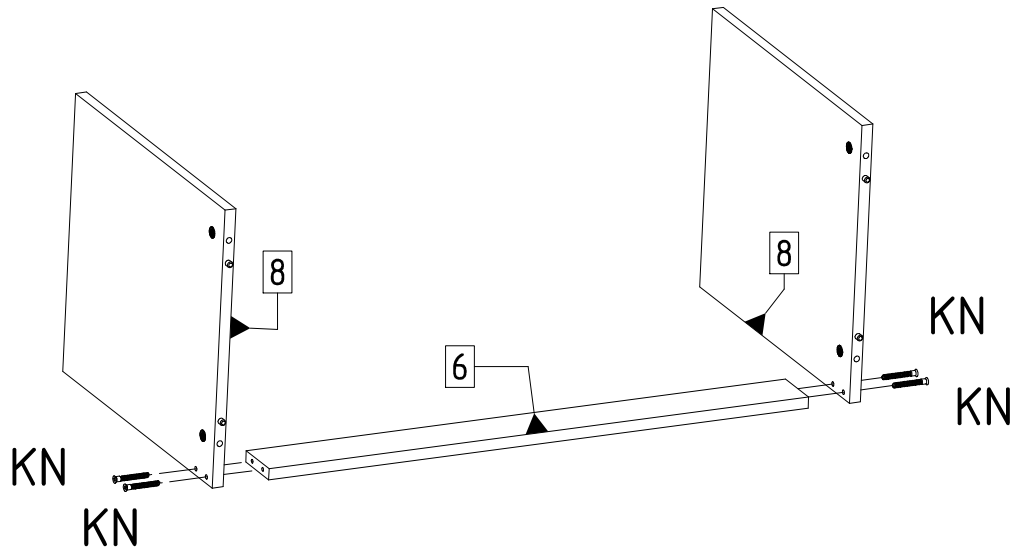

3.

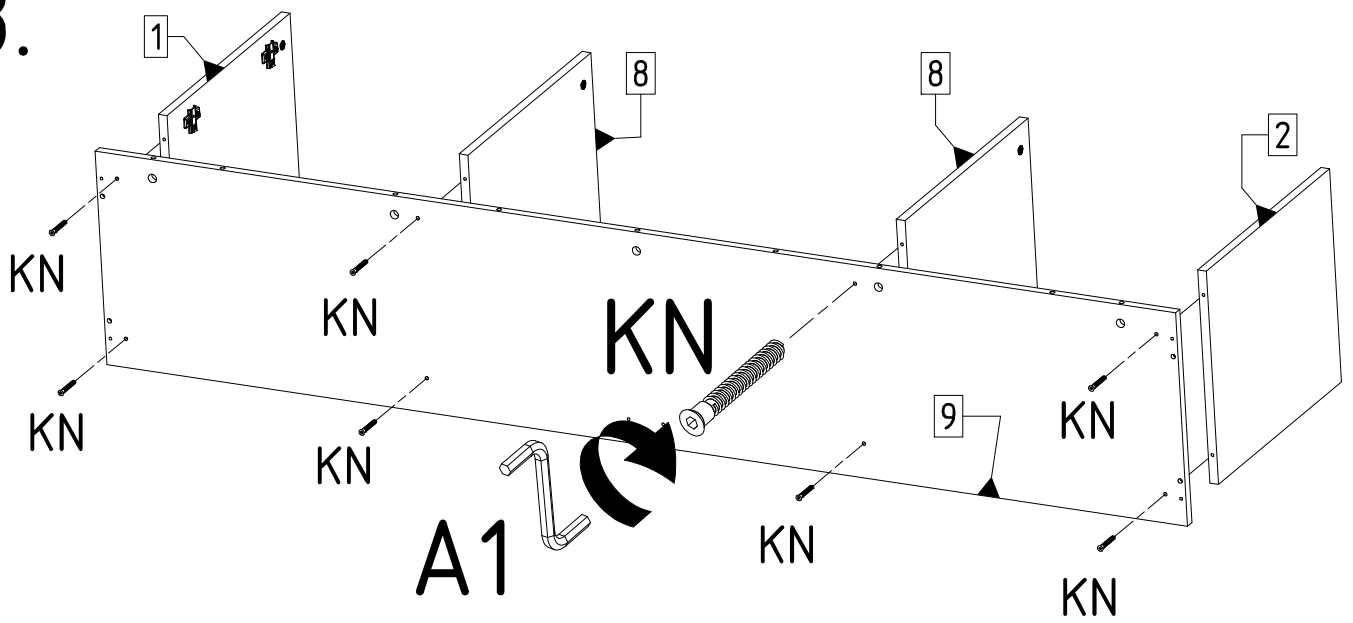

4.

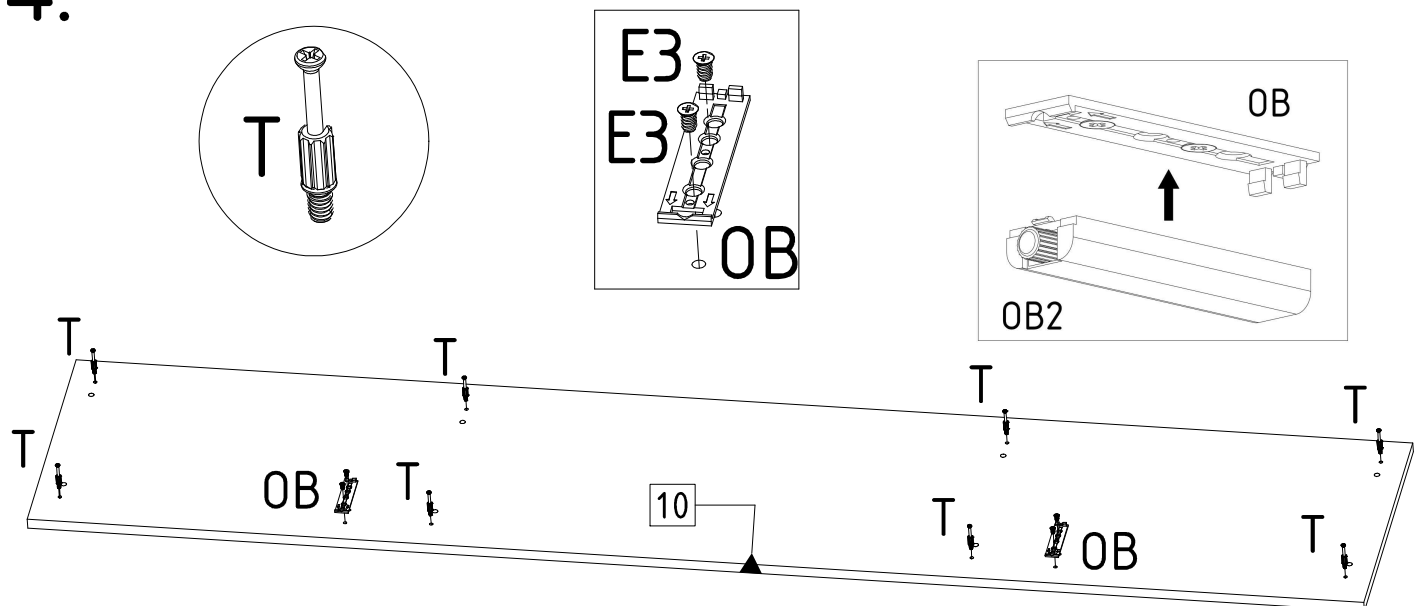

5.

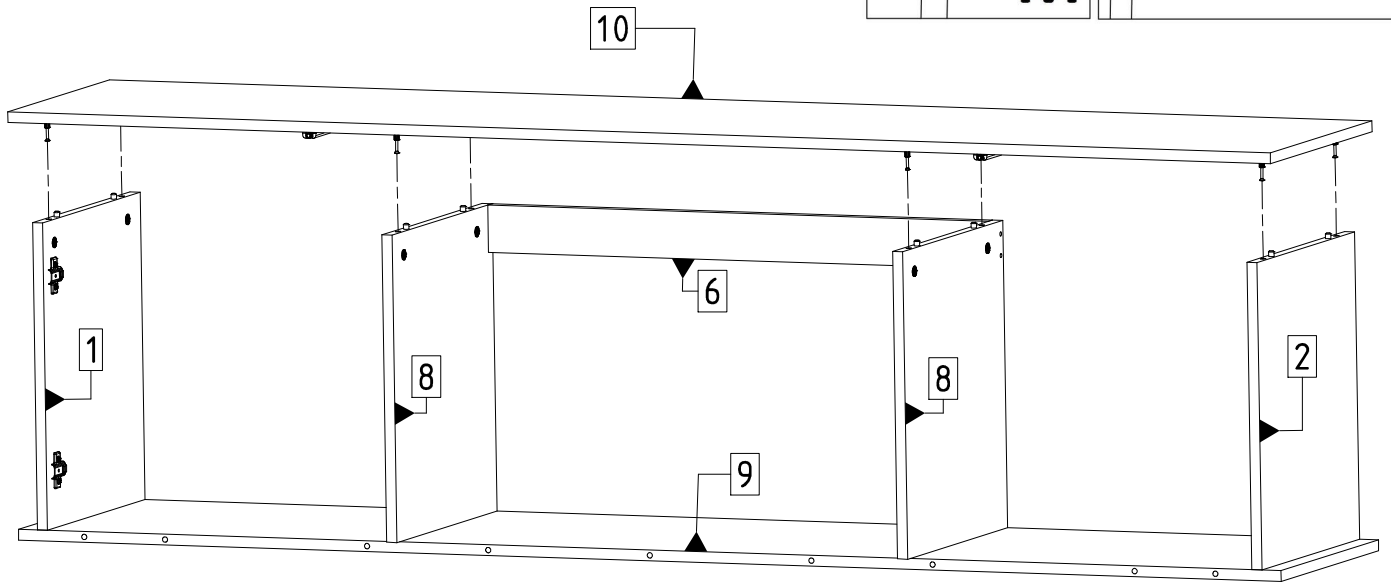
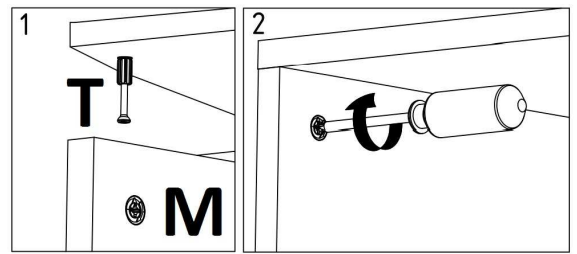

6.

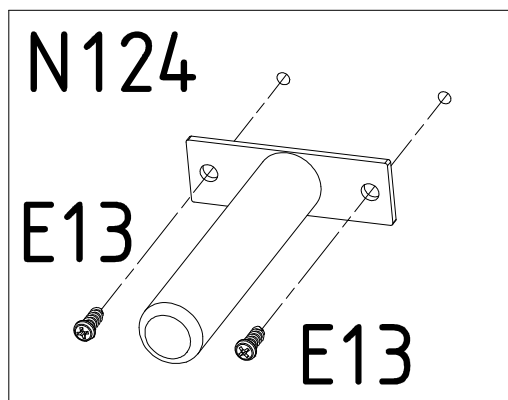
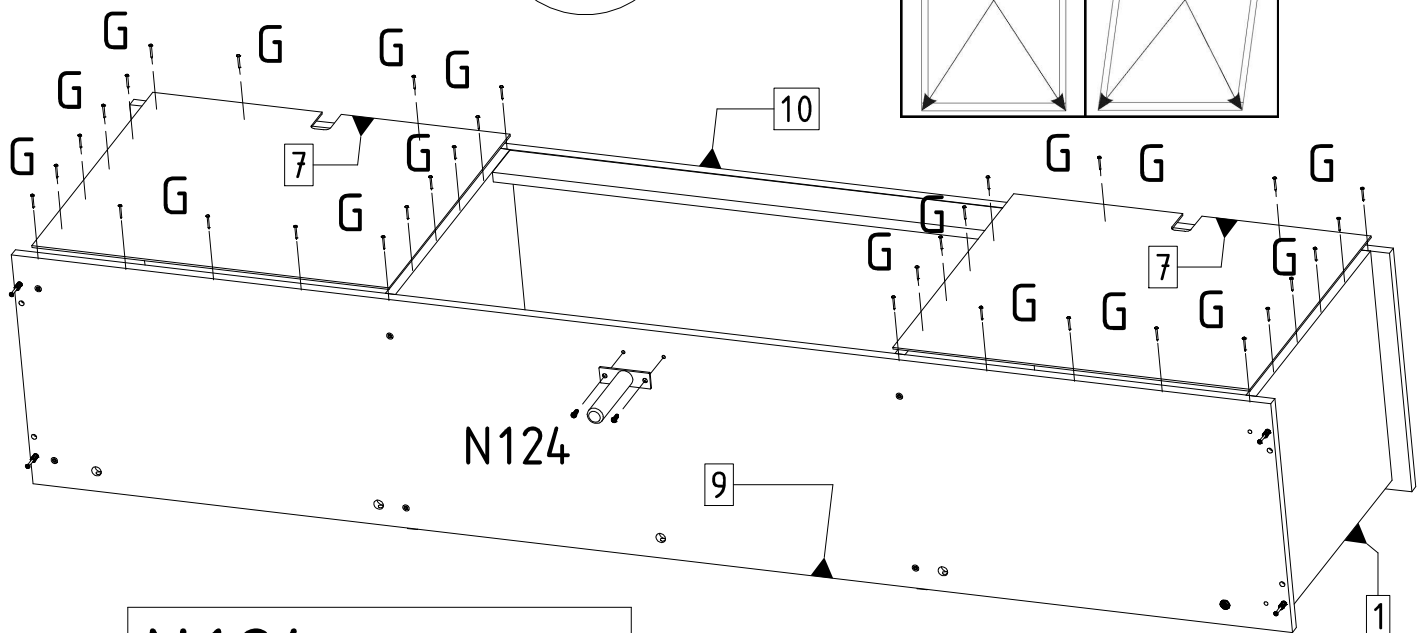
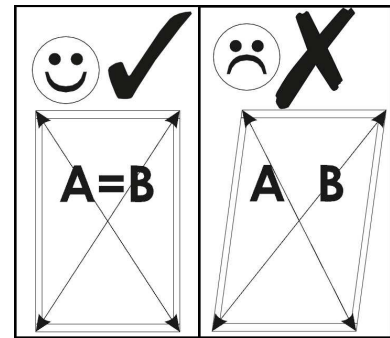
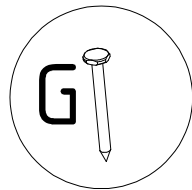

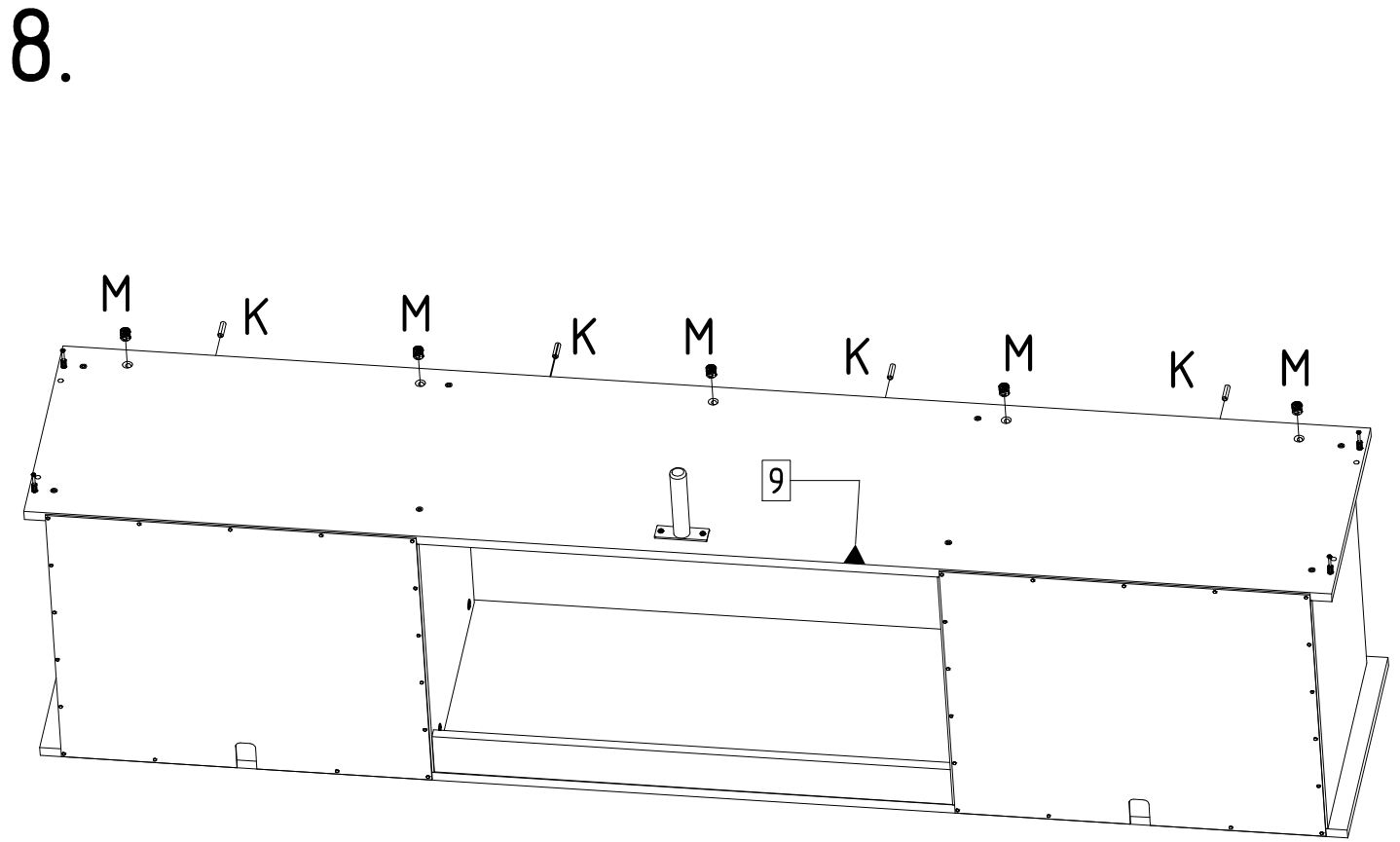
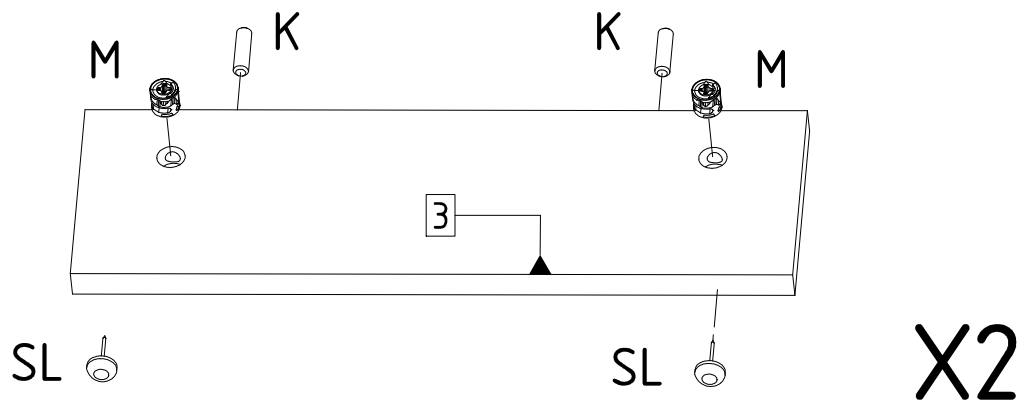
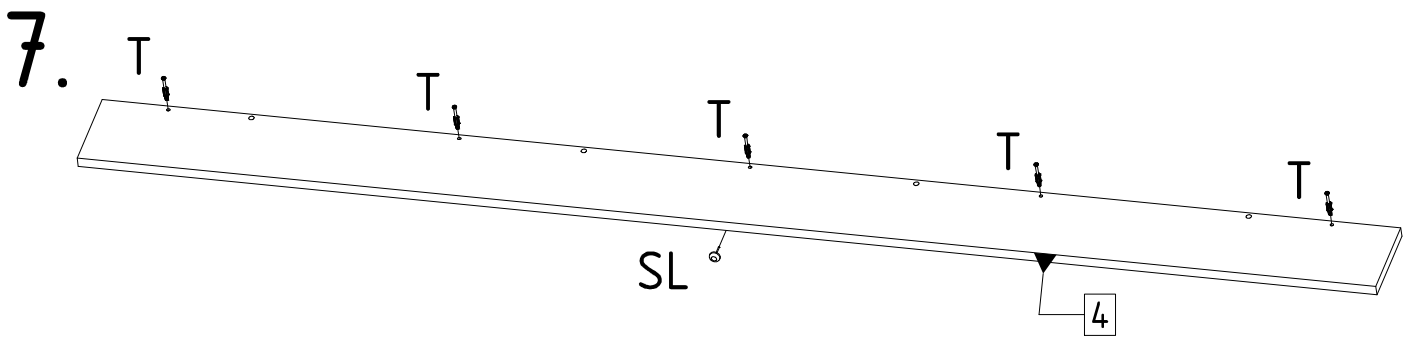

9.

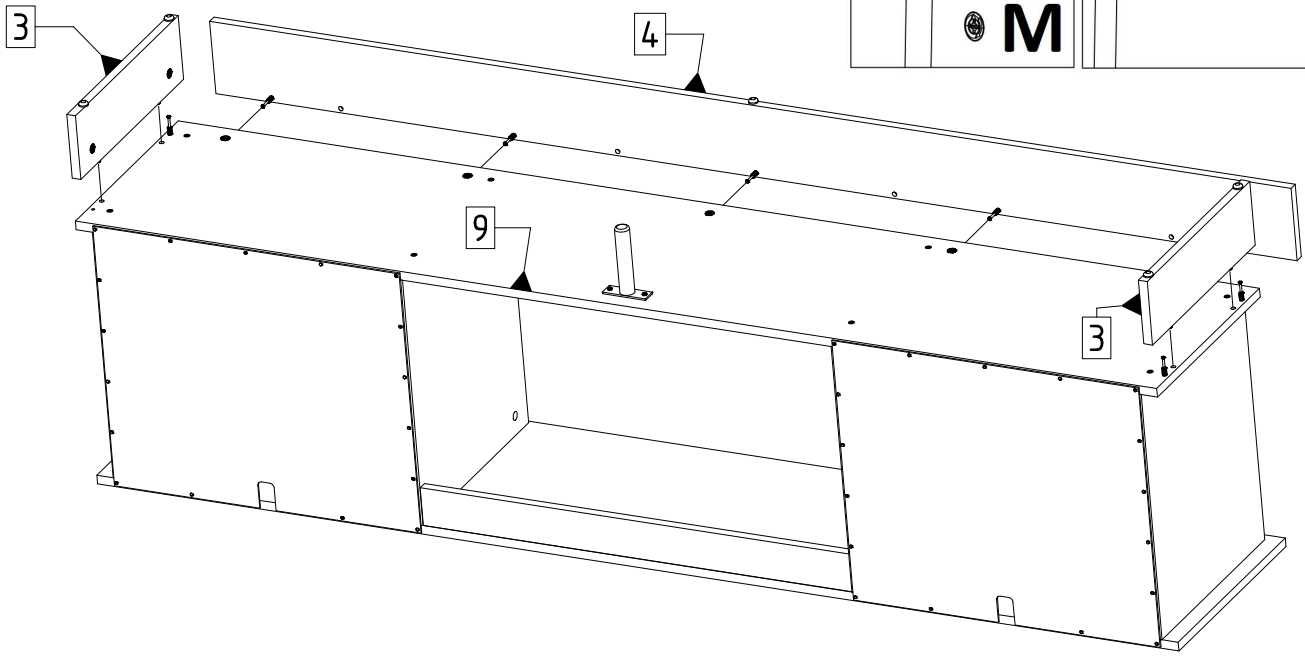

10.

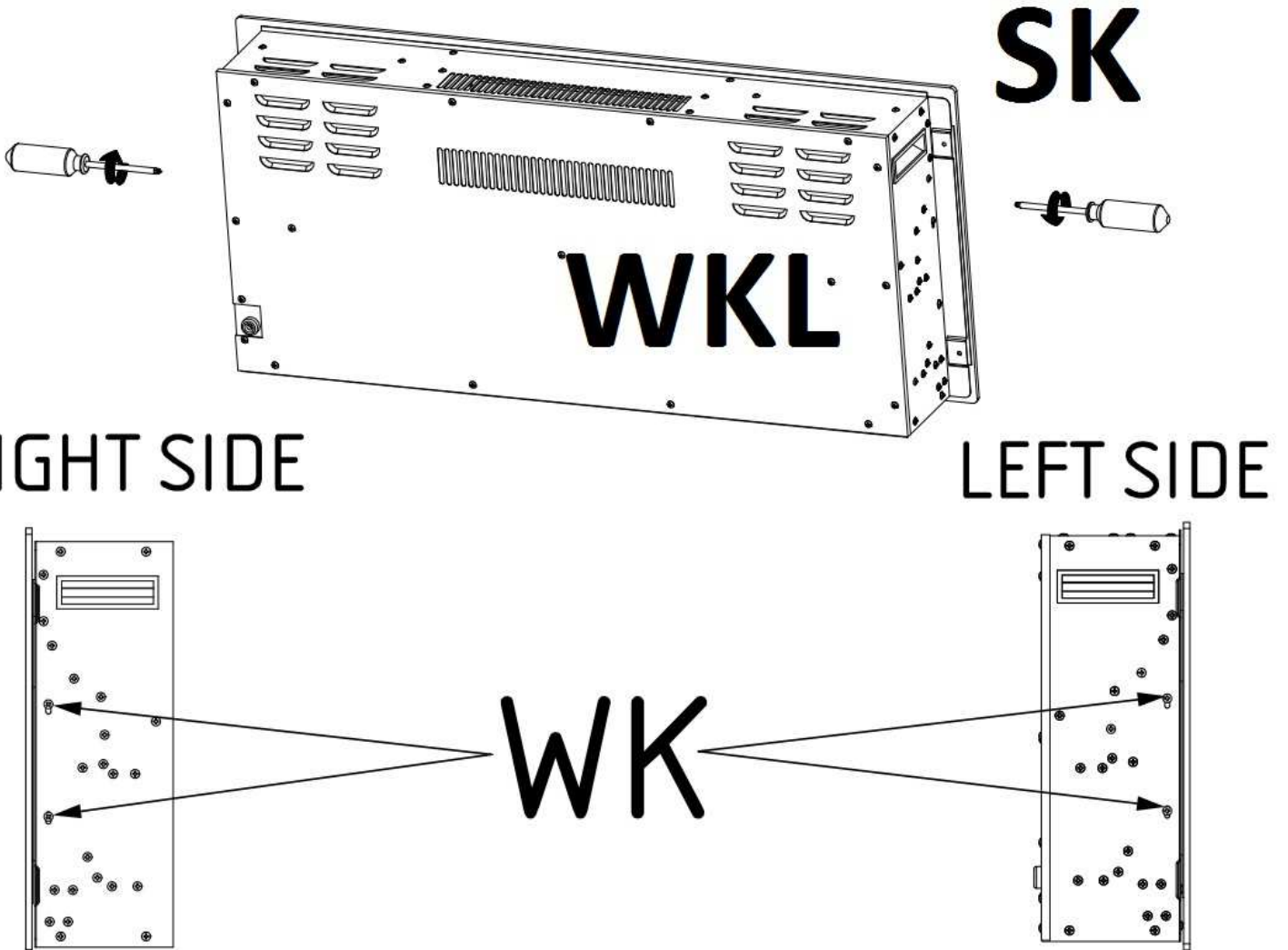

11.

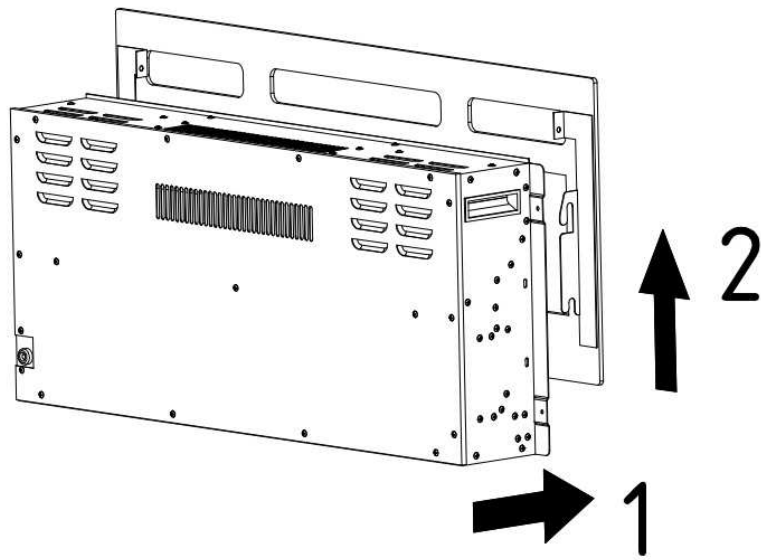

12.

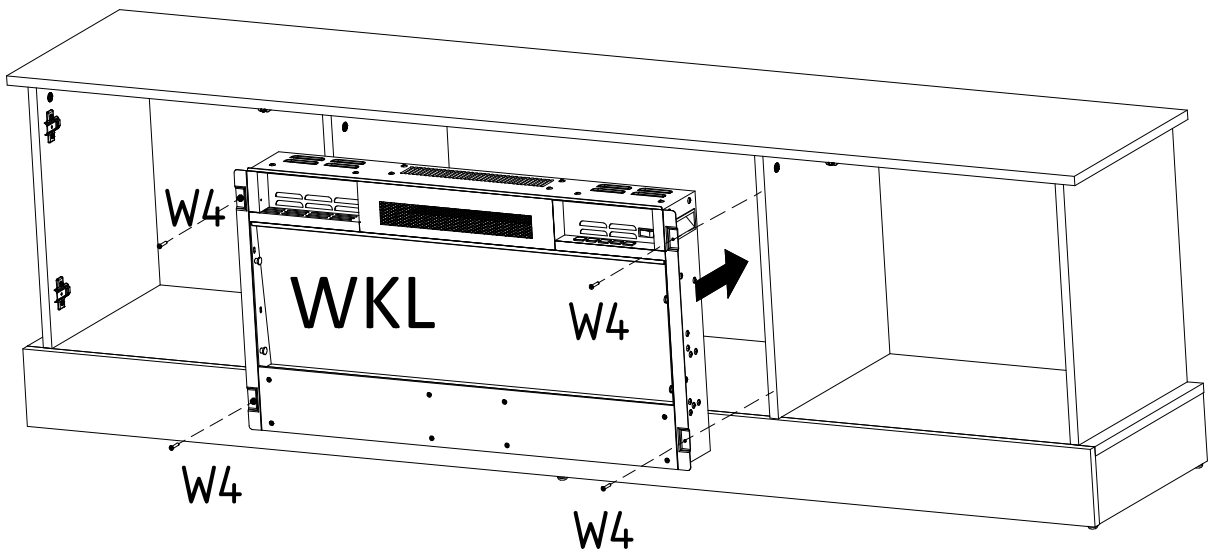
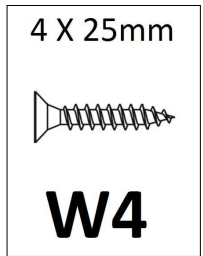

13.

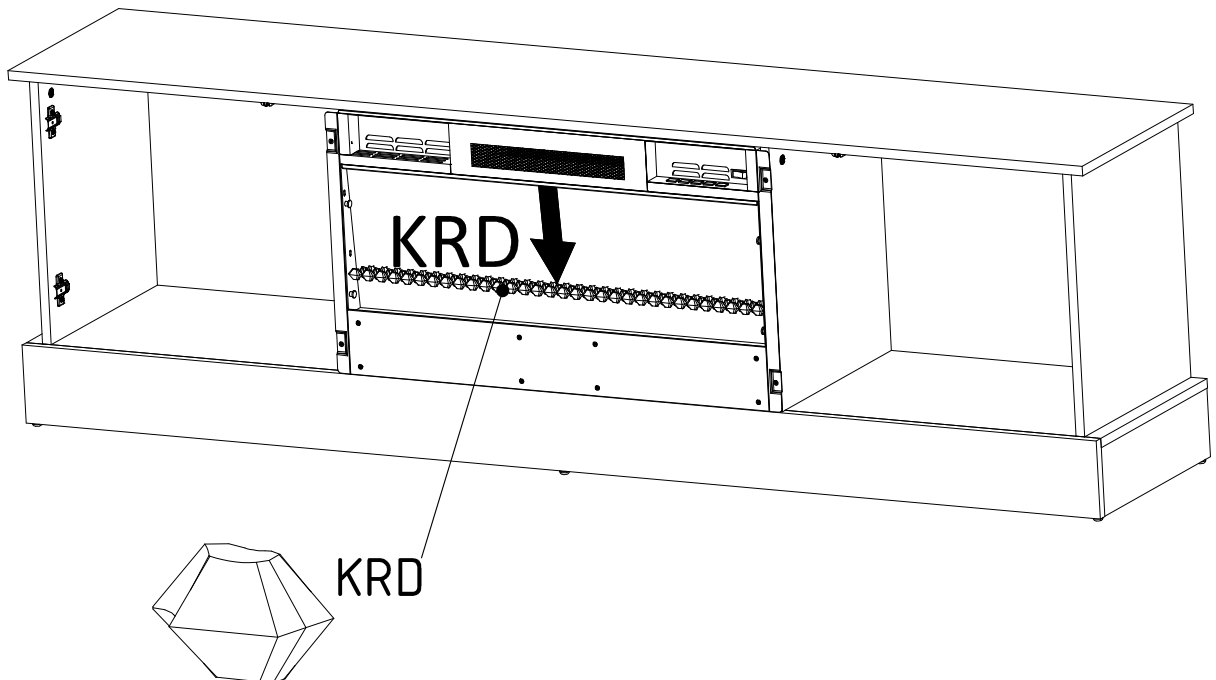

14.

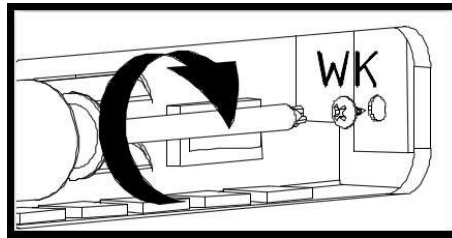
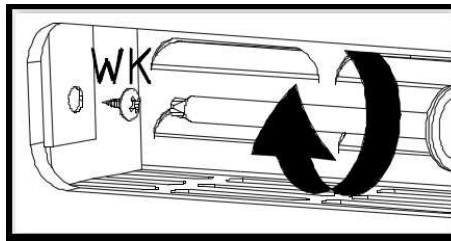
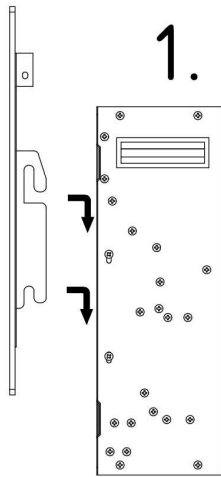
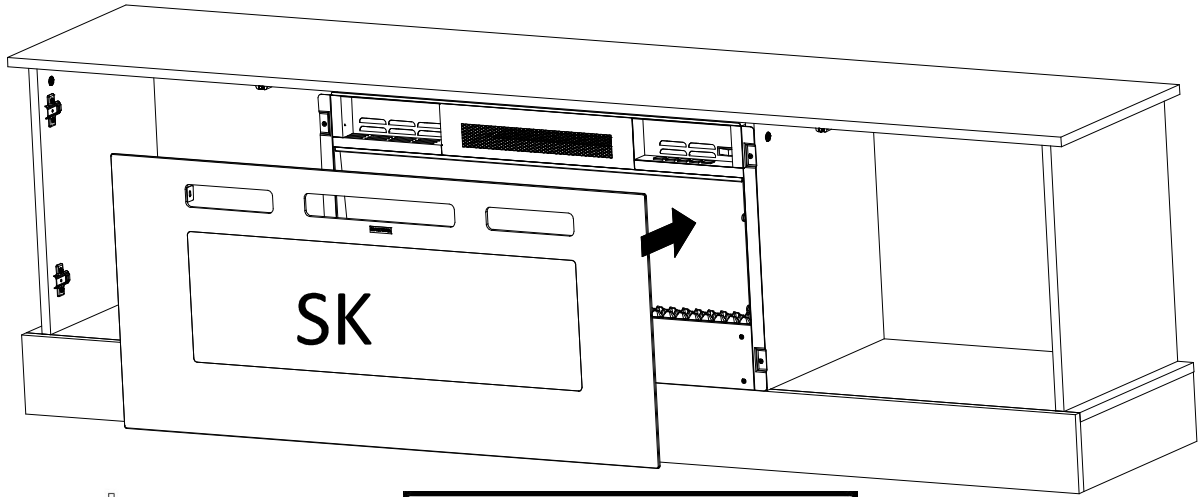

15.

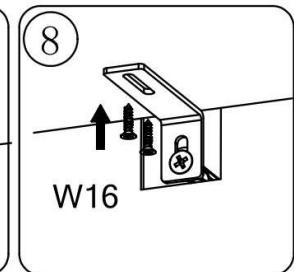
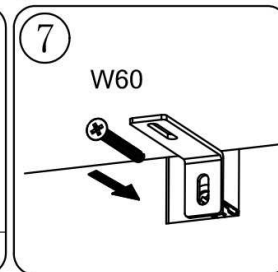
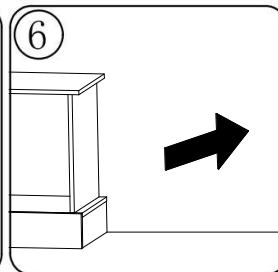
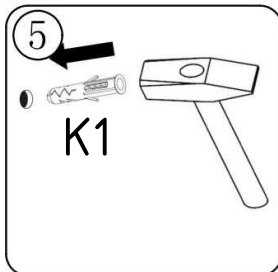
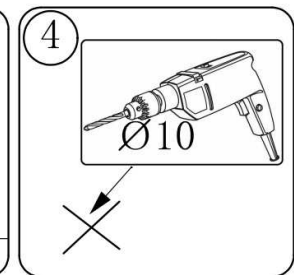
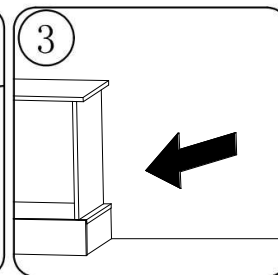
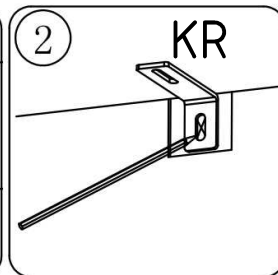
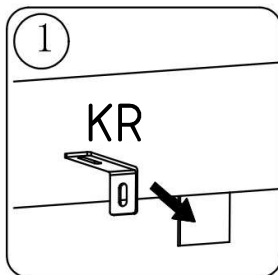
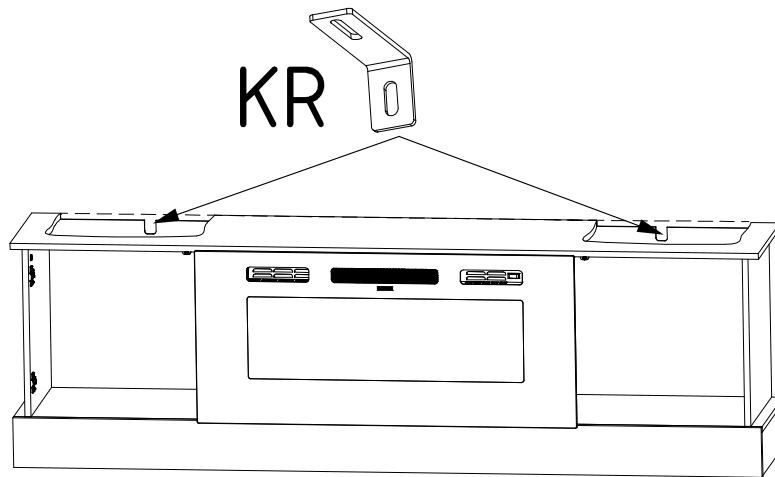

16.

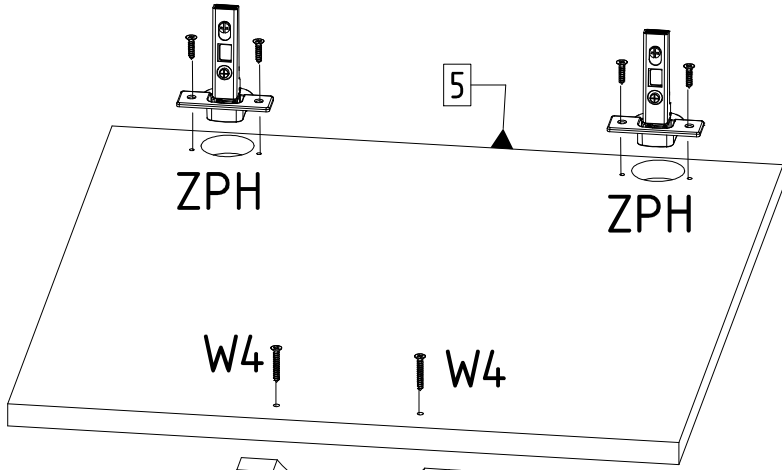

URET

x2

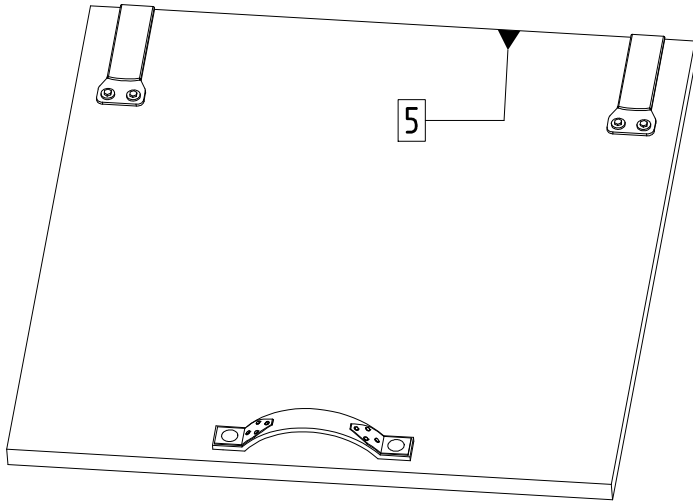
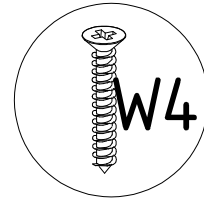
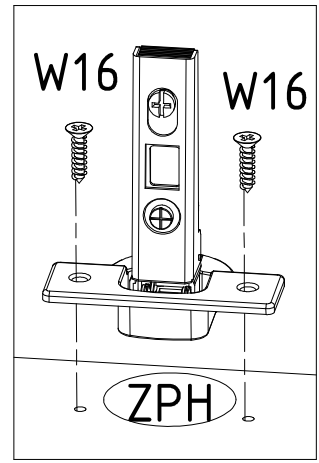

x2

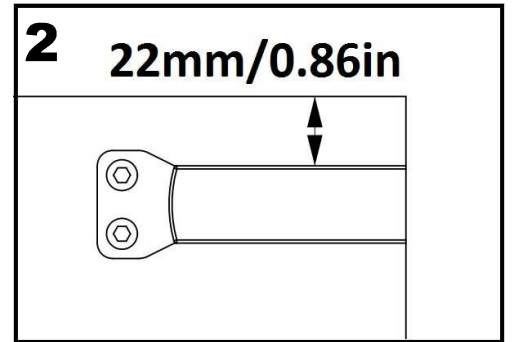
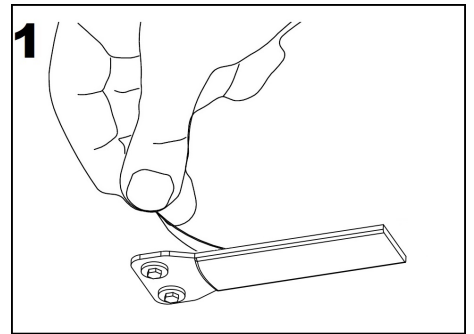

17.

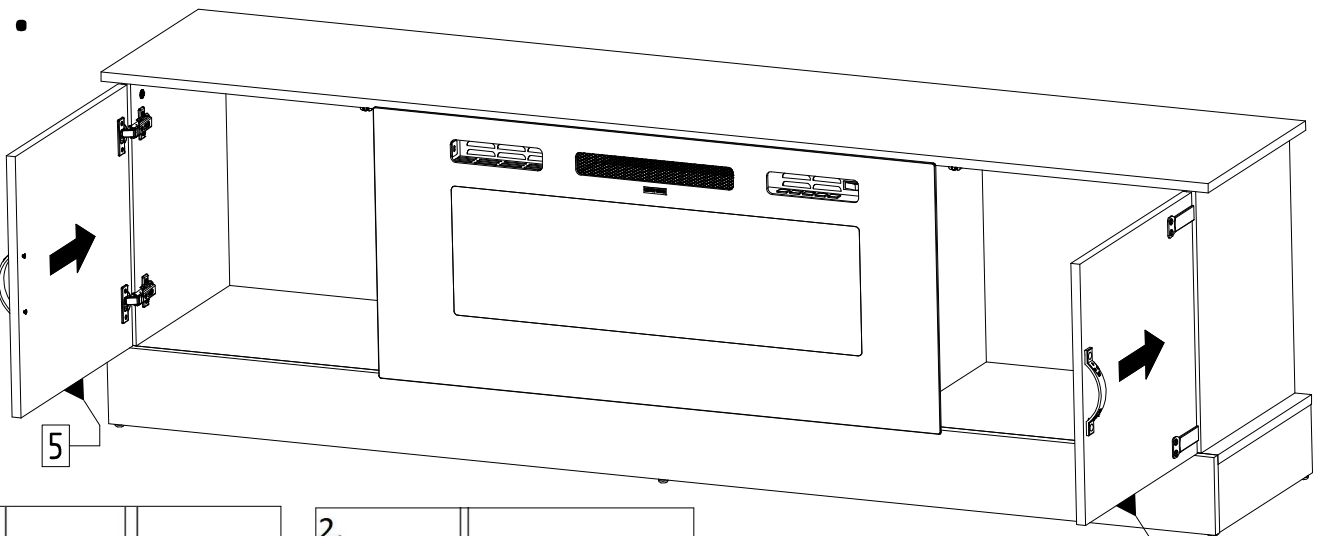

5

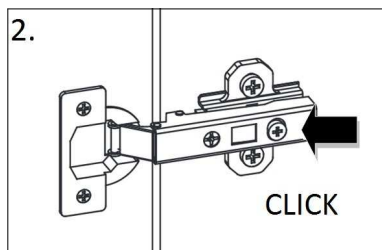
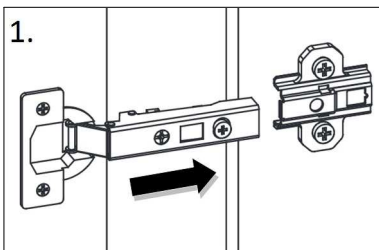

18.

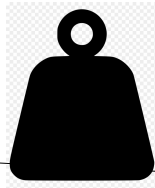
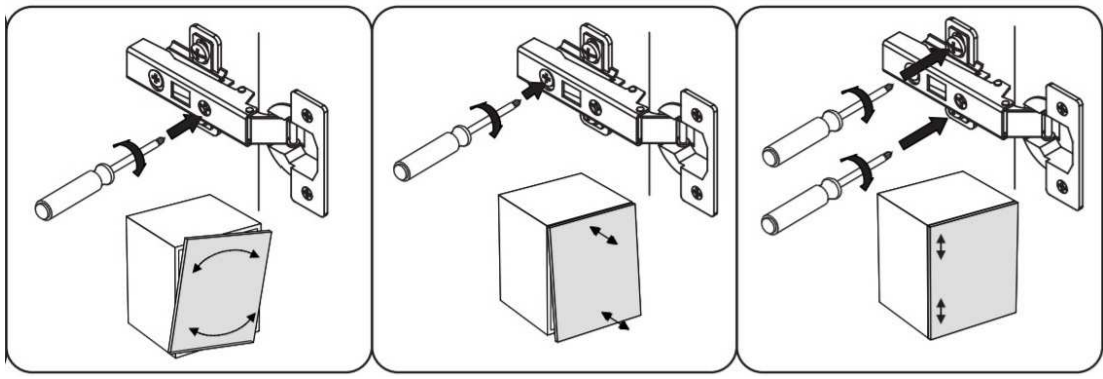

max.
25 kg

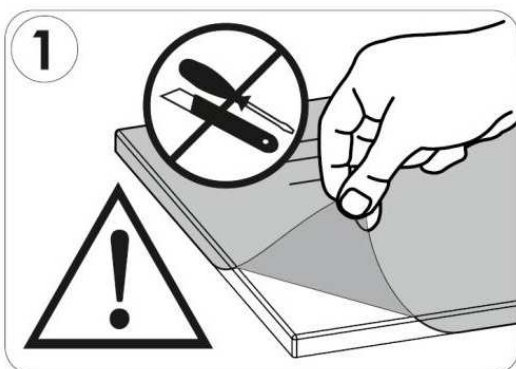
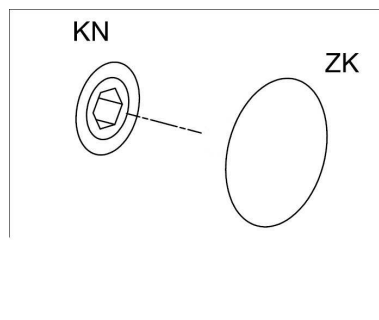
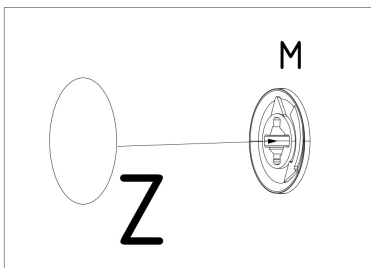
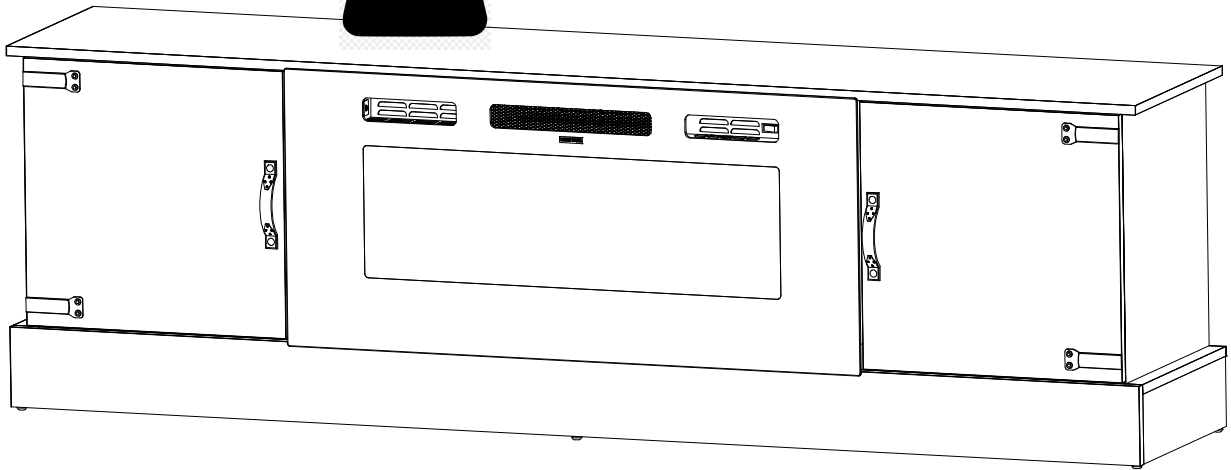

IMPORTANT SAFETY INFORMATION

ELECTRIC FIREPLACE SAFETY INFORMATION AND WARNING

ATTENTION: This Safety Information and Warning provides basic information for using an electric fireplace insert safely. Failure to follow the recommendations and warnings below may result in risk of fire, electric shock, and injury to person and property.

- **WARNING!** There's a risk of fire, electric shock, and injury to person if you don't follow the included instruction and safety information. We are not liable for any damages or injury caused by mishandling, improper installation, or improper use of the electric fireplace insert.
- **WARNING!** Prior to using your electric fireplace insert, compare the rated power of the electric fireplace insert to the capacity of the electrical circuit you plan to use it within. In order for the electric fireplace insert to be safely used, the electric fireplace insert's electrical demand, in addition to the electrical demand of any other electric devices using the circuit, should be well within the electrical capacity of the circuit. If you are unsure of the electrical capacity of the circuit, or the electrical demand of devices using the circuit, contact a licensed electrician for assistance.
- **WARNING!** Your electric fireplace insert may require a dedicated electrical circuit. Check with your local building codes.
- **WARNING!** To avoid electrical shock, do not open the back panel of the insert unless the power has been turned off and the insert has been unplugged.
- **WARNING!** The electric fireplace insert must be used on an AC supply only, and the voltage marked on the heater must correspond to the supply voltage.
- **WARNING!** Any repairs or modifications done to this electric fireplace insert are not recommended, and may cause an increased risk of fire, electric shock, and injury to person. Any repairs or modifications will void all warranty and technical support for this unit. If the decision of the user of the electric fireplace insert is to repair or modify the insert or any electrical wiring, such repairs or modifications should be done only by a licensed electrician, and must comply with local building codes.

- **WARNING!** Discontinue the use of this electric fireplace if any of the following has occurred:
 - Water damage
 - Insert has been damaged or dented
 - Power cord has become broken
 - Power cord has become too hot to touch
 - Insert smokes or smells like smoke (Note: When the heater function is used for the first time, a slight odor may be present. This is normal and should not occur again unless the heater is not used for an extended period of time.)
- **WARNING!** Do not cover or obstruct the insert in any way. The insert will overheat if covered.
- **WARNING!** Never immerse the product in water or any other liquids.
- **WARNING!** Do not run cables under carpets or rugs. Do not allow the main cables to hang over the sharp edges of the electric fireplace insert. Do not allow the main cables to come into contact with hot surfaces. From time to time, check the cable for damage. Never use the electric fireplace insert if the cable or any part of the insert shows signs of damage.
- **WARNING!** Do not switch the electric fireplace insert on until it has been properly installed as described in the instruction manual. Do not leave the electric fireplace insert unattended during use.
- **WARNING!** Keep the electric fireplace insert out of the reach of children. Do not let children operate the electric fireplace insert.
- The electric fireplace insert is fitted with a safety cut-off which will trigger if the insert overheats (e.g. due to blocked air vents). For safety reasons, the insert will NOT automatically reset. To reset the electric fireplace insert, disconnect the insert from the power supply for at least 15 minutes. After 15 minutes, reconnect the insert to the power supply and switch the insert on.

SAVE THIS SAFETY INFORMATION AND WARNING FOR FUTURE REFERENCE

IMPORTANT SAFETY INFORMATION

WALL MOUNTING FURNITURE SAFETY INFORMATION AND WARNING

ATTENTION: This article provides basic information for mounting your wall mounted floating furniture to a wall using a wall mount bracket.

- **WARNING!** There's a risk of damage to your furniture and wall and injury to person if you don't follow the assembly or installation instructions correctly. We're not liable for any damages or injury caused by mishandling or improper installation of the wall-mount bracket.
- **WARNING!** If you use substitute items other than the supplied screws, the furniture may fall and cause physical injury to someone or damage to the furniture and/or wall.
- **WARNING!** Do not attempt to mount furniture that is not sold as wall mounting furniture.
- We strongly recommend that a qualified professional install your furniture on the wall for product protection and safety reasons. Sufficient expertise is required to determine the strength of the wall for withstanding the furniture's weight.
- Check the wall-mount installation manual supplied with your furniture for information on how to properly mount your furniture. Product manuals are posted on our website
- We don't guarantee the use of third-party wall mount brackets or screws.
- Use the screws supplied with the wall-mount bracket when you attach the wall-mount bracket to the furniture.
- Any repairs or modifications done to the included wall mount bracket or any part of the wall mounted furniture are not recommended, and may cause an increased risk of damage to your furniture and wall, and potentially injury to person. Any repairs or modifications will void all warranty and technical support for this unit.

SAVE THIS SAFETY INFORMATION AND WARNING FOR FUTURE REFERENCE

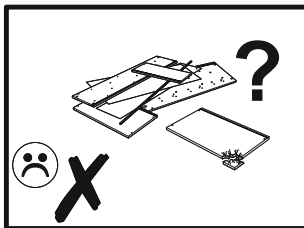
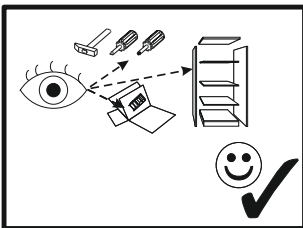

D: ALLGEMEINE HINWEISE FÜR MÖBEL AUS HOLZ UND HOLZWERKSTOFFE: MELAMIN, LAMINAT, ARMATURENBRETT
Zu reinigen, verwenden Sie ein feuchtes Tuch. Verwenden Sie nur Wasser oder ein mildes Reinigungsmittel. Wischen Sie mit einem Tuch trocken.

GB: GENERAL INSTRUCTIONS FOR FURNITURE OF WOOD AND WOOD MATERIALS: MELAMINE, LAMINATE, DASHBOARD
To clean, use a damp cloth. Use only water or a mild detergent. Wipe dry with a cloth.

ES: INSTRUCCIONES GENERALES PARA MUEBLES DE MADERA Y MATERIALES: MELAMINA, LAMINADO, TABLERO DE INSTRUMENTOS
Para limpiar, utilice un paño húmedo. Utilice sólo agua o un detergente suave. Seque con un paño

FR: INSTRUCTIONS GENERALES DE MEUBLES DE MATÉRIAUX DE BOIS ET: MÉLAMINÉS, STRATIFIÉS, TABLEAU DE BORD
Pour nettoyer, utilisez un chiffon humide. d'eau ou d'un détergent doux. Essuyer avec un chiffon.

CZ: VŠEOBECNÉ POKYNY PRO NÁBYTEK ZE DŘEVA A DŘEVĚNÝCH MATERIÁLŮ: MELAMINE, LAMINÁT, DASHBOARD
K čištění použijte vlhký hadřík. Používejte pouze vodu nebo jemným čistícím prostředkem. Vytřete do sucha hadříkem.

PL: OGÓLNE INSTRUKCJE DOTYCZĄCE MEBLI Z DREWNA ORAZ MATERIAŁÓW DREWNOPOCHODNYCH: MELAMINA, LAMINAT, OKLEINA
Do czyszczenia należy używać wilgotnej ściereczki. używać wyłącznie wody lub delikatnego detergentu. Wycierać do sucha ściereczką.

HU: A BÚTOR ÁLTALÁNOS FAANYAGOK ÉS FAIPARI ANYAGOK: MELAMIN, LAMINÁT, MÚSZERFAL
A tisztításhoz használjon egy nedves ruhával. Csak vizet vagy enyhe tisztítószerrel. Töröld szárazra egy ronggyal.

HU: A BÚTOR ÁLTALÁNOS FAANYAGOK ÉS FAIPARI ANYAGOK: MELAMIN, LAMINÁT, MÚSZERFAL
A tisztításhoz használjon egy nedves ruhával. Csak vizet vagy enyhe tisztítószerrel. Töröld szárazra egy ronggyal.

SK: VŠEOBECNÉ POKYNY PRO NÁBYTEK ZE DŘEVA A DŘEVĚNÝCH MATERIÁLŮ: MELAMINE, LAMINÁT, DASHBOARD
Na čistenie použite vlhkú handričku. používajte iba vodu alebo jemným čistiacim prostriedkom. Vytrite dosucha handričkou.

RU: ОБЩИЕ ПРАВИЛА ДЛЯ МЕБЕЛИ ДРЕВЕСИНЫ И ДРЕВЕСНЫХ МАТЕРИАЛОВ: МЕЛАМИН, ЛАМИНАТ, ПАНЕЛЬ
Для очистки используйте влажную ткань. Используйте только воду или мягкое моющее средство. Протрите сухой тряпкой.

IT: ISTRUZIONI GENERALI PER MOBILI DI LEGNO E LEGNO MATERIALI: MELAMINICO, LAMINATO, CRUSCOTTO
Per la pulizia, utilizzare un panno umido. Utilizzare solo acqua o un detergente neutro. Asciugare con un panno.

RO: INSTRUCȚIUNI GENERALE DE MOBILIER DE LEMNOASA ?I MATERIALE LEMNOASE: PAL, LAMINAT, TABLOU DE BORD
Pentru a curăța, folosiți o carpa umeda. Folosiți numai apa sau un detergent slab. Stergeți cu o carpa.

TR: AHŞAP VE AHŞAP MALZEMELERIN MOBİLYA İÇİN GENEL BİLGİLER: MELAMIN, LAMINAT, PANEL
Temizlemek için, nemli bir bez kullanın. Sadece su veya hafif bir deterjan kullanın. Bir bez ile kurulayın.

NL: ALGEMENE RICHTLIJNEN VOOR MEUBELEN VAN HOUT EN HOUTPRODUCTEN MATERIALEN: MELAMINE, LAMINAAT, DASHBOARD
Schoon te maken, gebruikt u een vochtige doek. Gebruik alleen water of een mild schoonmaakmiddel. Veeg met een doek droog.

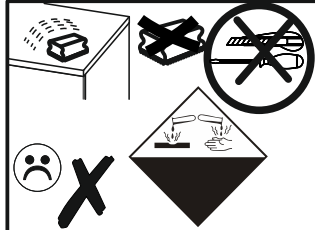
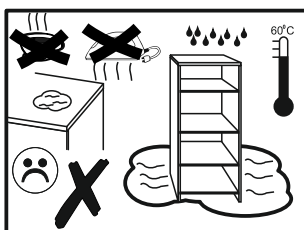
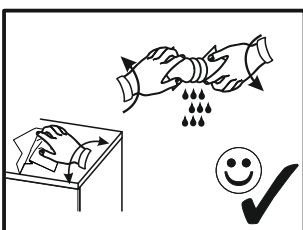
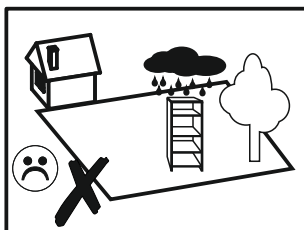
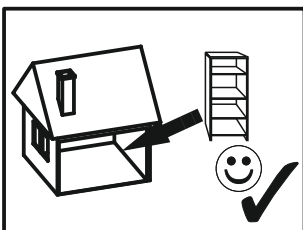
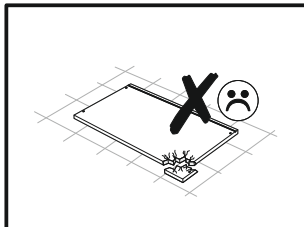
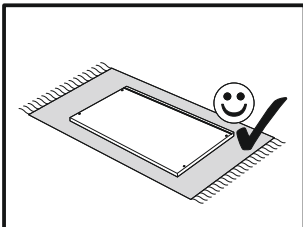
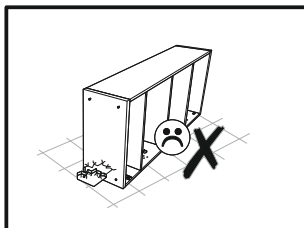
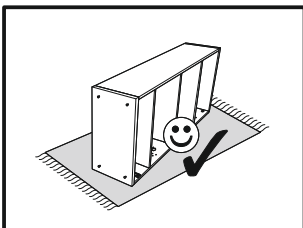
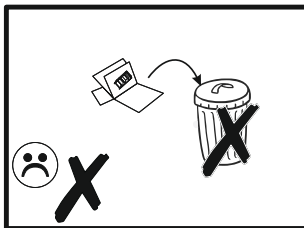
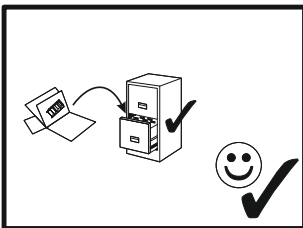

PL: Komplementowanie akcesorii oraz proces pakowania odbywa się pod nadzorem kontroli jakości oraz monitoringu.

EN: Complementing the accessories and the packaging process is carried out under the supervision of quality control and monitoring.

DE: Die Ergänzung des Zubehörs und des Verpackungsprozesses erfolgt unter der Aufsicht der Qualitätskontrolle und -überwachung.

FR: Le complément des accessoires et du processus d'emballage s'effectue sous la supervision d'un contrôle et d'une surveillance de la qualité.

