

# Dimension/Specification

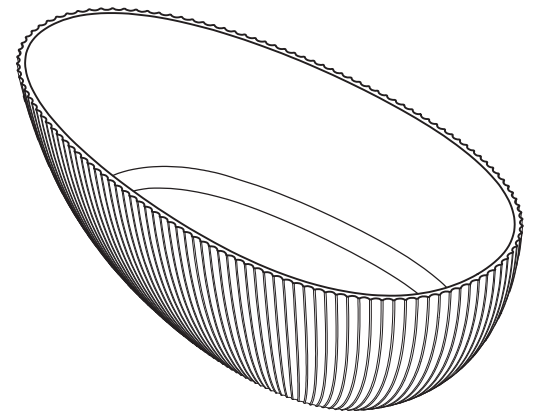
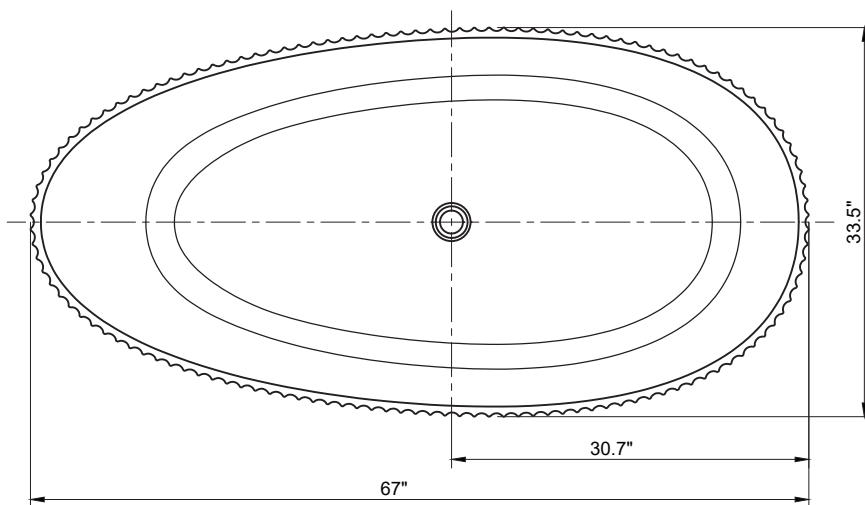
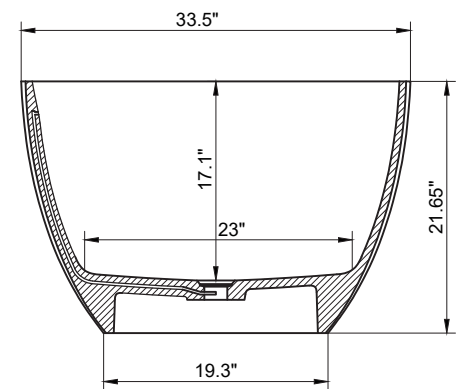
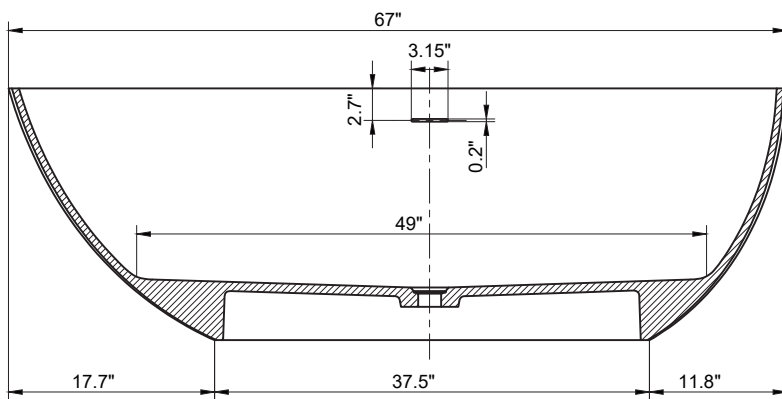

Sku RX-S23-67