



**Whynter Grande 40 Quart Capacity Counter-Top Multi-Function
Intelligent Convection Steam Oven Air Fryer,
Oven, Yogurt Maker, Dehydrator & DIY Mode**

Model # : TSO-488GB



Congratulations on your new Whynter product. To ensure proper operation, please read this Instruction Manual carefully before using this product. Keep this manual in a safe place for future reference.

DISPOSAL INFORMATION

Thank you for choosing Whynter. Please follow the instructions provided in this user manual to obtain the very best performance from your steam oven. We trust that your Whynter steam oven will provide the performance and reliability that we stand for.

Please keep this user manual in a safe place for future reference.

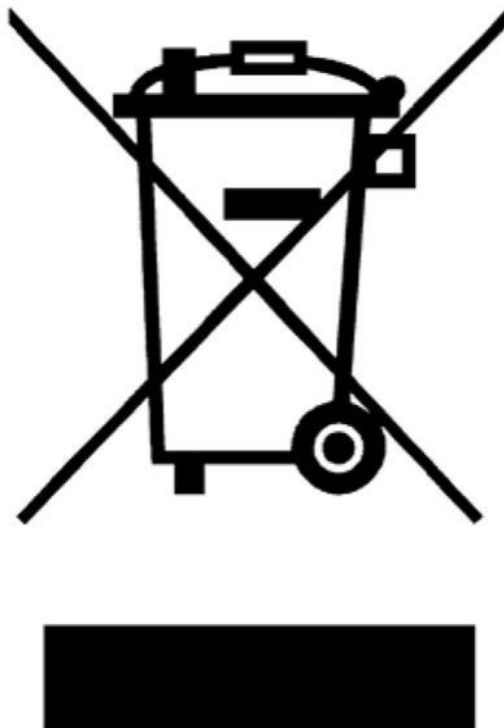

This symbol on the product or its packaging indicates that this appliance cannot be treated as normal domestic trash, but must be handed in at a collection point for recycling electric and electronic appliances. Your contribution to the correct disposal of this product protects the environment.

Further information about the recycling of this product can be obtained from your local municipal authority.

Table of Contents

	PAGE
SAFETY PRECAUTIONS	4
BEFORE FIRST USE	5
INTRODUCTION	6
PRODUCT DIAGRAM	7
CONTROL PANEL / DISPLAY	8 - 10
OPERATING INSTRUCTIONS	10 - 11
DIY FUNCTION MODES	12 - 13
MENU SELECTIONS	14 - 16
TIPS	16
CLEANING AND MAINTENANCE	17
SPECIFICATIONS	17
TROUBLESHOOTING	18
WARRANTY	19

SAFETY PRECAUTIONS

1. Read all instructions.
2. UNPLUG FROM OUTLET WHEN NOT IN USE before putting on or taking off parts and before cleaning. Allow to cool before cleaning or handling.
3. Do not touch hot surfaces. Use handles or knobs.
4. To protect against electrical shock, do not immerse cord or plug, or place any part of the steam oven in water or other liquids.
5. Close supervision is necessary when used by or near children.
6. Do not operate with a damaged cord or plug or after the appliance has malfunctioned or has been dropped or damaged in any way or is not operating properly.
7. The use of accessory attachments not recommended by Whynter may cause injury.
8. Do not use outdoors.
9. Do not let the cord hang over the edge of the table or countertop where it could be pulled on inadvertently by children or pets. Do not let the cord touch hot surfaces, which could damage it.
10. Where applicable, always attach the plug to appliance and check that the cooking cycle has stopped before plugging cord into wall outlet. To disconnect, press the Power button to stop the cooking cycle, then remove plug from wall outlet.
11. Do not place oven on or near a hot gas or electric burner or in a heated oven.
12. Do not use this oven for anything other than its intended purpose.
13. Do not place sealed or airtight containers in the oven.
14. Extreme caution should be exercised when using containers constructed of materials other than metal, glass or ceramic in the oven.
15. To avoid burns, use extreme caution when removing trays, pans, racks, or disposing of hot grease.
16. When not in use, always unplug the unit. Do not store any materials other than Whynter's recommended accessories in this oven.
17. Do not place paper, cardboard, plastic or similar products in the oven.
18. Do not cover crumb tray or any part of the oven except the baking pan with metal foil. This will cause overheating of the oven.
19. Do not block the top of the oven, steam vents, or any other openings while in use.
20. Oversize foods, metal foil packages and utensils must not be inserted in the oven, as they may involve a risk of fire or electric shock.
21. A fire may occur if the oven is covered or touching flammable materials such as curtains, draperies, walls and the like when in operation. Do not store any items on top of the appliance when in operation. Do not operate under wall cabinets.
22. Do not clean with metal scouring pads. Pieces can break off the pad and touch electrical parts, involving a risk of electric shock.
23. Do not attempt to dislodge food when the oven is plugged into an electrical outlet.
24. CAUTION: To avoid possibility of fire, never leave oven unattended during use.
25. Do not rest cooking utensils or baking dishes on glass door.
26. Where applicable, always attach plug to appliance and check that the cooking cycle is stopped before plugging cord into wall outlet. To disconnect, press the Power button to stop the cooking cycle, then remove plug from wall outlet.
27. Do not operate your appliance in an appliance garage or under a wall cabinet. When storing in an appliance garage always unplug the unit from the electrical outlet. Not doing so could create a risk of fire, especially if the appliance touches the walls of the garage or the door touches the unit as it closes.
28. Extreme caution must be used when moving an appliance containing hot oil or other hot liquids.

SPECIAL CORDSET INSTRUCTIONS

- A short power supply cord is provided to reduce the risks resulting from becoming entangled in or tripping over a longer cord.
- Extension cords may be used if care is exercised in their use.
- If an extension cord is used, the marked electrical rating of the extension cord must be at least as great as the electrical rating of the appliance, and the longer cord should be arranged so that it will not drape over the countertop or tabletop where it can be tripped over unintentionally or pulled on by children.

UNPACKING INSTRUCTIONS

1. Place the box on a large, sturdy, flat surface.
2. Open the box and remove the instruction book and any other literature.
3. Lift the packing materials, oven and accessories out of the box.
4. Remove any other items and remove packing materials surrounding those parts.
5. Remove any protective or promotional labels from your steam oven and other parts.
6. Retain packaging.

FOR HOUSEHOLD USE ONLY. SAVE THESE INSTRUCTIONS

BEFORE THE FIRST USE

- Before using your Whynter steam oven for the first time, remove any dust from shipping by wiping the base, cover and controls with a damp cloth.
- Be sure to thoroughly clean all accessories before first use. Rinse water reservoir in hot, sudsy water. Be sure to thoroughly clean all accessories before each use.
- Do not use on heat-sensitive surfaces.
- **DO NOT STORE ITEMS ON TOP OF THE OVEN. IF YOU DO, REMOVE THEM BEFORE YOU TURN YOUR OVEN ON. THE EXTERIOR WALLS GET VERY HOT WHEN IN USE.**
- **KEEP OUT OF REACH OF CHILDREN.**

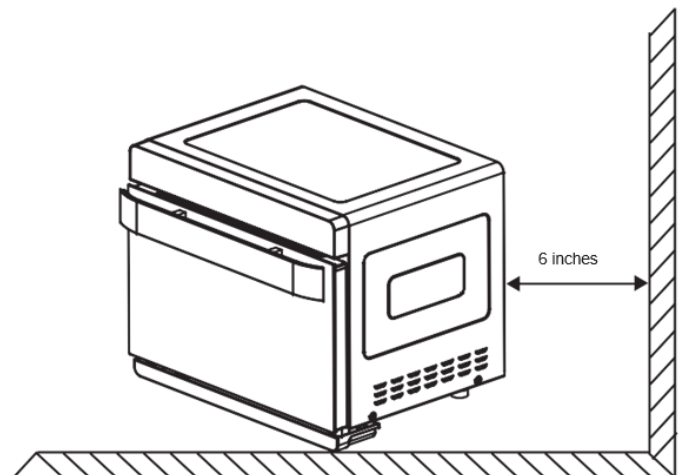
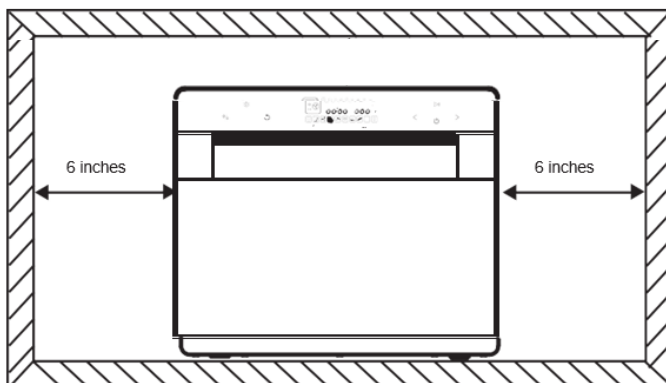

A clearance of at least 6 inches shall be reserved on the back and two sides and over the product when the product is placed. Do not place any item on the product.

INTRODUCTION

What Is a Steam Oven?

Steam ovens are just what they sound like – ovens that use hot steam rather than hot air to cook food. They introduce a whole new level of cooking to your kitchen, and can even reheat things more effectively than microwaves, making them an awesome double whammy for your home. You can use a steam oven in place of a standard convection oven, or double it up with your existing oven for even more range and cooking power.

How Do Steam Ovens Work?

Most steam ovens work by siphoning water from a small water tank into a built-in boiler, heating it to 212 degrees Fahrenheit, and releasing the steam into the oven. This superheated steam is just as effective at cooking your food through as the circulated hot air that makes convection work, and is often even faster.

Steam cooking is healthier than traditional cooking using microwave and traditional oven. The steam helps lock moisture into whatever food is being cooked or reheated, eliminating the need for extra oils and fats to keep food moist. No more getting trapped in the kitchen basting that turkey to keep it from drying out! It also help to retain the food's natural vitamins and minerals.

Steam ovens are generally considered to be healthier than standard ovens. The steam helps lock moisture into whatever food is being cooked or reheated, eliminating the need for extra oils and fats to keep food moist. No more getting trapped in the kitchen basting that turkey to keep it from drying out! They also help your food retain its natural vitamins and minerals, so you get the most nutritional value from your food.

PRODUCT STRUCTURAL DESIGN

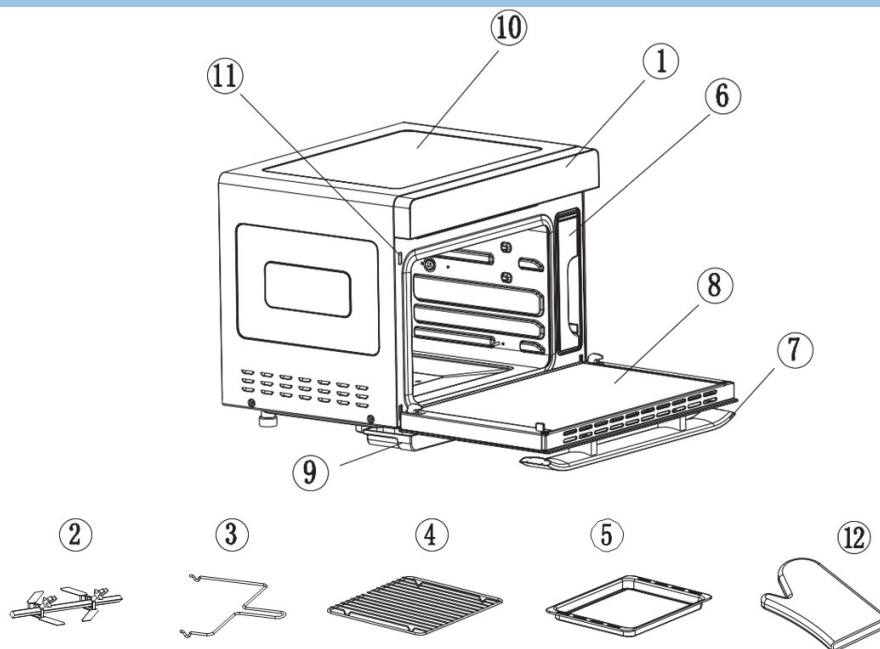

1. Control Panel	7. Handle
2. Fork Assembly	8. Door
3. Fork Handle	9. Water Tray
4. Broiling/Steaming Rack	10. Oven Body
5. Baking Pan	11. Door Switch
6. Water Tank	12. Oven Mitt



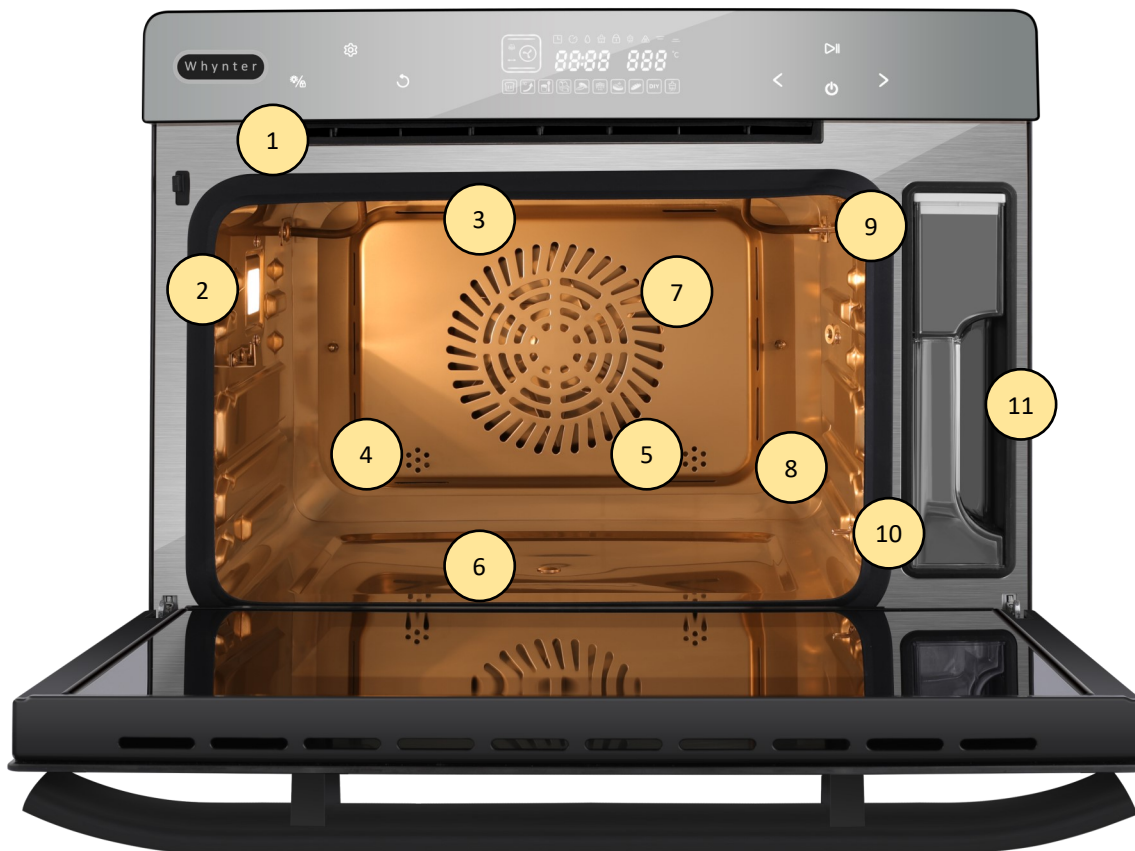



PRODUCT DIAGRAM



1. Residual Steam Outlet	6. Bottom Heater
2. Oven Lamp	7. Internal Fan
3. Top Heater	8. Air Inlet
4. Steam Inlet	9. Temperature Sensor
5. Steam Inlet	10. Temperature Sensor
11. Water Tank	

CONTROL PANEL



	Icon	Function Description
1		<p>Oven lamp/child lock key:</p> <ul style="list-style-type: none"> • Press to toggle Oven Lamp ON or OFF • Oven lamp will remain ON for three minutes after function completion. • Oven lamp will remain ON for three minutes when the oven door is left opened. • To activate Child Lock, press and hold down the child lock key for three seconds in standby mode. To deactivate the child lock, press and hold the child lock key again.
2		<p>Setting key: Preset and Time-delay</p> <p>During any program selection or in standby mode, press the Setting Key to select desired preset and time-delay settings.</p>
3		<p>Back key:</p> <p>Press the Back key to return to the previous setting mode.</p>
4		<p>Selection key (Reverse function) :</p> <ul style="list-style-type: none"> • Toggle between 9 DIY regular function modes and 10 specific operation modes in a reverse sequence. • Press to adjust the time and temperature.
5		<p>ON/OFF key:</p> <p>Press ON/OFF key to toggle between ON and OFF operation mode.</p>
6		<p>Selection key (Forward function):</p> <ul style="list-style-type: none"> • Toggle between 9 DIY regular function modes and 10 specific operation modes in a forward sequence. • Press to adjust the time and temperature.
7		<p>ENTER key:</p> <p>Press ENTER key to Start, Pause, or confirm desired selection.</p>







DISPLAY



	Function	Description
	Cooking Time	Displays cooking hours and minutes.
	Temperature	Displays adjustable temperature range: 85°F - 450°F
	Preset function	Icon indicates that steam oven is running on Preset mode. Preset time can be adjusted in one hour increments, from 0-24 hours.
	Time-delay	Icon indicates that steam oven is running on time-delay mode.
	Water level	Icon is always on in Steam mode. Flashing icon indicates low water level in water tank.
	Water tray cleaning	Icon indicates water tray needs to be cleaned.
	Child lock	Icon indicates control panel is locked.
	Descaling	Icon indicates descaling cycle is on.
	Top heater pipe	Icon indicates top heater pipe is on.
	Bottom heater pipe	Icon indicates bottom heater pipe is on.
	High temperature	Icon indicates temperature is high in the oven and caution is needed.
	Ferment	Icon indicates Ferment function is on. Mode: Top heater pipe Adjustable temperature: 85°F – 115°F Adjustable time: 0-7 hours
	Preheat	Icon indicates Preheat function is on. Mode: Back heater convection Default temperature: 360°F Unit will shut off once oven reaches 360°F.
	Yogurt	Icon indicates Yogurt making function is on. Mode: Steam Default temperature: 115°F Default time: 8 hours
	Air Fryer	Air Fryer menu contains 9 programs and recipes. Refer to page 14. Mode: Back heater convection

DISPLAY







	Dried fruit and nuts	Dry fruit and nuts menu contains 9 programs and recipes. Refer to page 15. Mode: Back heater convection or Top & bottom heater pipes
	Steam	Steam menu contains 9 programs and recipes. Refer to page 14. Mode: Steam
	Roast	Roast menu contains 9 programs and recipes. Refer to page 14. Mode: Multiple
	Bake	Bake menu contains 9 programs and recipes. Refer to page 14. Mode: Top & bottom heater pipes
	DIY (Do It Yourself)	Icon indicates DIY function is on. Mode: Choose from 9 function modes
	Descaling	Icon indicates Descaling function is on. Descaling function helps to remove residual buildup. Default time: 50 minutes (program cannot be paused)

OPERATING INSTRUCTIONS

1. Powering on

Press the Power  button to turn the oven on. It will enter a full-screen standby mode after a beep. If there is no selection in three minutes, the unit will return to standby mode.

2. Menu Selection

In the standby model, press the selection key   to select a function. The default function is  Steam. Press the Enter  button to confirm the selection. A beep will sound and the clock will start counting down. Choose any of the pre-program functions or the DIY function.

For example, to select Top heater pipe mode.

- 1) Select DIY then  button to confirm. Then select Top heater pipe and press  button to confirm.

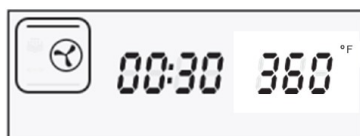

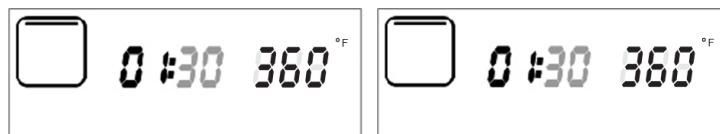

OPERATING INSTRUCTIONS

- 2) Select a cooking time by confirming the blinking numbers (hours & minutes).

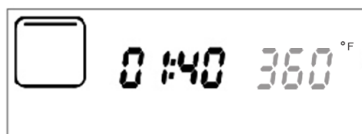

- 3) Select a temperature by confirming the blinking number temperature.





- 4) Press the Enter  button to begin the cooking cycle.
The countdown timer will begin counting down until the cooking cycle has completed.



NOTE: The timer will stop when the door is open, and the timer will flash. Once the door is closed, timer will resume.

3. During Operation

Pause function

During the cooking process, you can stop the timer and cooking function by pressing the Enter  button. Press the Enter  button again to resume the timer and cooking function.

Add time/ Adjust temperature

During the cooking process, the LED screen will display the countdown timer. Press and hold the Setting  button until the Time-delay  icon appears on the display. The minute number will flash and it can be adjusted by pressing the < or > buttons. Press the Enter  button to confirm the change.









NOTE: The cooking hour is not adjustable during operation.

4. Cooking Complete Reminder

Once the cooking process is finished, END will appear on the display and the unit will beep 10 times. The High temperature icon  will be displayed if the oven temperature is above 120°F and the internal fan will run for 3 minutes to circulate the hot air inside.

NOTE: After the steam program is completed, the water tray cleaning  icon will flash for 1 minute to indicate the residual water inside the oven needs to be wiped and that the water tank needs to be drained. To remove excess liquid, slide the drip tray out and discard the contents. Never operate the oven without the drip tray in place.

DIY FUNCTION MODES

	Steam
	Strengthening heating (Back heater convection + top heater pipe + bottom heater pipe)
	Top heater pipe
	Top/bottom heater pipe
	Hot air convection (Top heater pipe + rear fan)
	Back heater convection Air Fryer (Back heating + rear fan)
	High-temperature steaming (steam + Back heater convection)
	Back heater convection + turning fork
	Top heater pipe + turning fork

DIY Steam mode

Before starting the Steam function, fill the water reservoir with distilled or filtered water. Open the oven door and remove the water tank to fill the water to its maximum level then put the water tank back in place.

Press the selection key > and choose the Steam mode. The Steam icon will flash then press the Enter ▷|| button to confirm the selection. Press the selection key > to select the operation hour time (default value is 0, ranging from 0 - 6) and minute (default value is 30, ranging from 0 - 59). Press the Enter ▷|| button to confirm the selection. The temperature numbers will flash, press the selection key > to select desired temperature (120-230°F).

If the water tank is not in place or runs out of water, the oven will beep and the Water level  icon will flash.

NOTE: After the steam program is completed, the water tray cleaning  icon will flash for 1 minute to indicate the residual water inside the oven needs to be wiped and that the water tank needs to be drained. To remove excess liquid, slide the drip tray out and discard the contents. Never operate the oven without the drip tray in place.

DIY FUNCTION MODES



Press the selection key > and choose the desired cooking mode. The function icon will flash, press the Enter ▷ button to confirm the selection. Press the selection key > to select the operation hour time (default value is 0, ranging from 0 - 6) and minute (default value is 30, ranging from 0 - 59). Press the Enter ▷ button to confirm the selection. The temperature numbers will flash, press the selection key > to select desired temperature.

NOTE: You can set different temperatures for the Top & Bottom heater pipes separately.









Once the cooking process is finished, END will appear on the display and the unit will beep 10 times. The High temperature icon  will be displayed if the oven temperature is above 120F and the internal fan run for 3 minutes to circulate the hot air inside.

MENU SELECTIONS









Steam Menu

Code	E-1	E-2	E-3	E-4	E-5	E-6	E-7	E-8	E-9
Food Style	Steamed Vegetable	Steamed Rice	Steamed Fish	Steamed Shrimp	Steamed Crab	Steamed Eggs	Steamed Chicken	Steamed Papaya	Steamed Potatoes
Heating time (minute)	16	50	20	15	30	16	30	35	50
Heating temp. (°F)	210	210	210	210	210	210	210	210	210









Roast Menu

Code	F-1	F-2	F-3	F-4	F-5	F-6	F-7	F-8	F-9
Food Style	Roast Chicken	Roast Steak	Roast Muttons	Roast Salmon	Roast Chicken Legs	Roast Saury	Roast Potatoes	Roast Shrimp	Roast Sausages
Heating time (minute)	45	12	35	20	26	20	13	15	10
Heating temp. (°F)	450	450	395	430	395	430	430	360	395
Operating Panel									

Bake Menu

Code	H-1	H-2	H-3	H-4	H-5	H-6	H-7	H-8	H-9
Food Style	Baguette bread	Wheat bread	Pizza	Yogurt cheese cake	Chiffon cake	Chocolate cake	Cookies	Puff	Egg tart
Heating time (minute)	16	20	22	60	50	50	14	32	22
Heating temp. (°F)	360	360	360	300	300	300	360	360	360
Operating Panel									

Air Fryer Menu

Code	P-1	P-2	P-3	P-4	P-5	P-6	P-7	P-8	P-9
Food Style	Pork Chops	Chicken Wings	Chicken Kabobs	Onion Meatballs	Pita Chips	Chips	Croutons	Mini Pizza	Bacon
Heating time (minute)	20	23	18	18	7	13	14	18	15
Heating temp. (°F)	410	395	355	410	430	430	285	355	395
Operating Panel									

MENU SELECTIONS

Dry Fruit and Nuts Menu



Code	L-1	L-2	L-3	L-4	L-5	L-6	L-7	L-8	L-9
Food Style	Dried Banana	Dried Apple	Dried Raisins	Dried Kiwi	Dried Lemon	Almonds	Walnut	Macadamia Nut	Cashew Nut
Heating time (minute)	360	360	420	360	360	10	12	12	12
Heating temp. (°F)	150	150	195	150	150	285	320	320	320
Operating Panel									

Other Functions

Descaling Function



When the steam generator operates, there is an accumulation of limestone inside because of calcium content in the water. Periodic descaling of residual buildup can increase the life span of your oven and prevent any decline in performance.

When the operation time reaches 100 hours, the descaling icon on the screen will flash to remind you to run the descaling cycle.



1. Remove all accessories from inside the oven.
2. Make approximately 180 ml descaling solution using white vinegar with 1.2 liters distilled/ filtered water and pour it into the water tank.
3. Press the selection key > to select the Descaling function and then press the ENTER ▷|| button to start the descaling operation.
4. When 20 minutes are left in the descaling operation, the oven will prompt you to remove the water tank and drain the descaling solution. Replace the water tank with clean distilled/ filtered water.
5. After the water tank is replaced with clean water, close the oven door and the descaling operation will resumes. When there are 10 minutes remaining in the descaling operation, the oven will prompt you to remove the water tank, drain the water and replace it with clean distilled/ filtered water.
6. Once the descaling operation completes in 50 minutes, wipe away any moisture inside of the oven with a dry cloth. Let it dry fully with the door open.

MENU SELECTIONS

Light

Press the Light  button to turn the oven interior light on or off.

Child Lock

Press and hold the Child Lock  button for 3 seconds to activate the child lock. To deactivate the child lock, press and hold the Child Lock  button for 3 seconds

Water level detection

If the water tank is not in place or runs out of water, the oven will beep and the Water level  icon will flash. Open the oven door and remove the water tank to fill it with distilled or filtered water to its maximum level then put the water tank back in place.

Open/Close door protection

Operation of the oven will pause if the oven door is open; it will automatically resumes operation once the door is closed.

TIPS

General

Always make sure the drip tray is in place before cooking and to empty it after each use.

Always use distilled or filtered water.

Always remember to empty drip tray after each use. Also make sure it is in place before cooking.

Bake mode (Top & bottom heater pipe)

Bake mode is best used for most baked goods like cakes, cookies and pastries.

Bake Steam (High temperature steaming (steam + back heater convection))

The combination of bake and steam means crispy yet juicy results every time in less time. The Bake Steam function also provides even, moist heat that is a benefit for many types of foods, from perfect custards to effortless braised dishes.

If using a recipe meant for a traditional oven, begin checking for doneness at least 10 minutes before the recommended end time.

Steam

The highest temperature (230°F) on the Steam function should be used for all traditional steaming tasks like vegetables, seafood and other proteins.

The Steam function can also work to clean the interior of your oven. Run the Steam function at 230° F for 30 minutes to loosen grease or food residue. Once the cycle is complete, wipe the interior clean with a cloth.

Broil (Top heater pipe)

There are 2 different rack positions for Broil. The lower broil position is best suited for thicker foods like steaks, chops and larger fish fillets as well as top browning of dishes like nachos and casseroles. The upper broil position is for thin foods like smaller seafood and thin fillets. When positioning foods to broil make sure they are not touching the heating elements as they can burn very easily.

CLEANING AND MAINTENANCE

- Always turn the oven off and unplug the power cord from the outlet before cleaning.
- Avoid abrasive and metal pads when cleaning the bakeware with non-sticky coating.
- When cleaning the exterior, do not use abrasive cleansers. Simply wipe the exterior with a clean damp cloth and dry thoroughly.
- To clean the interior walls, you can first loosen food debris by running the Steam cycle function. Once the cycle has completed, wipe interior with a cloth or sponge. DO NOT use harsh abrasives or corrosive products, which could damage the oven wall surfaces.
- To remove excess liquid, slide the drip tray out and discard the contents. Never operate the oven without the drip tray in place.
- It is recommended to use distilled or filtered water. If tap water is used for a long period of time, there will be mineral scales on the inner walls of the oven.
- Rinse the water reservoir in hot water. Dry well.
- After cooking is completed, the residual water in the water tank should be removed.
- The oven door gasket should be cleaned frequently using a soft dry cloth.
- Any other servicing should be performed by an authorized service representative, unless noted by the manufacturer.

Note: If the oven is not in use for more than one month, fill water tank and run the oven using the Steam function at the highest temperature for 60 minutes before using.

SPECIFICATIONS

Power	120V 60Hz 1800W
Capacity	40 L
Water Tank	1.4 L
Housing	Stainless Steel
Door	Double-layer Glass Door
Control	LED display Touch Screen LED Display 4 Predefined Programs 5 Menus with 45 Predefined Recipes + 9 DIY Modes
Functions	Fermentation / Preheat / Make Yogurt / Air Fryer Menu / Food dehydrator Menu / Steam Menu / Roast Menu / Bake Menu / DIY mode / Descaling
Adjustable Temperature	85°F - 450°F
Heating modes	Steam / Top Heater / Bottom Heater / Back Heater Convection
Preset Time	up to 24 hours
Accessories	Rotisserie Set, Bakeware, Grill, Glove, User Manual, Recipe Guide
Specialty	Steamer, Electric Oven, Air Fryer, Food Dehydrator, Yogurt Maker, 5 in 1
Product dimension	20.7" W x 19.68" D x 17.32" H
Product Weight	48 lbs

TROUBLESHOOTING

Error	Possible causes	Solution
Er1	Open circuit for top sensor	Stop the work, open the oven door and allow the cavity to cool down for 10 minutes, and then restart it or contact Whynter Customer Support
Er2	Short circuit for top sensor	Stop the work, open the oven door and allow the cavity to cool down for 10 minutes, and then restart it or contact Whynter Customer Support
Er3	Open circuit for down sensor	Stop the work, open the oven door and allow the cavity to cool down for 10 minutes, and then restart it or contact Whynter Customer Support
Er4	Short circuit for down sensor	Stop the work, open the oven door and allow the cavity to cool down for 10 minutes, and then restart it or contact Whynter Customer Support
Er7	Open circuit for evaporating heater sensor	Contact Whynter Customer Support
Er8	Short circuit for evaporating heater sensor	Contact Whynter Customer Support
Display not working	Check whether the power cord is plugged into a working outlet Display panel has a loose connection	Check the outlet for power. Power off and unplug the unit for 5 minutes. Then restart. Contact Whynter Customer Support
Oven light does not illuminate	Oven light is damaged Loose Connection	Replace or contact Whynter Customer Support
Exhaust fan does not work	Loose Connection Fan is damaged	Replace or contact Whynter Customer Support
No response from the button	Display PCB damaged or defective	Contact Whynter Customer Support
No steam	Water pipe is blocked Evaporator heater is damaged Water intake system is damaged	Contact Whynter Customer Support
Steam oven does not work	Door is not closed completely Poor contact of door control switch	Contact Whynter Customer Support
Steam leakage from oven door	Door is not closed completely Door gasket is not in place or damaged Door structure is damaged or not assembled in place	Re-close the oven door Inspect door gasket and reposition if needed Contact Whynter Customer Support

ONE YEAR LIMITED WARRANTY

This WHYNTER product is warranted to the original owner, purchased from an authorized Whynter dealer within the 48 U.S. continental states, for one year from the original purchase date against defects in material and workmanship under normal residential usage. Should your WHYNTER product prove defective within one year from the date of purchase, contact Whynter's Customer Support team with the serial number and proof of purchase to make a warranty claim. A Return Authorization number must be issued before returning any parts or products. Parts or products received without a Whynter issued Return Authorization number will be refused. Under this warranty, Whynter will repair or replace any parts found defective with new or remanufactured parts or exchange the defective product with a new, refurbished, or remanufactured product at our discretion. All defective products and parts covered by this warranty will be repaired or replaced on a mail-in basis to Whynter's Service Center. This warranty is not transferable. After the expiration of the warranty, the cost of labor and parts will be the responsibility of the original owner.

After two months to one year, the customer will be responsible for the return freight cost to Whynter's Service Center. Please package the product carefully in its original packaging to avoid damage in transit. Whynter is not responsible for damage resulting from shipper mishandling or improper packaging. Please retain the original box and packaging materials.

THIS WARRANTY DOES NOT COVER:

- Acts of God, such as fire, flood, hurricanes, earthquakes and tornadoes.
- Improper power supply such as power surge, low voltage, defective household wiring or inadequate fuses.
- Use in commercial or industrial applications.
- Damage, accidental or otherwise, to the product while in the possession of a consumer not caused by a defect in material or workmanship.
- Damage caused by consumer misuse, tampering, lack of maintenance or failure to follow the care and special handling provisions in the instructions.
- Damage to the finish of the case, or other appearance parts caused by wear.
- Damage caused by repairs or alterations to the product by anyone other than authorized by the manufacturer.
- Removal, Replacement Packaging, Freight and Insurance cost for the warranty service.
- Products sold AS IS or from an unauthorized reseller.
- Products that have had their serial numbers removed or defaced.

DISCLAIMER OF IMPLIED WARRANTIES; LIMITATION OF REMEDIES

CUSTOMER'S SOLE AND EXCLUSIVE REMEDY UNDER THIS LIMITED WARRANTY SHALL BE PRODUCT REPAIR OR REPLACEMENT AS PROVIDED HEREIN. CLAIMS BASED ON IMPLIED WARRANTIES, INCLUDING WARRANTIES OF MERCHANTABILITY OR FITNESS FOR A PARTICULAR PURPOSE, ARE LIMITED TO ONE YEAR OR THE SHORTEST PERIOD ALLOWED BY LAW, BUT NOT LESS THAN ONE YEAR. WHYNTER SHALL NOT BE LIABLE FOR CONSEQUENTIAL OR INCIDENTAL DAMAGES SUCH AS PROPERTY DAMAGE AND INCIDENTAL EXPENSES RESULTING FROM ANY BREACH OF THIS WRITTEN LIMITED WARRANTY OR ANY IMPLIED WARRANTY. SOME STATES AND PROVINCES DO NOT ALLOW THE EXCLUSION OR LIMITATION OF INCIDENTAL OR CONSEQUENTIAL DAMAGES, OR LIMITATIONS ON THE DURATION OF IMPLIED WARRANTIES, SO THESE LIMITATIONS OR EXCLUSIONS MAY NOT APPLY TO YOU. THIS WRITTEN WARRANTY GIVES YOU SPECIFIC LEGAL RIGHTS. YOU MAY ALSO HAVE OTHER RIGHTS THAT VARY FROM STATE TO STATE.

To obtain service or information, contact
Whynter LLC via email at support@whynter.com or call
866-WHYNTER.

Product contents and specifications may change without notice.

Copyright © 2020
WWW.WHYNTER.COM