



PREMIER
COPPER PRODUCTS

MODEL NUMBER: KA30DB33229-SD5

CODE/STANDARD COMPLIANCE

* IAPMO/cUPC LISTED



- * Description: 33" Hammered Copper Kitchen Apron 30/70 Double Basin Sink with Short 5" Divider
- * Outer Dimension: 33" x 22" x 9"
- * Inner Dimension: Left: 9" x 19" x 9" | Right: 21" x 19" x 9"
- * Divider Height: 5"
- * Rim: Back, Left, Right - 1" / Apron Front - 2"
- * Drain Opening: 3.5"
- * Finish: Oil Rubbed Bronze | Living Copper

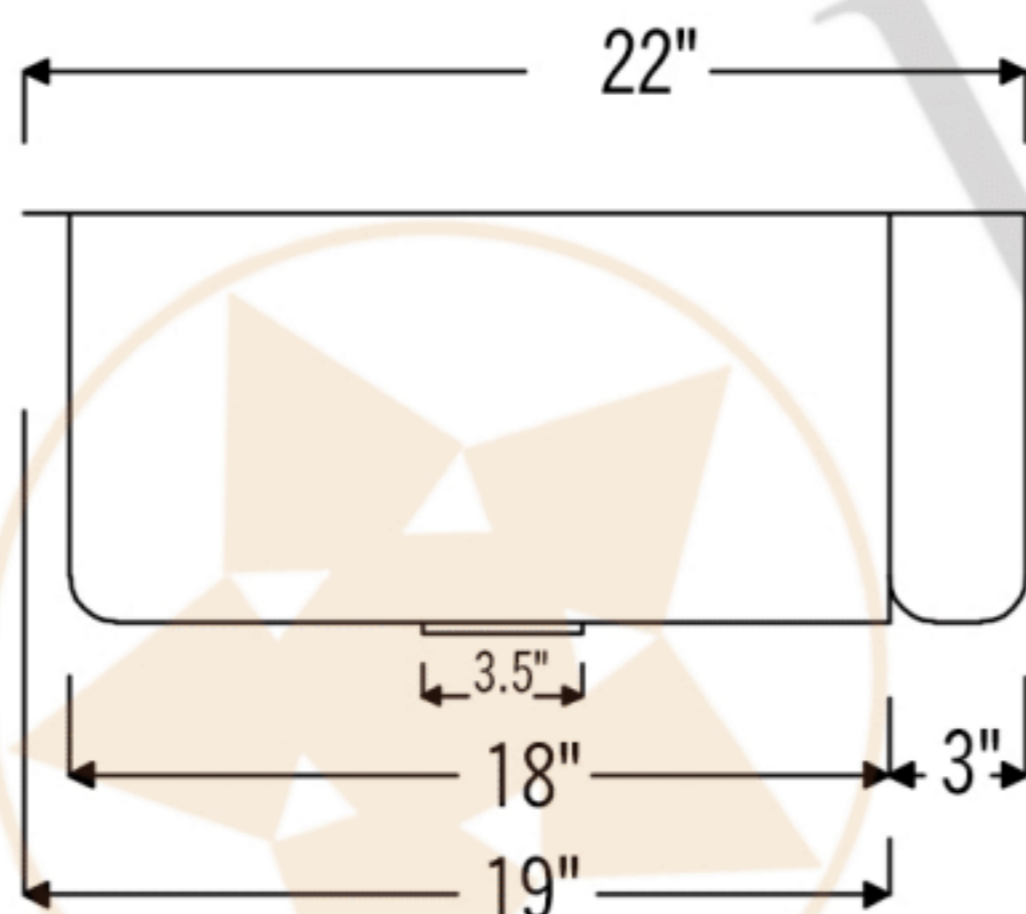
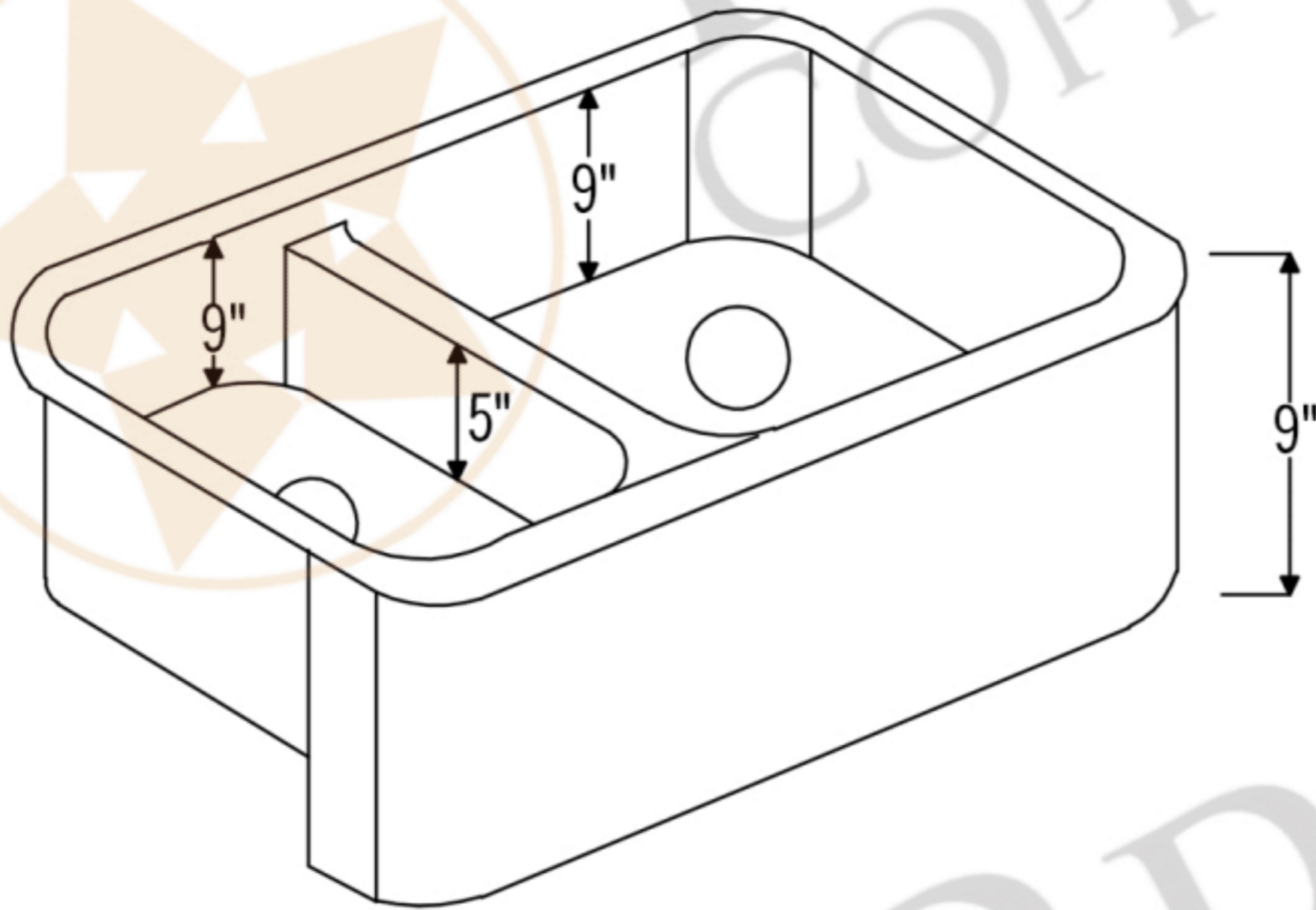
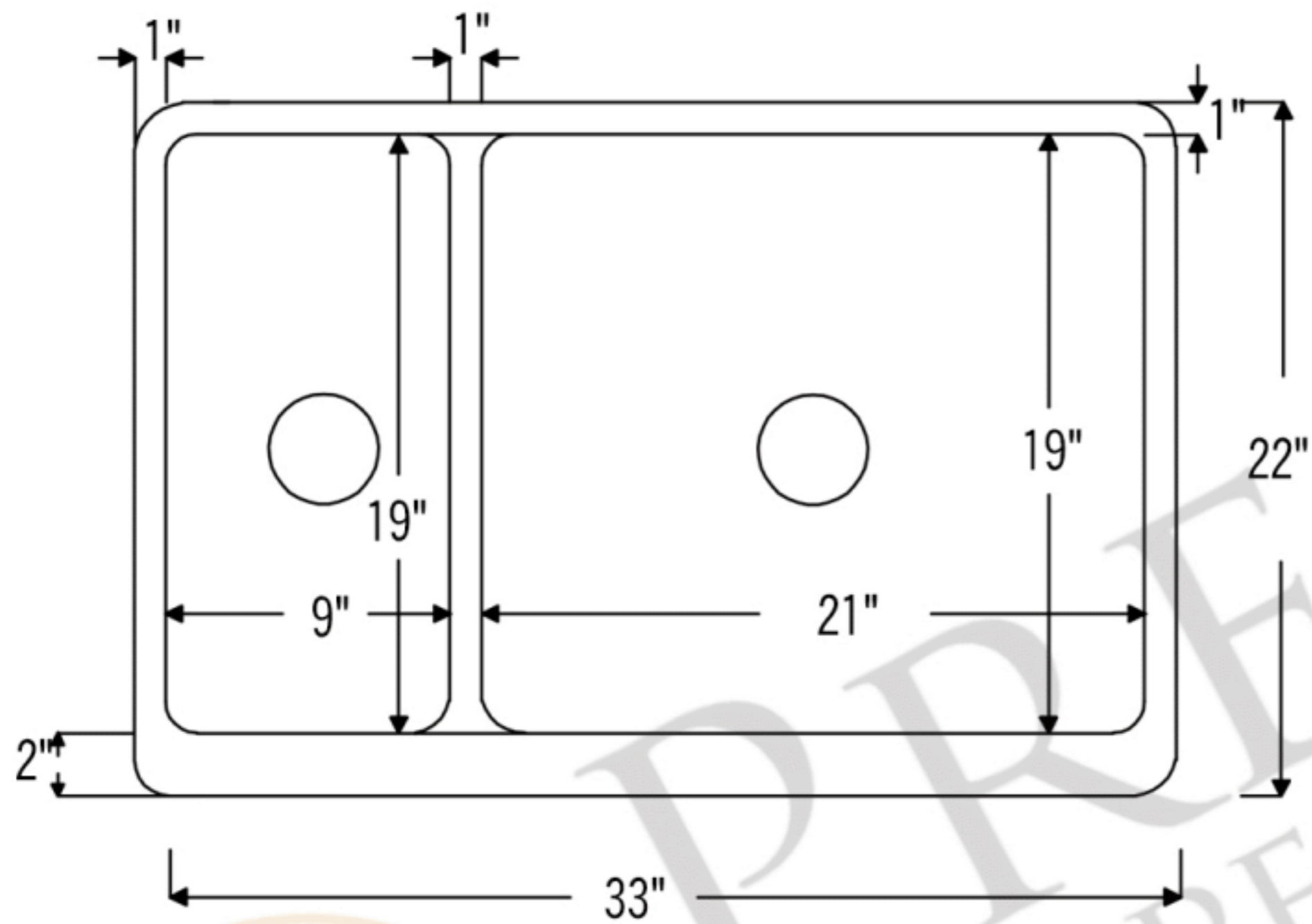

THIS PRODUCT IS HAND CRAFTED, SMALL VARIANCES IN COLOR AND SIZE MAY OCCUR.
DO NOT MAKE ANY INSTALLATION CUTS UNTIL YOU RECEIVE YOUR ITEM(S).