











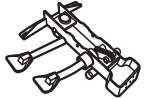

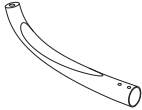
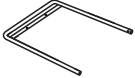
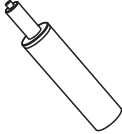
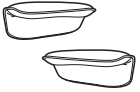
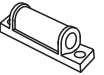

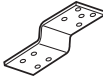



# Office Chair

User Manual

## PACKING LIST

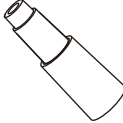
<b>A×1</b> 	<b>B×1</b> 	<b>Z×1</b> 	<b>U×1</b> 	<b>C×1</b> 
<b>D×5</b> 	<b>P×1</b> 	<b>F×1</b> 	<b>GA×2</b> 	<b>Q×2</b> 
<b>GB×2</b> 	<b>H×5</b> 	<b>N×1</b> 	<b>M×1</b> 	<b>R×1</b> 
<b>S×1</b>  5x10mm	<b>K×4</b>  6x20mm	<b>Y×8</b>  6x25mm	<b>L×10</b>  6x14mm	<b>E×4</b>  8x25mm
<b>W×6</b>  6x30mm	<b>J×6</b>  6x25mm	<b>X×1</b> 		

## INSTALLATION

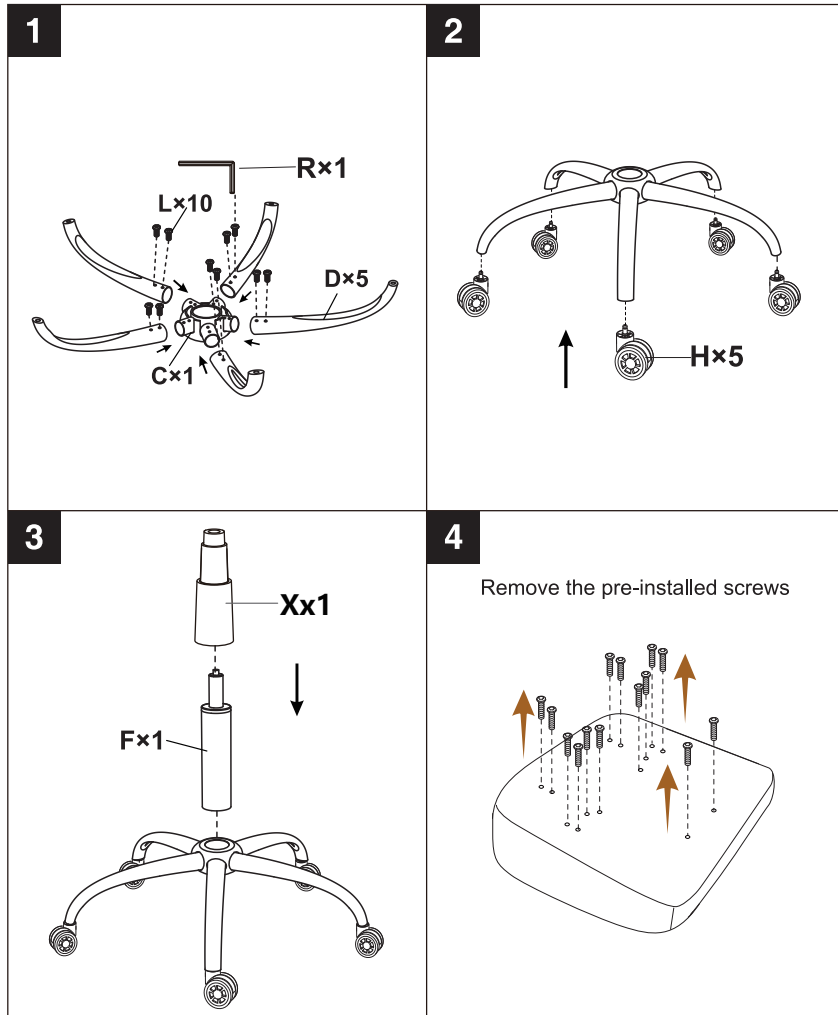

**Note:** All screws have been pre-assembled to the accessories. Please remove them from the accessories before assembling.

## INSTALLATION

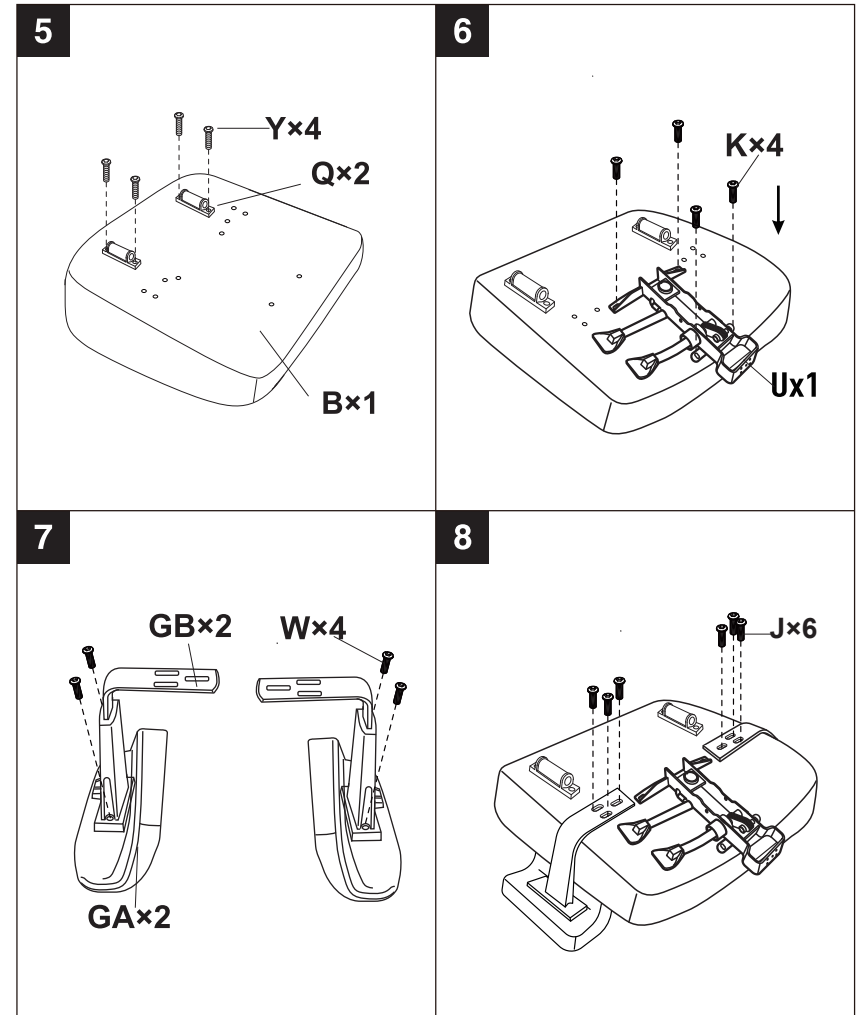

**Note:** All screws have been pre-assembled to the accessories. Please remove them from the accessories before assembling.

## INSTALLATION

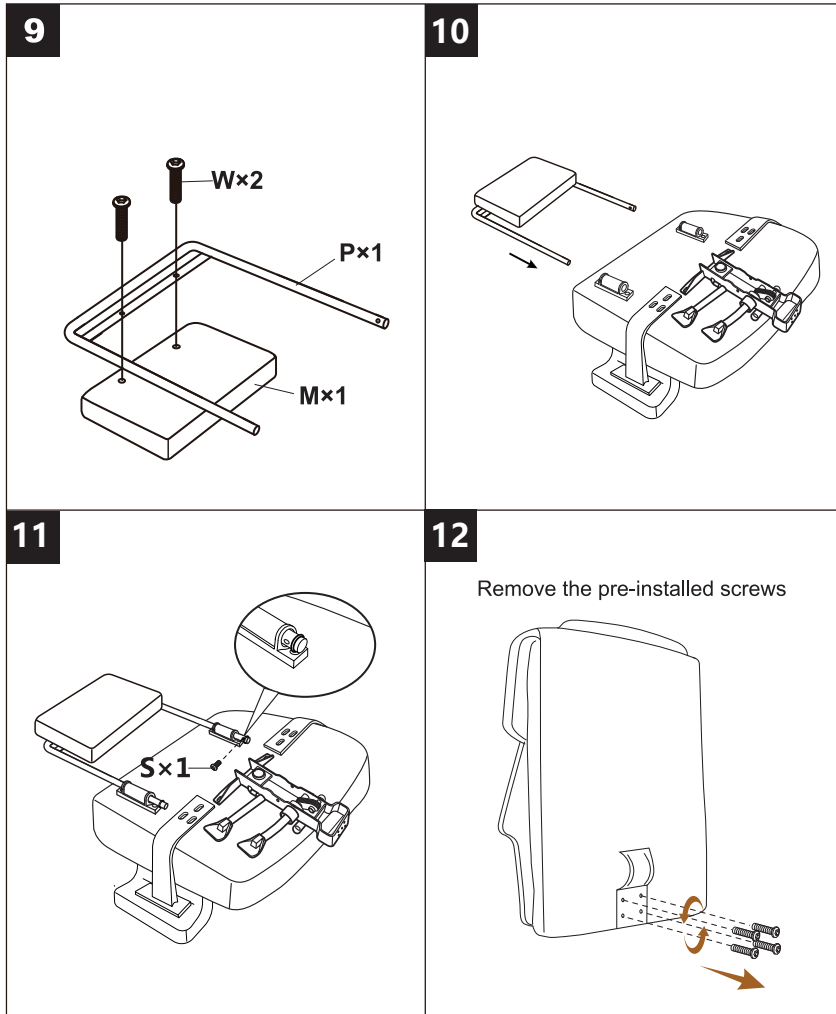

**Note:** All screws have been pre-assembled to the accessories. Please remove them from the accessories before assembling.

## INSTALLATION

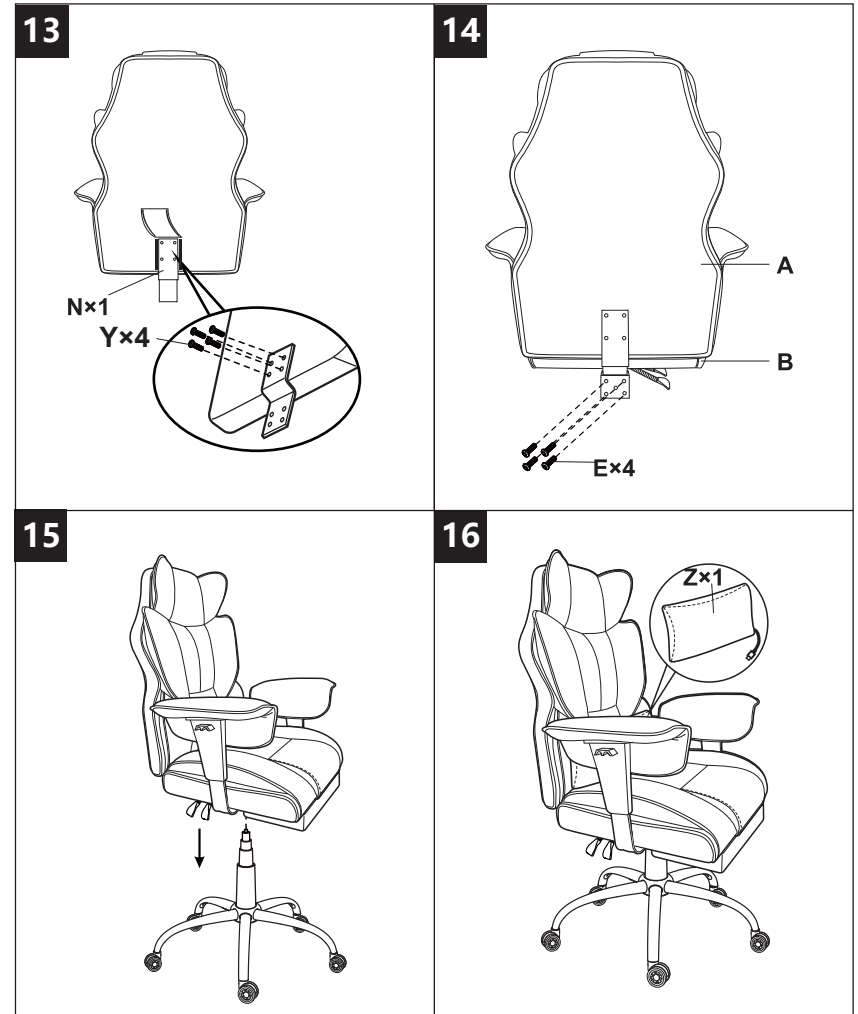

## TROUBLESHOOTING

Fault conditions	Possible causes	Exclusion method
The product is shaking and unstable	<ol style="list-style-type: none"><li>1. Wrong screw installation</li><li>2. The screw is broken</li><li>3. Check that the screws are not tightened in place</li></ol>	<ol style="list-style-type: none"><li>1. According to the instruction manual, install the correct screw in the correct position</li><li>2. To replace, use the included spare screws</li><li>3. Tighten the loose screws</li></ol>

## MASSAGE FUNCTION



Please press to start the waist pillow massage function.

## Armrest up and down adjustment function

