

Assembly Instructions

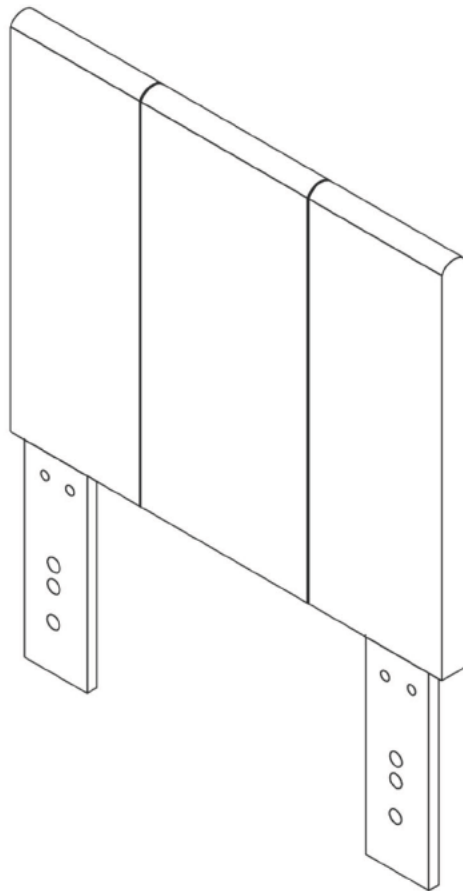

ASSEMBLY RATING

The Assembly Rating is a 5-point system that shows the degree of effort needed in assembling a specific product (with 1 being easy and 5 being difficult). For some products, two persons are recommended.

EASY  DIFFICULT

Tools Required for Assembly:

Allen Wrench



(Included)

Wrench



(Included)

Phillips Screwdriver



(Not Included)

ASSEMBLY & CARE ADVICE

FOR YOUR FURNITURE TO LAST, CORRECT ASSEMBLY AND PROPER MAINTENANCE ARE NECESSARY. PLEASE FOLLOW THE INFORMATION PROVIDED BELOW TO FULLY ENJOY YOUR FURNITURE.

BASIC ASSEMBLY TECHNIQUES



1 When lock or spring washer is used in an assembly, please make sure the lock or spring washer is placed between the larger flat washer and the head of the screw or bolt.



2 Position each part correctly and insert screws or bolts into their respective holes by hand tighten or using the proper hand tool. Only tighten when step is completed or when instructed to do so.



3 Use cardboard or carpet area when assembling furniture to prevent scratches. Make sure the furniture rests on a flat and level surface with each leg evenly touching the floor.



4 Some furniture comes with height adjustment knobs underneath each leg. To lower or to raise each leg, you need to turn clockwise or counterclockwise, respectively.



5 Make sure all parts are properly aligned, then use the appropriate hand tool to completely tighten the bolts or screws. Do not use power tools and do not overtighten.



6 Save the instructions and store the Allen wrench or any supplied tool for later maintenance. After two weeks, check and tighten any loose hardware and repeat again every six months thereafter.

IT IS THE USER'S RESPONSIBILITY TO MAINTAIN THE FURNITURE. THE HARDWARE MAY LOOSEN OVER TIME AND MAY CAUSE THE FURNITURE TO BE WOBBLY AND UNABLE TO SUPPORT ITS INTENDED WEIGHT CAPACITY. THIS MAY LEAD TO COLLAPSE AND MAY CAUSE SERIOUS INJURY.



FAILURE TO FOLLOW THE GUIDELINES ABOVE MAY RESULT IN INJURY AND/OR PROPERTY DAMAGE.

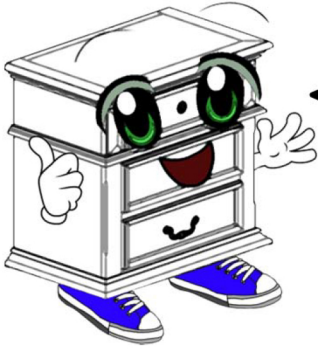

Before you begin, please read Page 2 of "Assembly and Care Advice".

And remember, do not tighten until each step is completed or instructed.

MD

Parts List

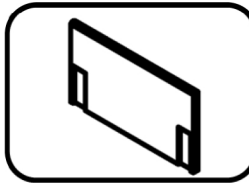

#1 x 1 pc
Headboard

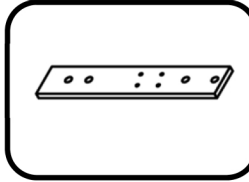

#2 x 2 pcs
Leg

Hardware List

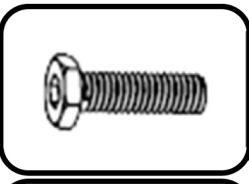

#A x 4 pcs
Bolt 5/16"x1-1/2"

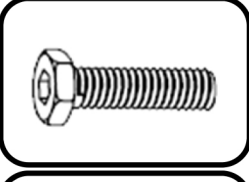

#B x 4 pcs
Bolt 5/16"x2-1/4"



#C x 12 pcs
Lock Washer

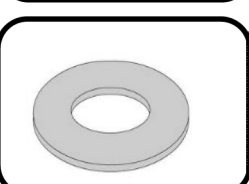

#D x 12 pcs
Flat Washer

Hardware List (Continued)

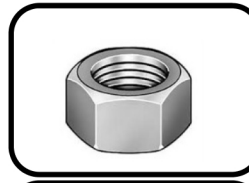

#E x 4 pcs
Hex Nut

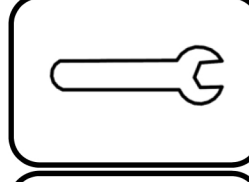

#F x 1 pc
Flat Wrench

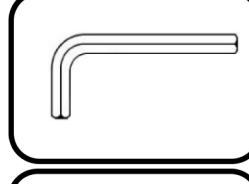

#G x 1 pc
Allen Wrench

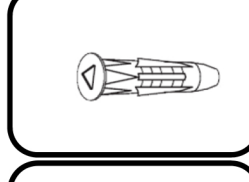

#H x 2 pcs
Anchor

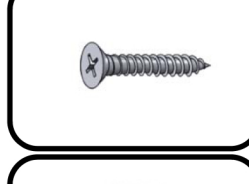

#I x 2 pcs
Screw

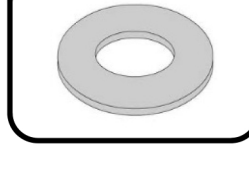

#J x 2 pcs
Flat Washer



Open Velcro to remove legs and hardware pack from behind the headboard (#1).

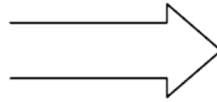
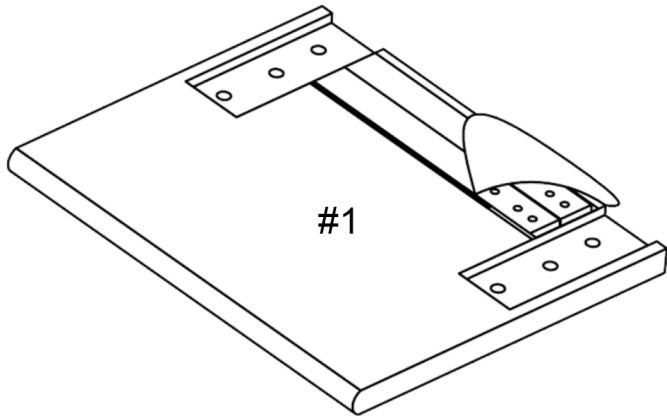

#A x 4 pcs
#C x 4 pcs
#D x 4 pcs

- I. Align the legs (#2) with the pre-drilled holes on the back of the headboard (#1).
- II. Prepare 4 bolt assemblies by inserting FIRST the lock washer (#C) onto the bolt (#A) and then the flat washer (#D) onto the SAME bolt (#A), in that order.
- III. Insert the bolt assemblies through the legs (#2) and secure those bolts using the Allen wrench (#G) to lock them in with the headboard (#1).

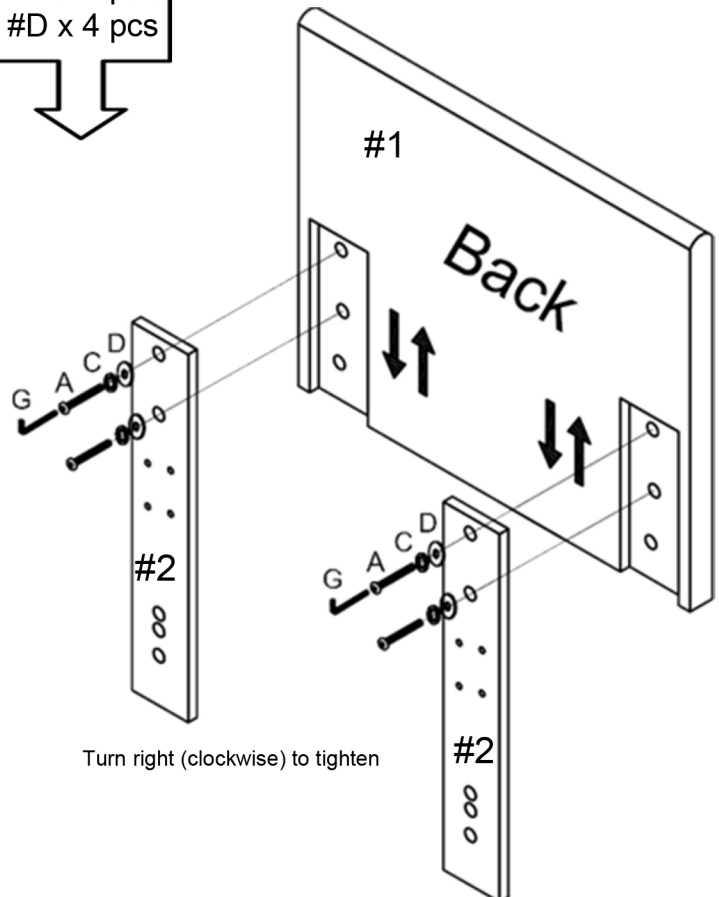



This is an optional step to assemble the headboard onto the bed frame (sold separately). Align the holes of the completed headboard with the holes of the bed frame. Insert the bolts and washers according to diagram below. Use the supplied tools to secure those parts.

- #B x 4 pcs
- #C x 8 pcs
- #D x 8 pcs
- #E x 4 pcs

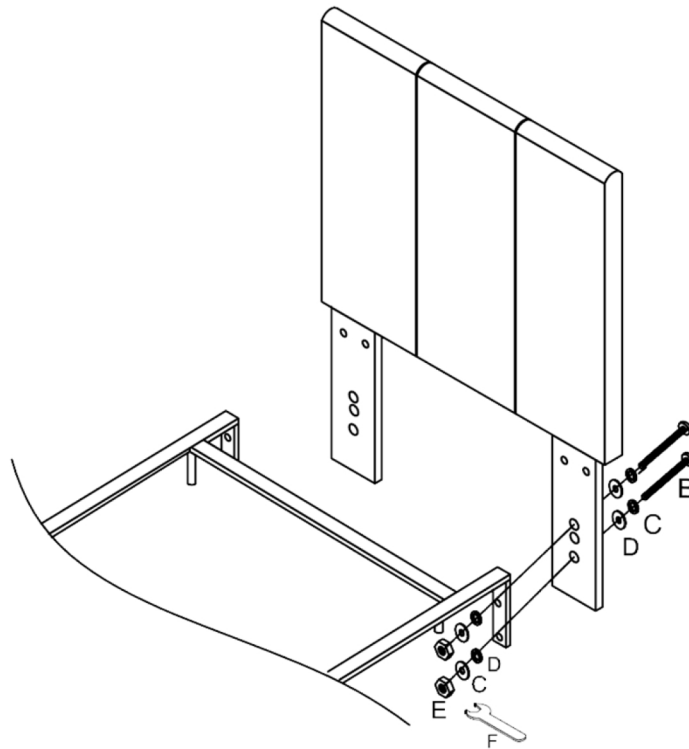

OPTIONAL WALL MOUNT

- I. Wall Mount (No Stud): Select a location where you want the headboard to be mounted. Mark on the wall the two locations where the wall anchors (#H) will be placed. Drill a hole for each anchor slightly smaller than the size of the screw. Push the anchor (#H) as far as it will go with your finger. Tap gently with a hammer until the wall anchor (#H) is flush with the wall surface. Align the headboard (#1) with the anchors (#H). Insert the screws (#I) with the flat washers (#J) into the legs (#2) and tighten those screws using a Phillips screwdriver to lock them down with the anchors (#H).
- II. Wall Mount to Stud: Repeat the process above using only the screws (#I) and flat washers (#J) but WITHOUT the anchors (#H).

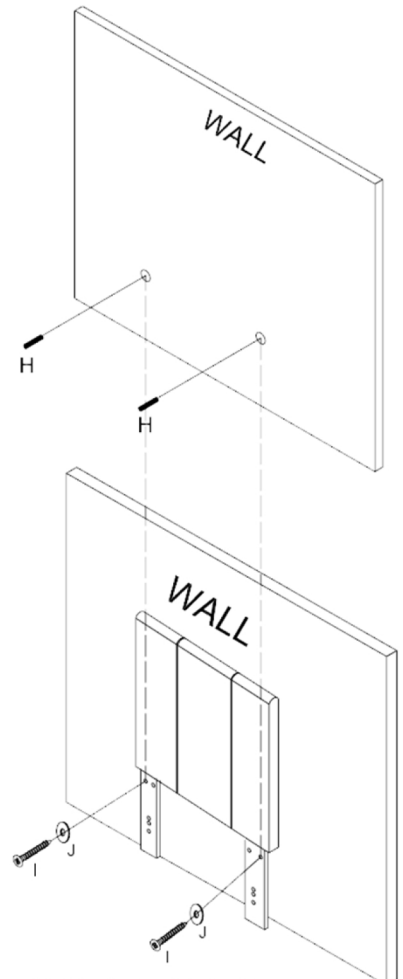

Turn right (clockwise) to tighten

ASSEMBLY IS COMPLETED