

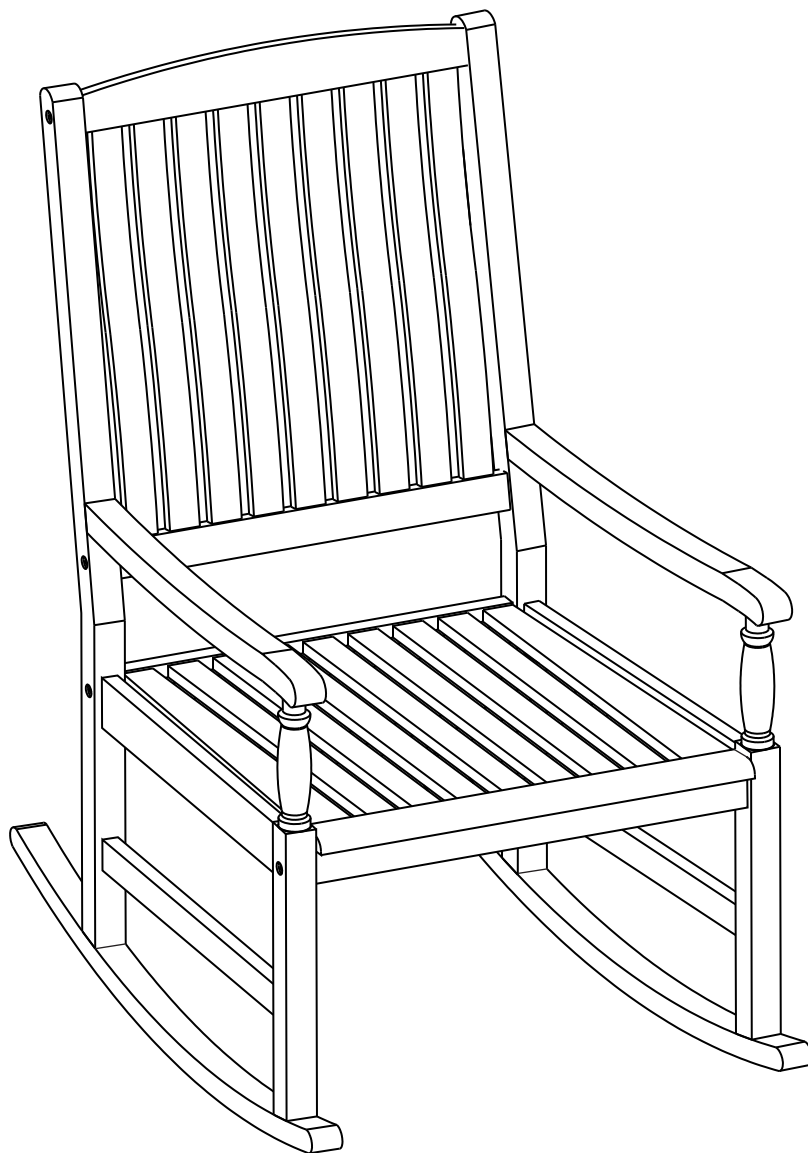

Assembly Instructions

Caution: You must read this before you process



Rocking Chair

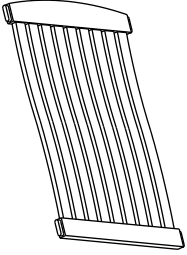
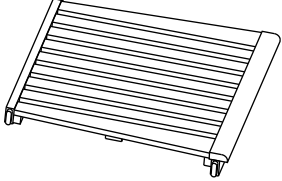
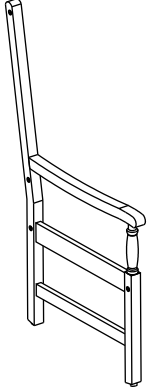
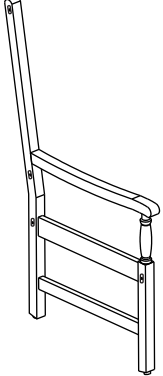

Parts List

Label	Picture	Description	QTY
A	 A rectangular panel with seven vertical slats, shown at an angle.	Backrest Panel	1
B	 A rectangular panel with seven horizontal slats, shown at an angle.	Seat Panel	1
C	 A wooden frame component for the left side of the chair, including the backrest support, seat support, and leg.	Left Leg Panel	1
D	 A wooden frame component for the right side of the chair, including the backrest support, seat support, and leg.	Right Leg Panel	1
E	 A curved wooden piece with two circular indentations, used as a rocker for the chair's base.	Rocker	2

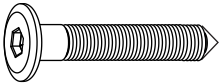
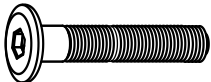
Hardware

Label	Picture	Description	QTY
①		Screw (M7x60mm)	9
②		Bolt (M6x65mm)	5
③		Cross Dowel (M6x13mm)	5
④		Allen Key	1

Assembly Preparation

Before Beginning Assembly:

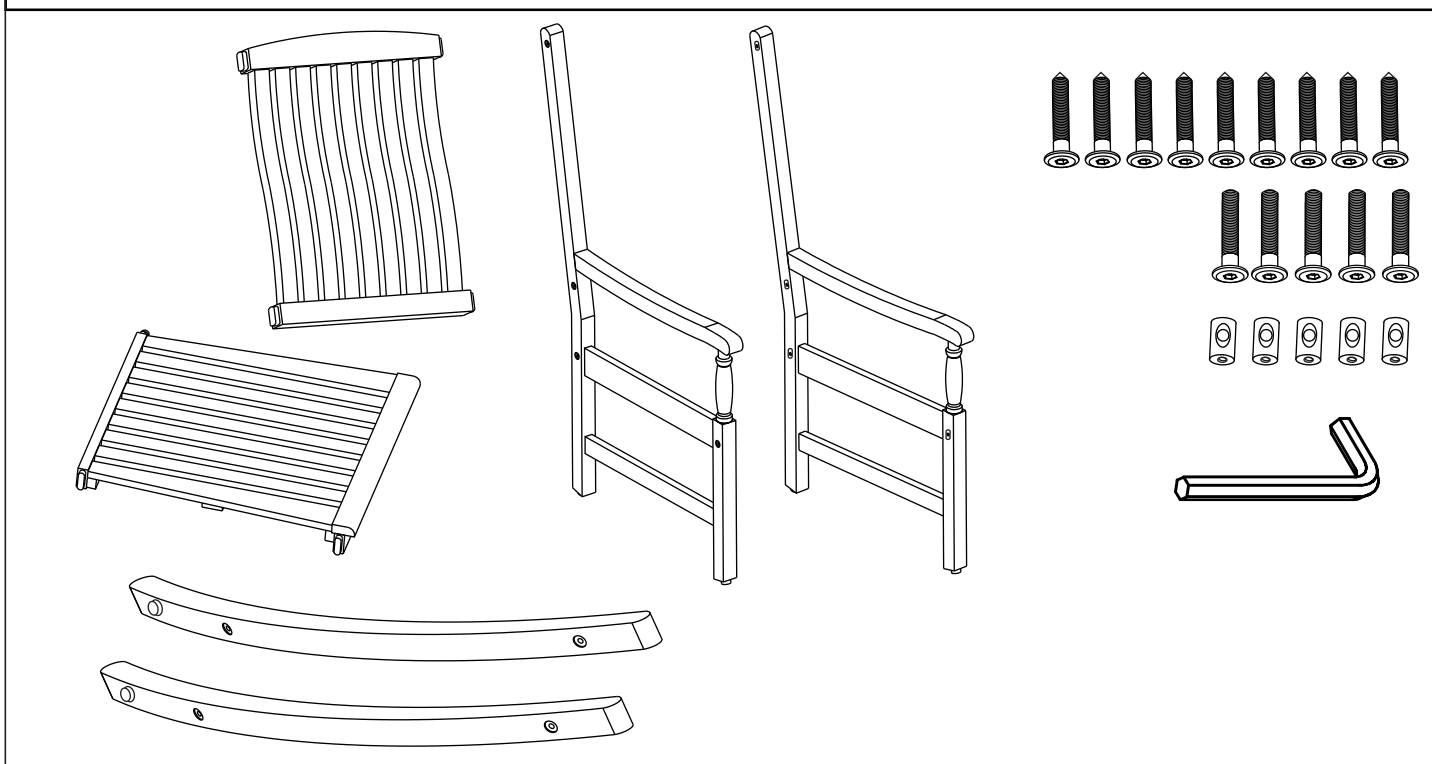

- Read instructions, cover to cover-



- Have 2 adults on hand for assembly-



- Do not assemble on flooring or carpet-



- Assemble on a clean non-marring surface (packing foam)-



- Save all packaging until finished-

Assembly Steps

OVERVIEW

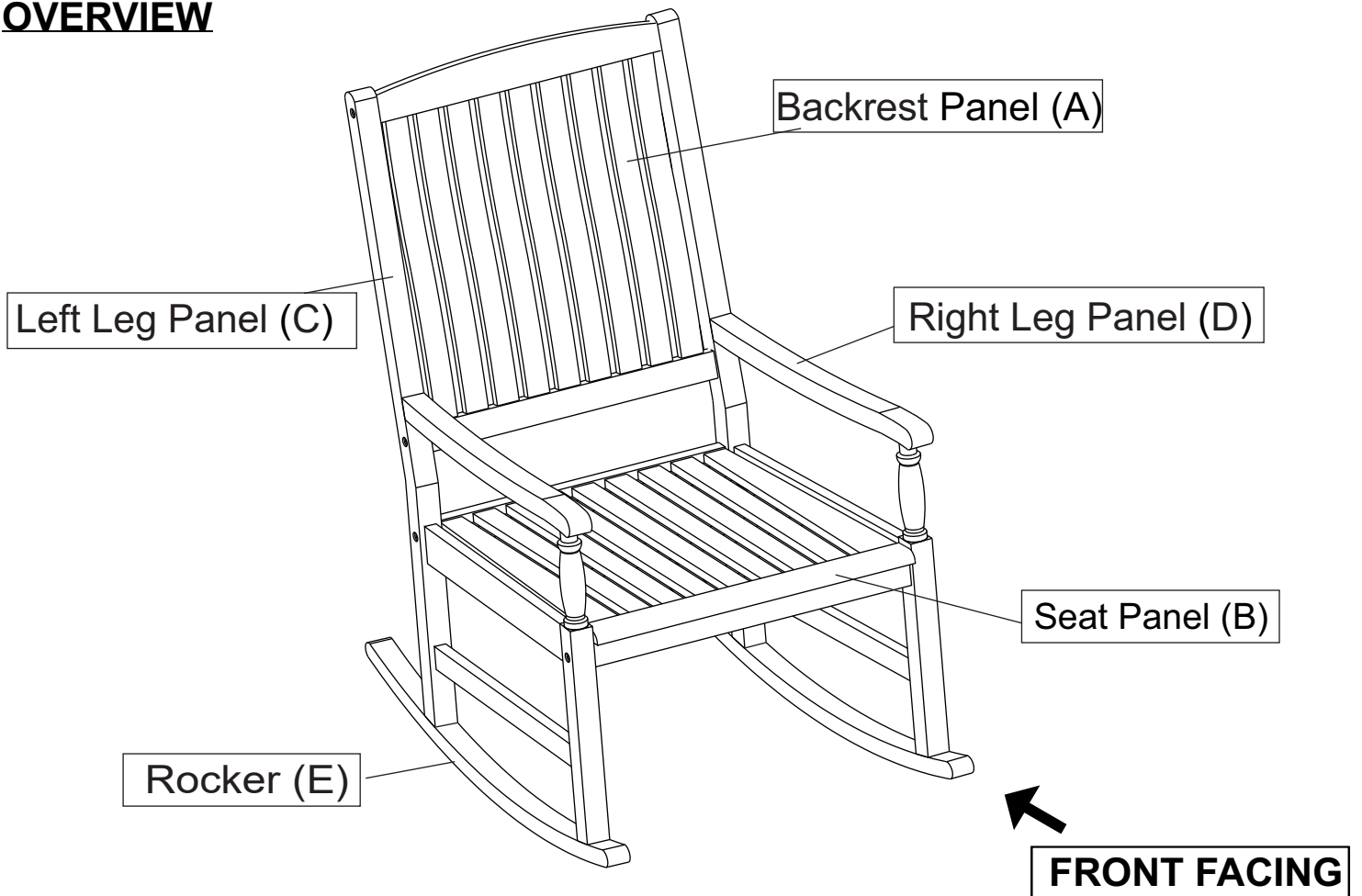

This Rocking Chair has multiple parts and may require up to 30 minutes to assemble. To give you an overview of the Rocking Chair parts, the above picture is to help you put the various parts into perspective. Please read through the instructions below to familiarise yourself with the parts and steps before assembly.

Step 1

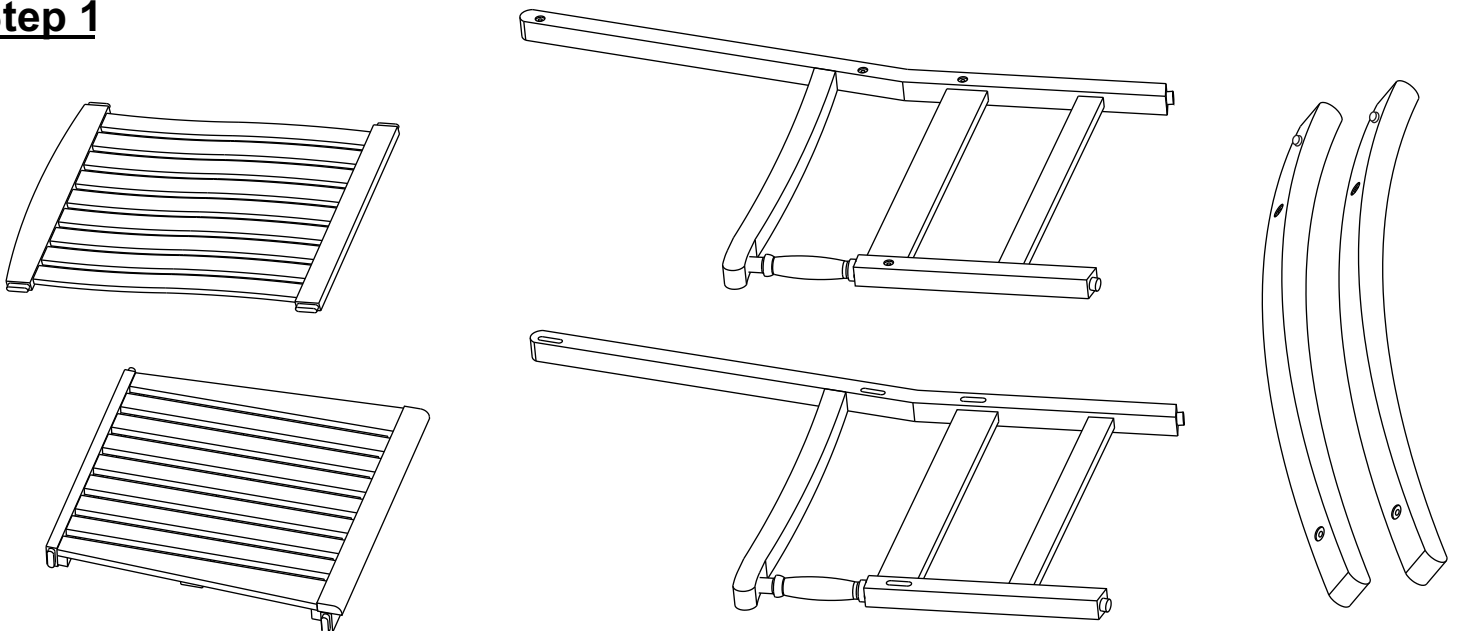

Unpack and place all parts on a clean, non-marring surface.

Step 2

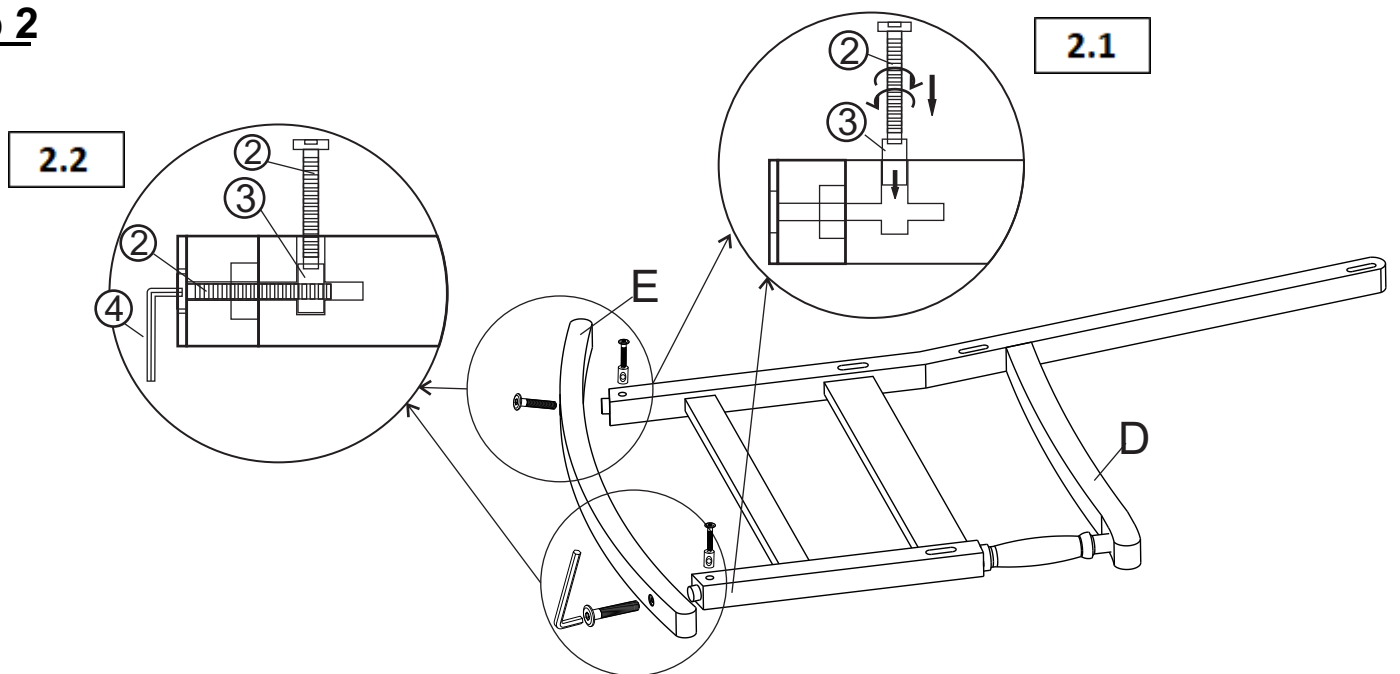

2.1) Insert Bolt (②) into Cross Dowel (③), then insert the Cross Dowel (③) into the housing on Right Leg Panel(D) as shown in above picture.

2.2) Put the tenon of Right Leg Panel(D) into the mortise of Rocker(E) then attach using Bolt (②), Cross Dowel (③) with Allen Key(④).

Note: Affix Bolt (②) into Cross Dowel (③) inside the Right Leg Panel (D) then remove Bolt (②) from the Cross Dowel (③) using Allen Key (④).

Repeat the same process with the Left Leg Panel(C) and Rocker(E).

Do not fully tighten Screws.

Caution: At the same time, please don't place your hands between the gaps to avoid injury.

Step 3

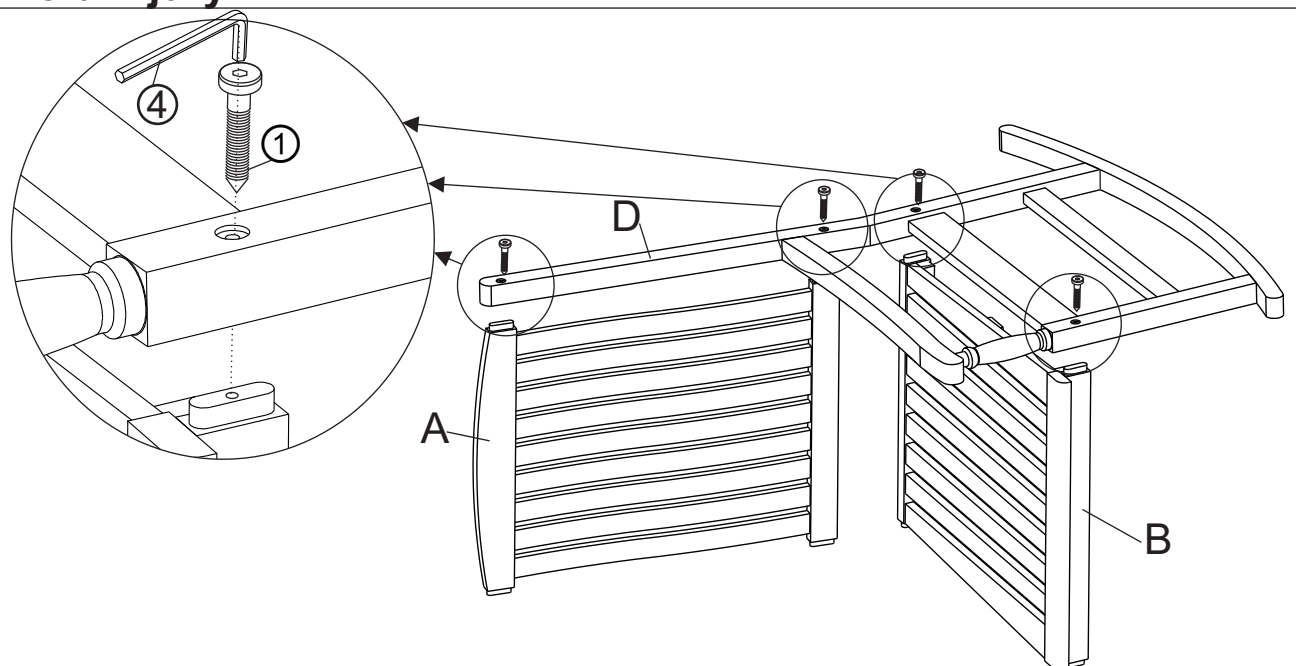

With assistance from your adult partners, put the tenon of Backrest Panel(A) and Seat Panel(B) into the mortise of Right Leg Panel(D) and attach using Screws (①) with Allen Key (④).

Do not fully tighten Screws.

Step 4

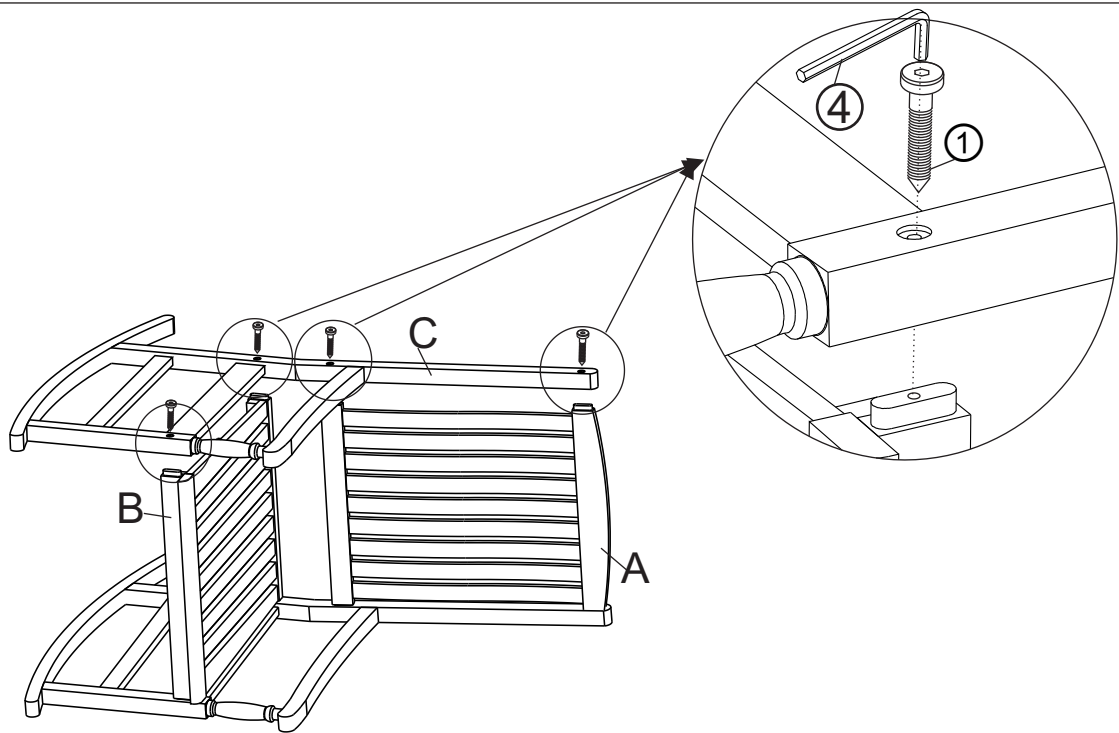

With assistance from your adult partners, turn the Chair into the other side. Repeat the same process in **Step 3** to attach Backrest Panel(A) and Seat Panel(B) to Left Leg Panel(C).
Do not fully tighten Screws.

Step 5

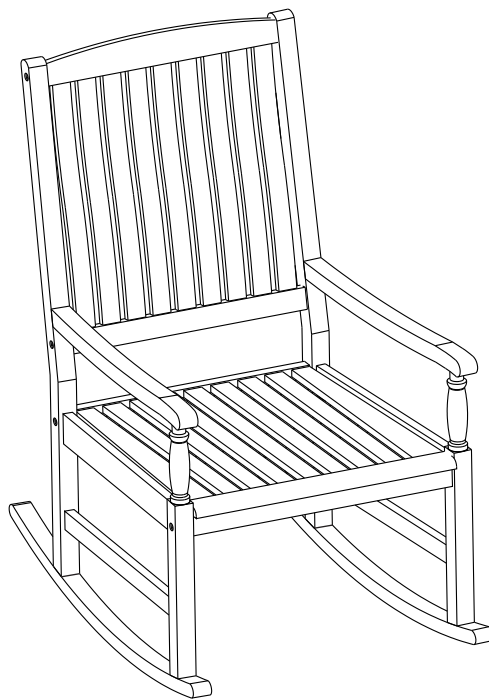

Inspect it and make sure all parts are adequately connected.

Gently and gracefully, sit onto the Chair.

This will help to align all the parts at all joint areas.

Then get off the Chair and proceed to tighten the Screws in a sequential manner.

When tightening the Screws tighten sequentially.

















DO NOT tighten any Screw fully and then move on towards the next one.



If there are still wobbles, loosen the Screws and execute this same process.

Your Rocking Chair is ready for use.

This Rocking Chair can only be used on a flat, level surface.

Care & Maintenance

-   ● Do not put hot items directly on furniture surface
-   ● Do not clean furniture with harsh cleansers or polish.
-   ● To obtain the longest lifespan of your outdoor products, minimizing exposure to direct sunlight is recommended.
-   ● Children should not climb or jump on the furniture.
-   ● Do not write on furniture without a padded barrier to protect the surface.
-   ● To obtain the longest lifespan of your outdoor products, avoid extended and lengthy exposure to rain, snow, and direct sunshine. Whenever possible cover the product and /or place under patio or awnings.
-   ● Not for commercial use. For residential use only .
-   ● Stains may be removed with mild soap solution and damp cloth.

-   ● Dust and pick-up spills using a clean, non-colored, lint-free cloth .