

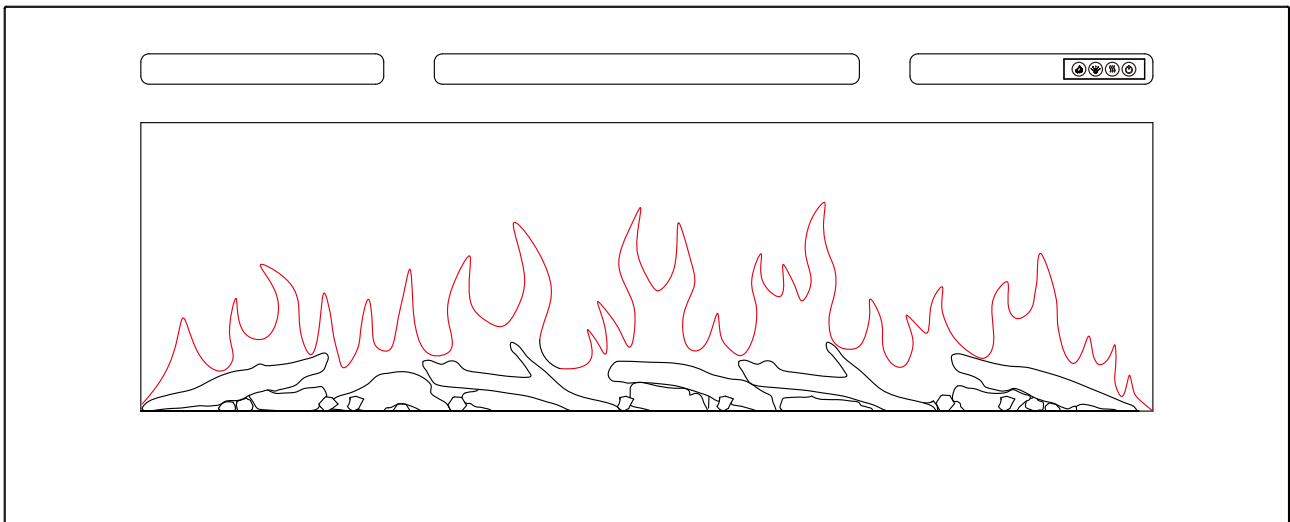



# In Wall Recessed Electric Fireplace

Model Number: (EF172B, EF173B, EF174B, EF175B, EF275A)

## OWNER'S MANUAL



|  |   |
|--|---|
|  <b>WARNING</b> | <p>Read and understand this entire owner's manual, including <b>all safety information</b>, before <b>plugging in</b> or <b>using</b> this product. Failure to do so could result in <b>fire, electric shock, or serious personal injury</b>.</p> |
|  <b>CAUTION</b> | <p>Keep this owner's manual for future reference. If you sell or give this product away, <b>make sure</b> this manual accompanies this product.</p>   |

**DO NOT RETURN!**

**Contact our customer service team for help first.**

**customerservice@puraflame.com**

**Call: 909-206-6608**



# CONTENTS

|                                       |    |
|---------------------------------------|----|
| 1. Important Safety Information ..... | 1  |
| 2. Technical Specifications .....     | 3  |
| 3. Before Installation .....          | 4  |
| 4. Installation Instruction.....      | 5  |
| 5. Operation Instruction.....         | 15 |
| 5a. Manual Control Panel.....         | 15 |
| 5b. Remote Control .....              | 16 |
| 6. Troubleshooting Guide.....         | 18 |
| 7. Schematic Diagram .....            | 19 |
| 8. Care and Maintenance .....         | 20 |
| 9. Limited Warranty .....             | 21 |



# 1. IMPORTANT SAFETY INFORMATION

When using electrical appliances, basic precautions should always be followed to reduce the risk of fire, electric shock, and injury to persons, including the following:

- **Read all instructions before using this appliance.**
- **Use this appliance only as described in this manual. Any other use not recommended by the manufacturer may cause fire, electric shock, or injury to persons.**
- **DO NOT use outdoors.**
- **NEVER** use this appliance in **bathrooms, laundry rooms**, or any other location where the appliance could fall into a **bathtub or pool, become damp, or come in contact with water.**
- **For residential use only. NOT for commercial use!** Any commercial or public use of this appliance **voids all warranties**, and could cause **injury**.
- This product is **not intended** to be a **primary heat source**. It is for **supplemental heat only**.
- **Do not** locate the appliance immediately **below** a fixed socket outlet.
- This appliance **must** be **grounded**.
- **DO NOT** operate any appliance with a **damaged cord or plug** or after the **appliance malfunctions**, has been **dropped** or **damaged in any manner**. Discard appliance, or return to authorized service facility for examination and/or repair.
- This appliance is **hot when in use**. To avoid burns, **DO NOT** let bare skin touch **hot** surfaces. Keep **combustible materials**, such as furniture, pillows, bedding, papers, clothes, and curtains at least **3 feet (0.9m)** from the **front of the appliance**.
- **Extreme caution** is necessary when any appliance is used by or near **children** or **invalids** and whenever the appliance is left **operating and unattended**.
- **DO NOT insert** or **allow foreign objects** to **enter any ventilation or exhaust opening**, as this may cause **electric shock** or **fire**, or **damage the appliance**.
- To prevent a possible fire, **DO NOT** block air intakes or exhaust in any manner. Doing so could cause a fire. **DO NOT** use on soft surfaces, like a bed, where openings may become blocked.
- As the appliance has **hot and arcing or sparking parts inside**. **DO NOT** use it in areas where **gasoline, paint, or flammable liquids** are used or stored.
- **AVOID FIRE!** Regularly inspect all air vents to make sure they are free from dust, lint, or other blockage. **Unplug the unit** and clean with a **vacuum ONLY**. **DO NOT** rinse or get wet.
- **DO NOT USE** this appliance with any **solid state speed control devices**.

- **Risk of electric shock! DO NOT OPEN!** No user-serviceable parts inside!
- **NEVER modify this appliance.** Doing so could result in personal injury or property damage. Modification of this fireplace **completely voids all warranties.**
- **NEVER** leave this appliance unattended. **To disconnect** appliance, **ALWAYS turn controls to “OFF”** then remove plug from outlet or turn off circuit when not in use.
- **ALWAYS** turn this appliance off before unplugging it from the outlet.
- **To prevent a possible fire, do not burn wood** or other materials **in this appliance.**
- **ALWAYS disconnect** this unit from the **power** supply **before** performing any assembly or cleaning, or before relocating the electric fireplace.
- **Always use** properly grounded, **fused** and polarized outlets.
- **Always use ground fault protection** where required by electrical code.
- **Avoid use** of an **extension cord** because an extension cord may overheat and cause a fire. However if you have to use an extension cord, the cord should be **No.14 AWG minimum size** and rated to not less than 1875watts.
- **NEVER** plug this appliance into an outlet that is **old, cracked,** or has any **loose wires or connections.** Plugging this appliance into a faulty outlet could result in **electric arcing** within the outlet that could cause the **outlet to overheat or catch fire.**
- **DO NOT** run **power cord** under carpeting. **DO NOT** cover power cord with throw rugs, runners, or similar coverings. **DO NOT** route power cord under furniture or appliances. Arrange power cord **away from traffic** area, and where it will not be tripped over.
- **ALWAYS** check your appliance cord and plug connections with **each use!**
  - A. **MAKE SURE** the plug fits tight in the outlet! Faulty wall outlet connections or loose plugs can cause the outlet to overheat.
  - B. **Appliances draw more current** than small appliances. **Overheating** may occur even if it has not occurred with the use of other appliances.
  - C. During use **check frequently** to see if the **plug outlet is HOT!** If the outlet or faceplate is **HOT, discontinue use immediately** and have a qualified electrician inspect and/or replace the faulty outlets.
- **SAVE THESE INSTRUCTIONS.**



**Safety Alert Key:**

- **WARNING!** Indicates a hazardous situation which, if not avoided could result in death or serious injury.
- **CAUTION!** Indicates a hazardous situation which, if not avoided, could result in minor or moderate injury.

## 2. TECHNICAL SPECIFICATIONS

### Electric Specifications

| Model                                | Volt | Watt(min/max) | Hz | BTU(max) | Amp  | Heating Area(max) |
|--------------------------------------|------|---------------|----|----------|------|-------------------|
| Alice 36"-68"<br>(EF275A/EF172-175B) | 120  | 750/1500      | 60 | 5120     | 12.5 | 400 square feet   |

### Product Dimensions

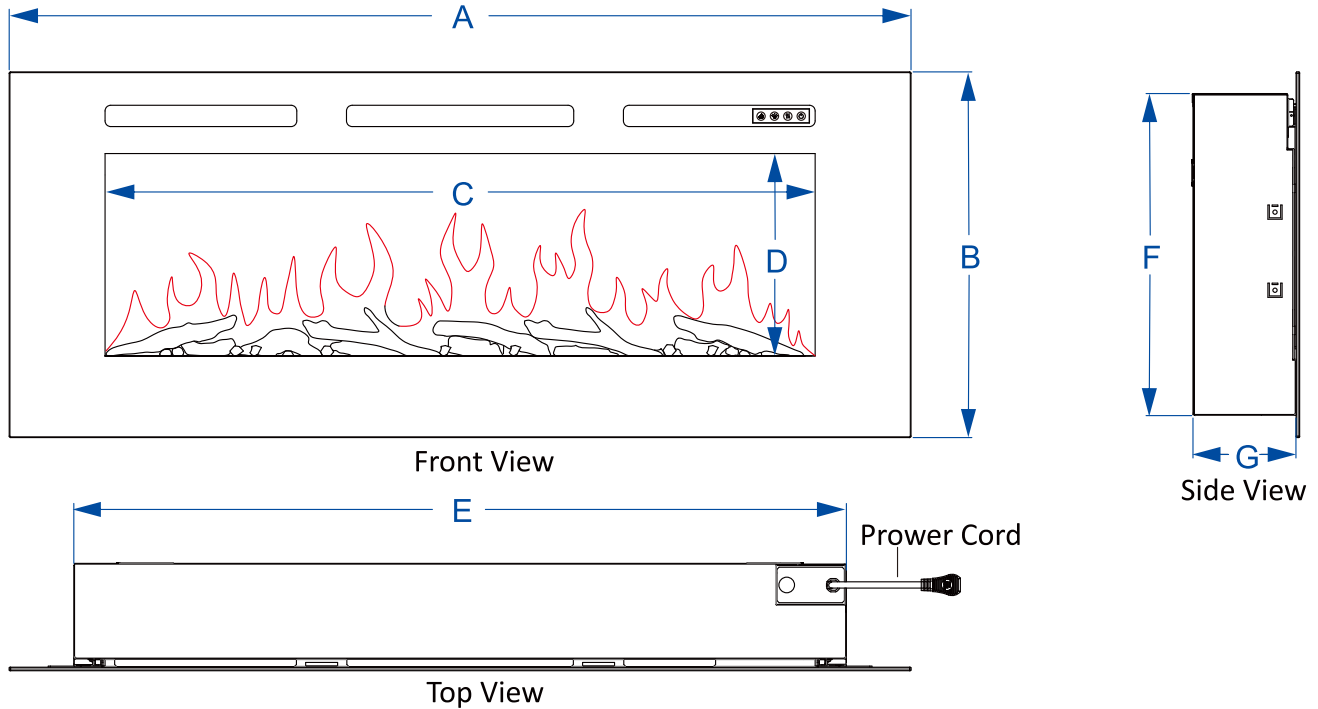

| Model                         | Unit | Overall Size |        | View Area |        | Firebox Dimension |         |         | N.W./lbs |
|-------------------------------|------|--------------|--------|-----------|--------|-------------------|---------|---------|----------|
|                               |      | A            | B      | C         | D      | E                 | F       | G       |          |
| Alice 36"<br>(EF275A)         | Inch | 36 3/8       | 20 1/4 | 31 1/2    | 11 1/4 | 35                | 18 1/32 | 5 11/16 | 47.75    |
|                               | mm   | 924          | 515    | 800       | 285    | 888               | 458     | 145     |          |
| Alice 40"<br>(EF172B)         | Inch | 40 9/16      | 20 1/4 | 31 1/2    | 11 1/4 | 35                | 18 1/32 | 5 11/16 | 47.75    |
|                               | mm   | 1030         | 515    | 800       | 285    | 888               | 458     | 145     |          |
| Alice 50"<br>(EF173B)         | Inch | 50           | 20 1/4 | 39 3/8    | 11 1/4 | 42 13/16          | 18 1/32 | 5 11/16 | 61.66    |
|                               | mm   | 1270         | 515    | 1000      | 285    | 1088              | 458     | 145     |          |
| Alice 50" white<br>(EF173B-W) | Inch | 50           | 20 1/4 | 39 3/8    | 11 1/4 | 42 13/16          | 18 1/32 | 5 11/16 | 61.66    |
|                               | mm   | 1270         | 515    | 1000      | 285    | 1088              | 458     | 145     |          |
| Alice 60"<br>(EF174B)         | Inch | 60 1/4       | 20 1/4 | 51 3/16   | 11 1/4 | 54 5/8            | 18 1/32 | 5 11/16 | 77.47    |
|                               | mm   | 1530         | 515    | 1300      | 285    | 1388              | 458     | 145     |          |
| Alice 68"<br>(EF175B)         | Inch | 68 1/8       | 20 1/4 | 59 1/16   | 11 1/4 | 62 1/2            | 18 1/32 | 5 11/16 | 87.66    |
|                               | mm   | 1730         | 515    | 1500      | 285    | 1588              | 458     | 145     |          |

**Note: Installation dimensions please see Page 7.**

### 3. BEFORE INSTALLATION

**WARNING! DO NOT use this Electric Fireplace if any part has been under water.** Immediately call a qualified service technician to inspect and to replace any part of the electrical system if necessary. Keep plastic wrapping away from children.

**If the unit needs to be returned, please make sure all the spare parts are packed inside, and packing the same as the original packing.**



#### Spare Parts Checking



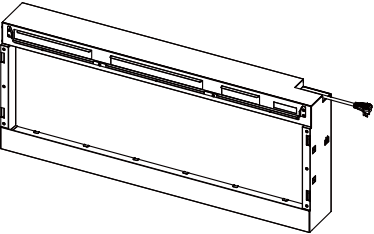
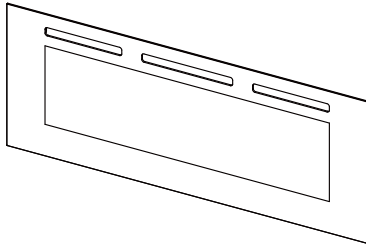

- Open the packaging carefully and remove the polystyrene. Keep the packaging (carton, polystyrene, etc.) for future transportation and/or storage.
- Check all the spare parts are fully received.
- Carefully check if any damages that may have for the spare parts.

**NOTE: Contact service team for help if any part missed or damaged.**

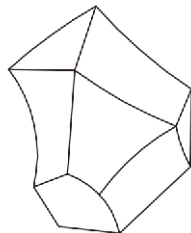
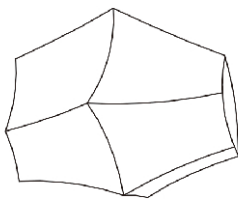
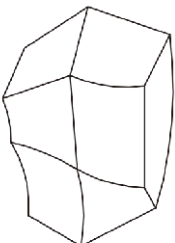
**E-mail: [customerservice@puraflame.com](mailto:customerservice@puraflame.com) or call 909-206-6608 during 9:00 to 17:00 from Monday to Friday.**

**WARNING:** This carton includes **GLASS! ALWAYS use extreme caution** when handling glass. Failure to do so could result in **personal injury or property damage.**

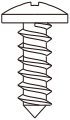
|   |   |  |
|---|---|--|
| <p><b>A.</b></p>  <p><b>Fireplace (1 pc)</b></p>                   | <p><b>B.</b></p>  <p><b>Glass Panel (1pc)</b></p>      | <p><b>C.</b></p>  <p><b>Logs</b><br/>(EF275A/EF172B 9 pcs, EF173B 11 pcs, EF174B 15 pcs, EF175B 17 pcs)</p> |
| <p><b>D&amp;E&amp;F are packed in one box</b></p>   |   |  |
| <p><b>D.</b></p>  <p><b>Small semi-painted Crystal (1 set)</b></p> | <p><b>E.</b></p>  <p><b>Larger Crystal (1 set)</b></p> | <p><b>F.</b></p>  <p><b>Small Clear Crystal (1 set)</b></p>   |
| <p><b>G to K are packed in one bag</b></p>  |   |  |

|  |  |   |
|--|--|---|
| <p><b>G.</b></p>  <p><b>Fireplace (1 pc)</b></p>      | <p><b>H.</b></p>  <p><b>AAA Battery (2 pcs)</b></p>   | <p><b>I.</b></p>  <p><b>ST 3*8 Screw (2 pcs)</b></p> |
| <p><b>J.</b></p>  <p><b>ST 4*40 Screw (4 pcs)</b></p> | <p><b>K.</b></p>  <p><b>Owner's Manual (1 pc)</b></p> |   |

**Function Testing**

**NOTE: Do not install the glass when testing.**

Plug it on, check the function as section 5a. Manual Control Panel and 5b. Remote Controls. **Should any defects found, please contact service team for help. E-mail us at [customerservice@puraflame.com](mailto:customerservice@puraflame.com) or call 909-206-6608 during 9:00 to 17:00 from Monday to Friday.**

**4. INSTALLATION INSTRUCTIONS**

**Tools Required**

A phillips screwdriver, a small flat head screwdriver, a plier will be needed.

**Locating the Appliance**

Your new electric fireplace may be installed virtually anywhere in your home. However, when choosing a location, ensure that the general instructions for safety are followed.

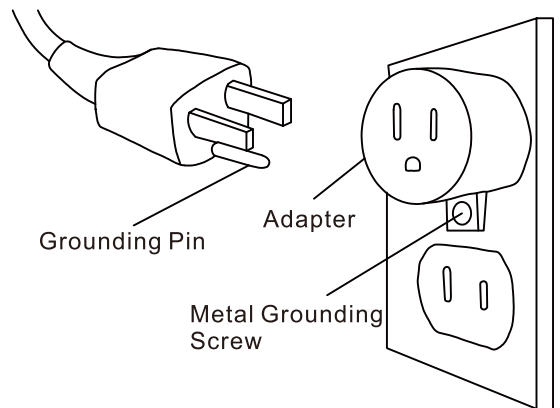

- For best results, install out of direct sunlight, water or very damp air.
- Power supply service must be installed within proximity of electric fireplace prior to finishing avoiding reconstruction.
- Try to avoid any conditions that may cause the fireplace to vibrate, which would result in the automatically turning on or off of the fireplace itself.
- Due to many different finish materials use on walls, it is highly recommended that you consult your local builder before you install this fireplace in the wall.

**Minimum Clearance to Combustibles**

- Sides..... 0 inch
- Floor.....0 inch
- Back..... 0 inch
- Top (Mantel or TV).....8 inch min
- Front..... 36 inch

**WARNING! Risk of Fire!**

Keep electrical cords, drapery, furnishings or other combustibles at least 3ft. (0.9 m) from the front of the electric fireplace.



**Electrical Supply Circuit Requirements**

Plan the location of the appliance so that it will have adequate electric power. A 15 AMP, 120V/60Hz circuit is required. Additional appliances on the same circuit as this appliance may exceed the current rating of that circuit. A dedicated circuit is not required, but is preferred to prevent circuit breaker trips or fuse failure.

Prepare the outlet close to the right side of appliance. **Make sure** the outlet is in good condition and the plug must be plugged tightly in the outlet.

For hard wiring, please refer to page 12.

**Flush Mounted Installation - 2x6 Framing**

4.1 Build the framing by 2x6" stud as picture for Alice 50" as example, dimensions for all sizes are listed below. The appliance will be supported by the bottom framing. Make sure the bottom framing is solid and level. Leave some gap behind the right stud for electrical supply.

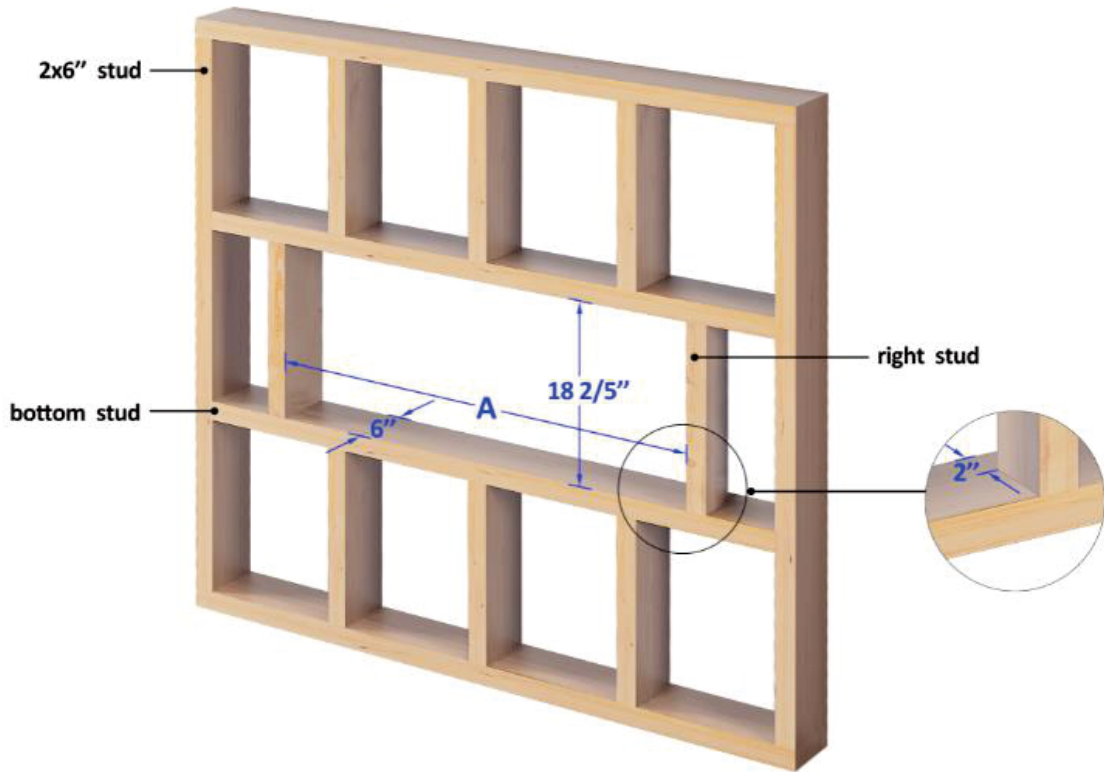

| Model | unit | Alice 36"<br>(EF275A) | Alice 40"<br>(EF172B) | Alice 50"<br>(EF173B) | Alice 50" white<br>(EF173B-W) | Alice 60"<br>(EF174B) | Alice 68"<br>(EF175B) |
|-------|------|-----------------------|-----------------------|-----------------------|-------------------------------|-----------------------|-----------------------|
| A     | Inch | 35 3/16               | 35 3/16               | 43 1/16               | 43 1/16                       | 54 7/8                | 62 3/4                |
|       | mm   | 894                   | 894                   | 1094                  | 1094                          | 1394                  | 1594                  |

If you want to stick ledger stone on plasterboard, add one more wood on each side .

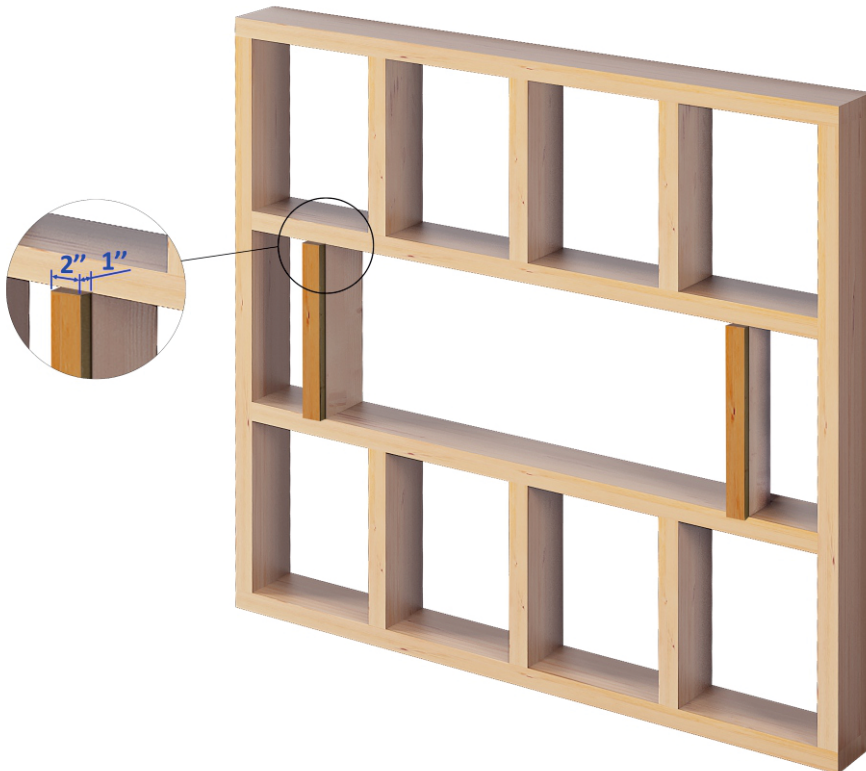

4.2 Prepare electrical supply.

4.3 Fix the plasterboard to edge of the framed opening.

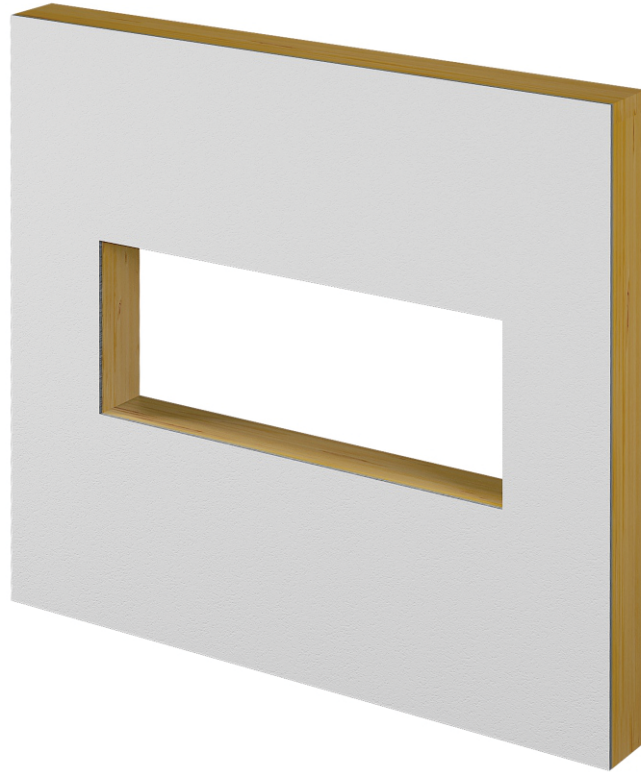

Paint or Wallpaper

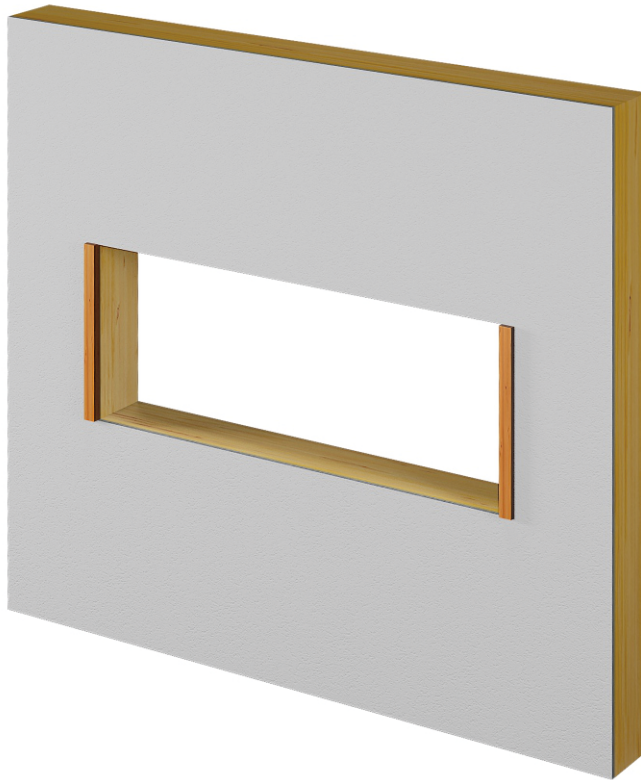

Ledger Stone

4.4 Finish the wall by paint, wallpaper or ledger stone.

4.5 Remove 3 screws on both left and right sides to take the side screen covers out, keep all of them in proper place.



4.6 Connect to electric service. Reference to Section Electrical connection.

4.7 Insert the firebox into the opening, adjust the position of unit and let it stick out the wall about 1/8", fix the fireplace on the side wood stud by the screws (ST4X40 4 pcs ) and fix the covers back with screws.

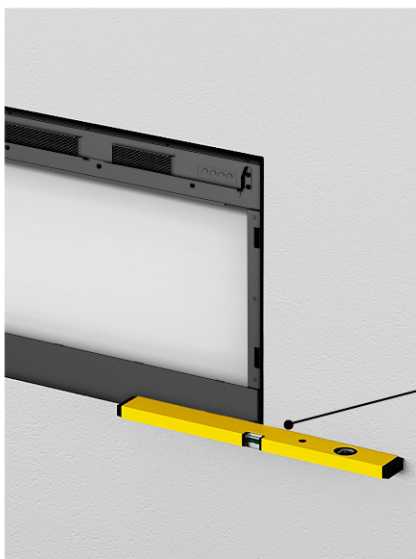

Paint or Wallpaper

Leave 1/8" gap  
between appliance  
and wall finishing



Ledger Stone

1/8" gap

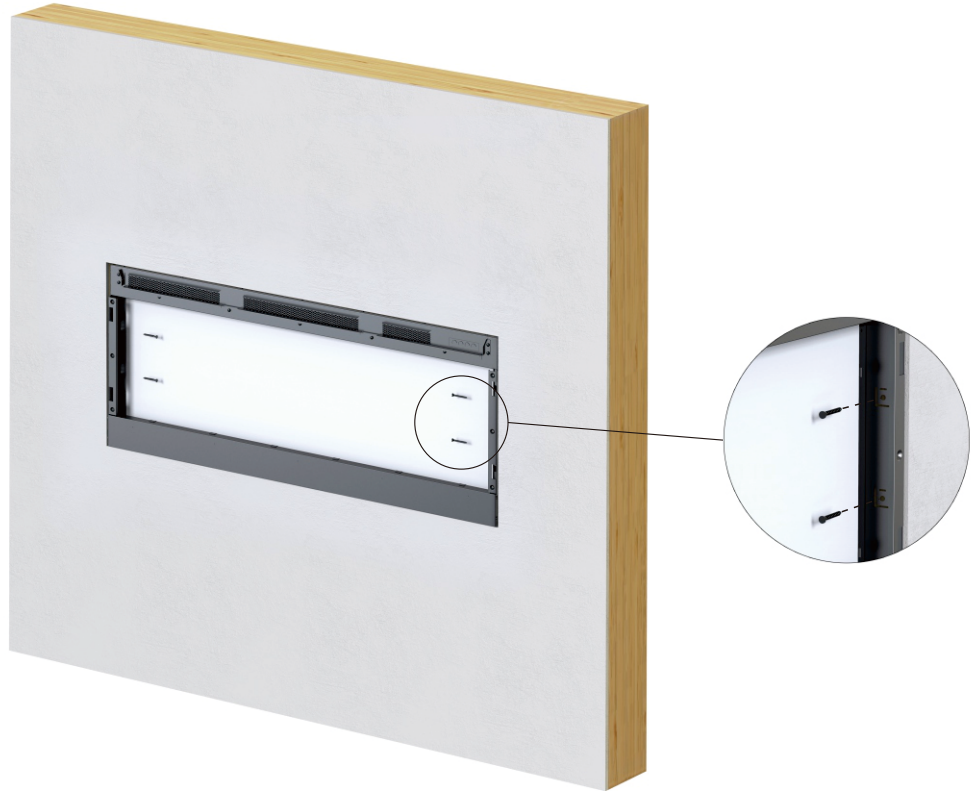

4.9 Set the fuel bed. Reference to Section **Fuel Bed Setting**.

4.10 Install the glass.



**CAUTION!** The next step requires installation of a **GLASS panel!** The manufacturer recommends that two adults install the glass panel. Always use **extreme caution** when handling **glass**. Failure to do so could result in **personal injury or property damage**.

**Note:** The glass panel should be placed in a safe place to avoid damaging before placing the fuel effect.

Carefully set 2 hooks on both sides of the front glass panel onto the holes of the firebox, put down the glass slowly. Fix the glass front by 2pcs screws (ST3x8) and complete the installation.

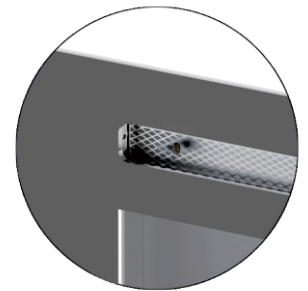
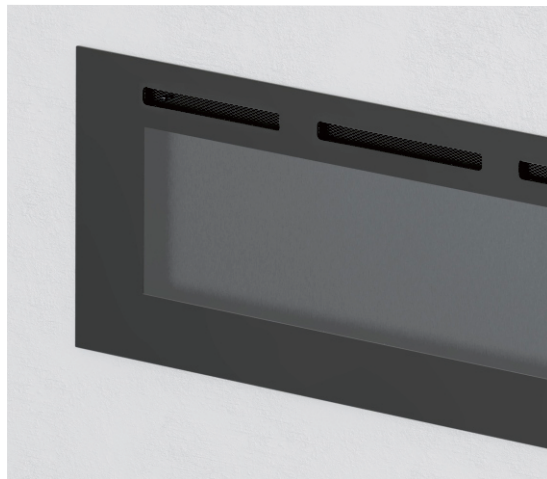

#### 4.11 finish the installation

### **Electrical Connection**

**WARNING:** Do not attempt to wire your own new outlets or circuits. To reduce the risk of fire, electric shock or injury to persons, the hard wiring must be supplied with a qualified electrician.

**WARNING:** Ensure that the circuit on which the fireplace is to be installed has the power cut off at the service panel until installation is complete.

The fireplace is packaged with a three prong plug installed for plug-in convenience. Hard wiring the fireplace is also an option for any installation.

- a. Plug in (the power cord is 6ft (1.8m) long and on the right of the fireplace, you may run the power cord out of the framed wall opening to an existing outlet or install an outlet on a nearby wall stud

within the wall). If the cord is not long enough to reach the outlet, a grounded extension cord minimum AWG No. 14 wiring and rated to a minimum of 1875 watts may be used.

b. Hard wire the fireplace (recommended). A qualified electrician may remove the cord connection, and wire the appliance directly to the house hold wiring. The appliance must be electrically connected and grounded in accordance with local codes.

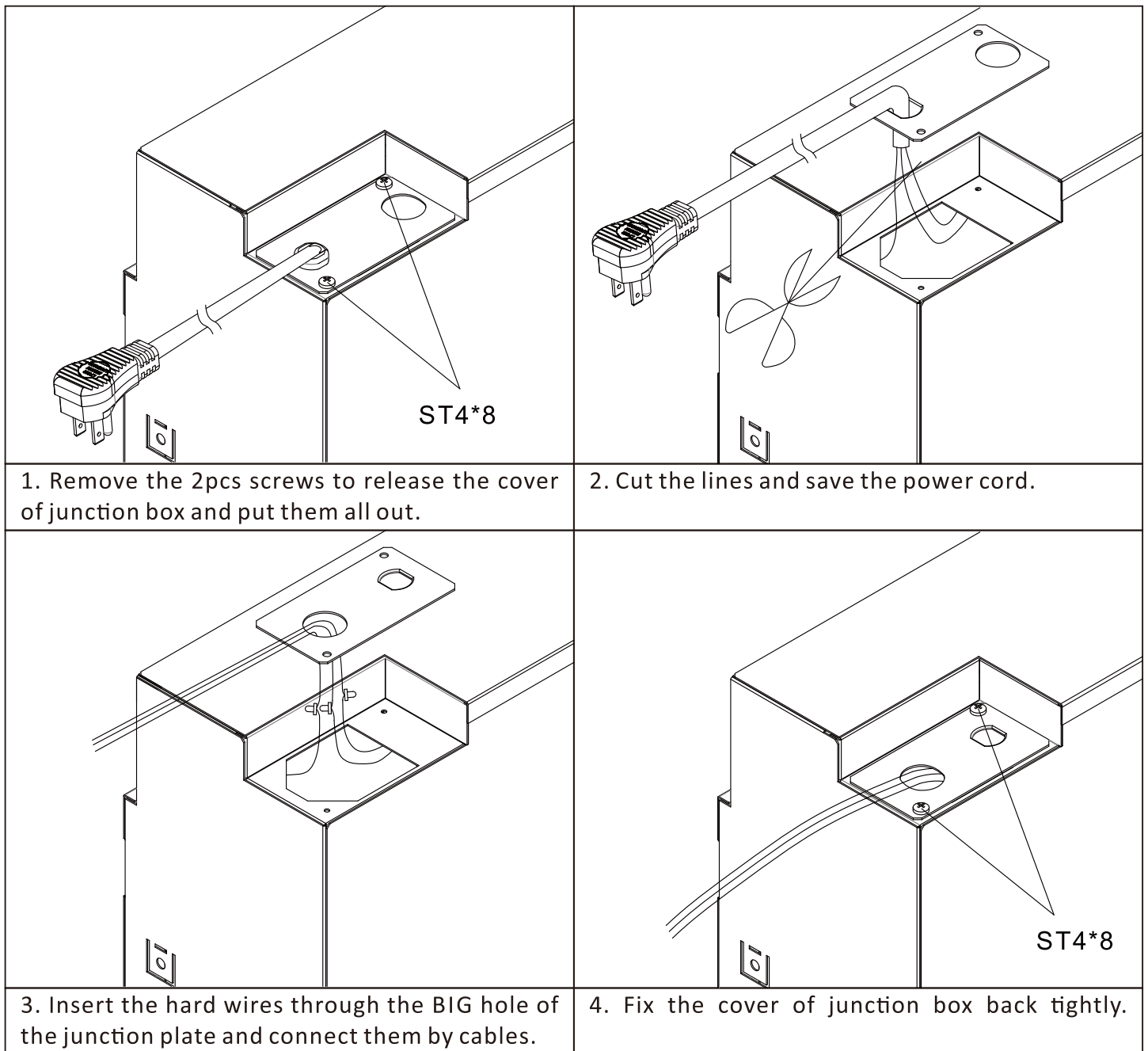

## **Fuel Bed Setting**

The appliance is supplied with 2 fuel effect options: a. Crystal Effect. b. Log Effect

### **a. Crystal Effect**

a1. Evenly spread the small clear crystals across the fuel bed. It is not necessary to use all of the effect supplied.

a2. Randomly space the large crystals throughout the fuel bed.

## b. Log Effect

**Logs must be positioned according to the following instructions to give the correct flame effect.**

The log layouts below cover all models. Please refer to Diagram and table on page 14 to identify the logs for specific models. The logs for the fuel bed are NOT individually labeled; the numbers are for reference information only.

b1. Place the small logs on the fuel bed as the log layout.



b2. Place the medium logs on the fuel bed as the log layout.



b3. Place the small semi-painted and clear (quantity: 2:1) crystals in between the log layout.





| Log No. | Medium |   |   |   |   |   |   |   | Small |   |   |  | total |
|---------|--------|---|---|---|---|---|---|---|-------|---|---|--|-------|
|         | A      | B | C | D | E | F | G | H | F     | G | H |  |       |
| EF275A  | 1      | 2 | - | 1 | 1 | 2 | 2 | - |       |   |   |  | 9     |
| EF172B  | 1      | 2 | - | 1 | 1 | 2 | 2 | - |       |   |   |  | 9     |
| EF173B  | 2      | 2 | - | 1 | 1 | 3 | 2 | - |       |   |   |  | 11    |
| EF174B  | 2      | 3 | 1 | 1 | 1 | 2 | 3 | 2 |       |   |   |  | 15    |
| EF175B  | 3      | 3 | 1 | 1 | 1 | 3 | 3 | 2 |       |   |   |  | 17    |

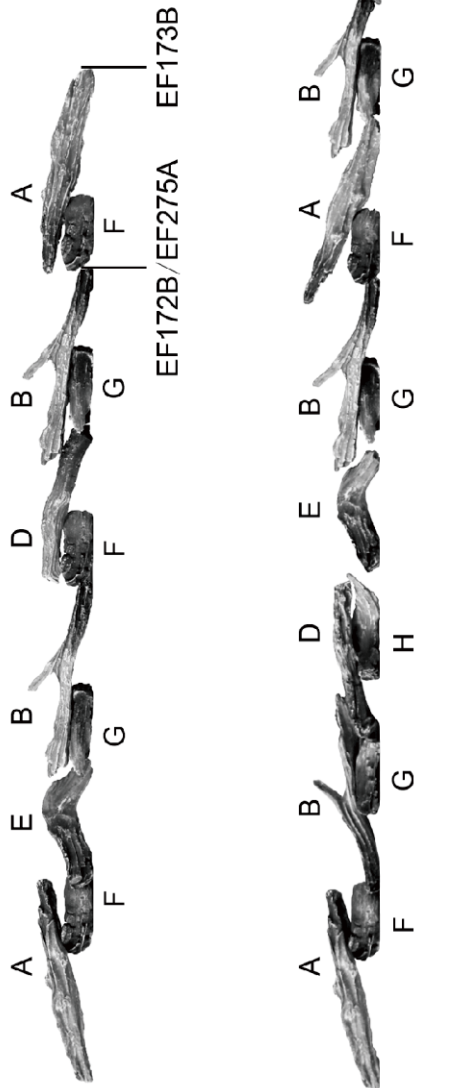

## 5. OPERATING INSTRUCTION



**WARNING!** Read and understand this entire owner's manual, including all safety information, before **plugging in** or **using** this product. Failure to do so could result in **electric shock, fire, serious injury, or death.**



**WARNING!** Do not operate the unit if it is damaged or has malfunctioned. If you suspect the unit is damaged, call a qualified service technician to inspect and replace any part of the electrical system if necessary.

The appliance can be operated by both remote control and manual button. Once the unit has been properly connected to a grounded electrical circuit, the unit can be turned ON by pressing the power button.

### 5a. Manual Control Panel

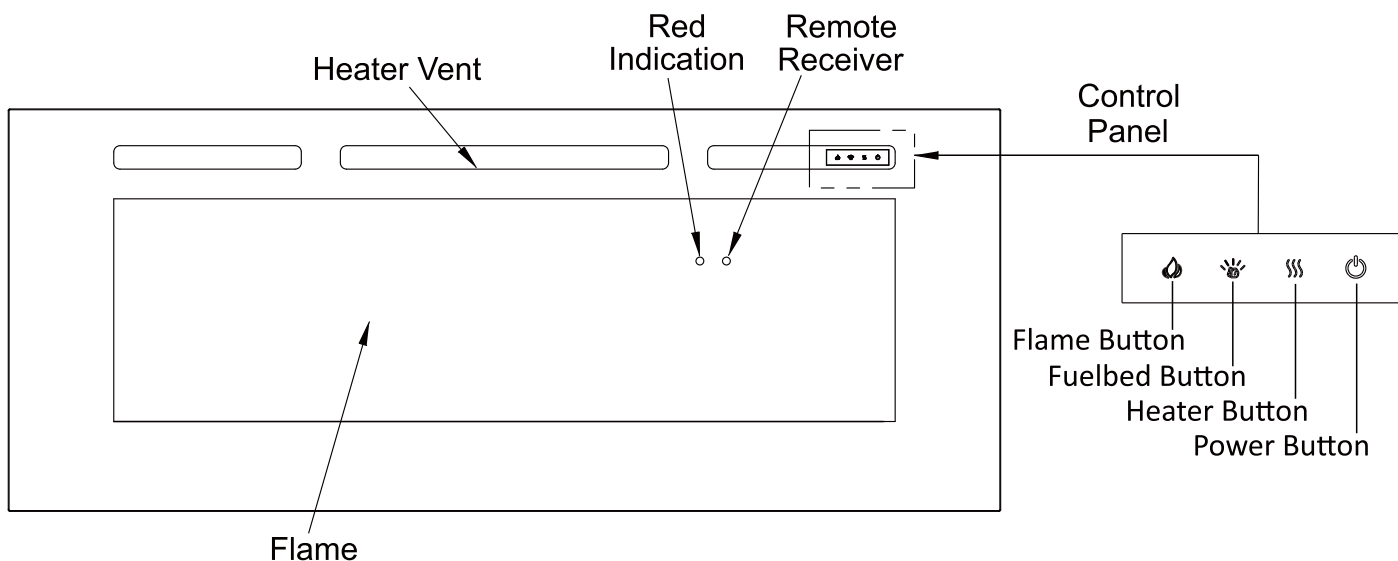

| ICON | TITLE    | FUNCTION   |
|------|----------|--|
|      | POWER    | The POWER button will turn the fireplace on, and enter standby mode. This will turn off all the functions at once but will hold the settings in memory except for the Heater function.   |
|      | FLAME    | Touch the FLAME button, the unit will cycle through four flame effects and Off setting.  |
|      | HEATER   | Touch the Heater button, the heater will cycle the heat setting: Low – High – Off. The fireplace will indicate: Low: (●○), High: (●●) . The indicate LED will disappear after 10 seconds.<br>The heater can be turned on without the flames and the fuel bed will light up slightly. |
|      | FUEL BED | Touch the Fuel Bed button, the unit will cycle through 13 colors, cycling and off setting  |

## NOTICE:

- Do not move the glass panel when the appliance is plugged in and operating. This will cause the control panel to no longer function.
- A harmless slight brief odor may occur during first use or not used for a long period of time.
- The heater can be turned on without the flames. The red LED indicators will turn on for 10s (one for low heating and two for high heating), and the 3<sup>rd</sup> fuel bed at 5% brightness will keep on.
- There is a brief delay between the heater command and the heating turning ON. When the appliance receives a heater ON command, the appliance blower will turn ON for 8 seconds before the heater turns ON. There is also an 8 second delay between heater off and blower shutdown.

### Temperature Limiting Control

This appliance is equipped with a Temperature Limiting Control. Should the appliance reach an unsafe temperature, the appliance will automatically turn OFF. To reset:

- Turn the ON/OFF switch on the CONTROL PANEL to OFF. Unplug the power cord from the outlet or switch off circuit. **Wait at least 15 minutes.**
- Inspect the fireplace to make sure no vents are blocked, or clogged with dust or lint. If they are, use a vacuum to clean the vent areas.
- With the POWER switch in the OFF position, plug the power cord back into the outlet.

If it switches off again, **UNPLUG THE APPLIANCE RIGHT AWAY!** Have the outlets, wiring, and breaker box inspected by a professional. Make necessary repairs before using the appliance.







## 5b. Remote Controls

### Remote Control Battery

- This remote control uses **two AAA batteries** (included).
- Instructions for battery installation are inside the Remote Control battery compartment.
- Battery must be recycled or disposed of properly. Check with your local authority for recycling advice in your area.

**NOTICE:** Aim the remote control at the **remote receiver**. Make sure you **hear a beep each time you press the button!** If not, the fireplace **will not respond** to the signal.



| ICON  | TITLE       | FUNCTION   |
|---|-------------|--|
|    | POWER       | The POWER button will turn the fireplace on, and enter standby mode. This will turn off all the functions at once but will hold the settings in memory except for the Heater function. The unit will be turned on at the same settings by pressing the power button again.                       |
|  | FLAME       | Press the FLAME button, the unit will cycle through four flame effects and Off setting.  |
|  | HEATER      | Press the HEATER button, the heater will cycle the heat setting: Low – High – Off. The heater indicator will turn on: Low: (●○), High: (●●). The indicator will disappear after 10 seconds. The heater can be turned on without the flames and the fuel bed will keep on in very low brightness. |
|  | TEMPERATURE | Press the TEMPERATURE button to adjust to set the room temperature from 61 °F - 82 °F (16 °C - 28 °C). Hold for 3 seconds and the LCD display from °C to °F. (Power button must be on).  |
|  | TIMER       | Press the TIMER button to set the timer from 0.5H to 9.0H.   |
|  | FUEL BED    | Press the FUEL BED button, the unit will cycle through 13 colors, cycling and off setting for fuel bed.  |

**NOTICE:**

- A harmless slight brief odor may occur during first use or not used for a long period of time.
- The blower will turn on 8s before the heater is on and turn off 8s after the heater is off.
- Do not move the glass panel when the appliance is plugged in and operating. This will cause the control panel to no longer function.

## TROUBLESHOOTING GUIDE

1. The unit does not work.  
Unplug it for 2 or more hours, replug it to see if there is a long beep, if not, the PCB board need to be replaced. Contact customer service team for help.
2. The blower works for about 5s then shut off.  
Press the temp button on the remote until there is no temp number showing on the remote display to see if the blower will work.
3. The unit turns on and off by itself.
  - 1) Confirm if the installation environment around may have vibration.
  - 2) If not, unplug and replug the glass to see if it will work, make sure the unit is off when you do this.
  - 3) If still not, the PCB and touch control panel needs to be replaced.
4. The flame does not flicker.  
The spindle might be stuck by the wires that falling off or the flame motor is stuck, please contact customer service team for a checking instruction manual to proceed.
5. One side of the flame disappeared or higher or weak or strange.  
If other functions such as the fuel bed and heating are working properly, the flame LED board might jump out from the fixers and need to be adjusted, if it does not work, the flame led boards need to be replaced.
6. The color of the fuel bed is not consistent.  
The fuel bed LED board needs to be replaced.
7. There is a noise only when the flame is on.  
The spindle touches the wires or panels around, please contact customer service team for a checking instruction manual.
8. There is a noise only when the heater is on.  
The fan touches the wires, please contact customer service team for a checking instruction manual.
9. The heater of my new product does not work.
  - 1) The blower works for about 5s then shuts off.  
Press the temp button on the remote until there is no temp number showing on the remote display to see if the blower will work. If not, check if the sensor is loosen, if yes, please kindly noted that there would be a 3 degree deviation between the temp the sensor feels and the room temp.
  - 2) There is no air blowing.  
Check if the connector on the PCB board that links to the fan is loosen, if not, the problem might be the PCB board.
  - 3) There is only cold air.  
The heating element might be broken. Please contact customer service team for help.

4) It blows a little heat and then shut off and never come back unless replug it.

The fan might be stuck or the heat motor is fall off. Confirm if there is something getting red inside the air outlet when turn the heater on, then contact customer service team for help.

10. The heater of my old product no longer works.

The fan or PCB board needs to be replaced. Please contact customer service team for help.

11. The glass is broken.

The glass is available on Amazon, please contact customer service team for a purchase link.

12. The remote does not work or there is nothing showing on the display.

The remote is available on Amazon, please contact customer service team for a purchase link.

13. There is a plastic burning smell when the heater is turned on for the first time.

It is normal and the smell will disappear after several minutes.

14. TV remote could change the color of the flame.

It is the signal interference, please contact customer service team for a new PCB board.

## SCHEMATIC DIAGRAM

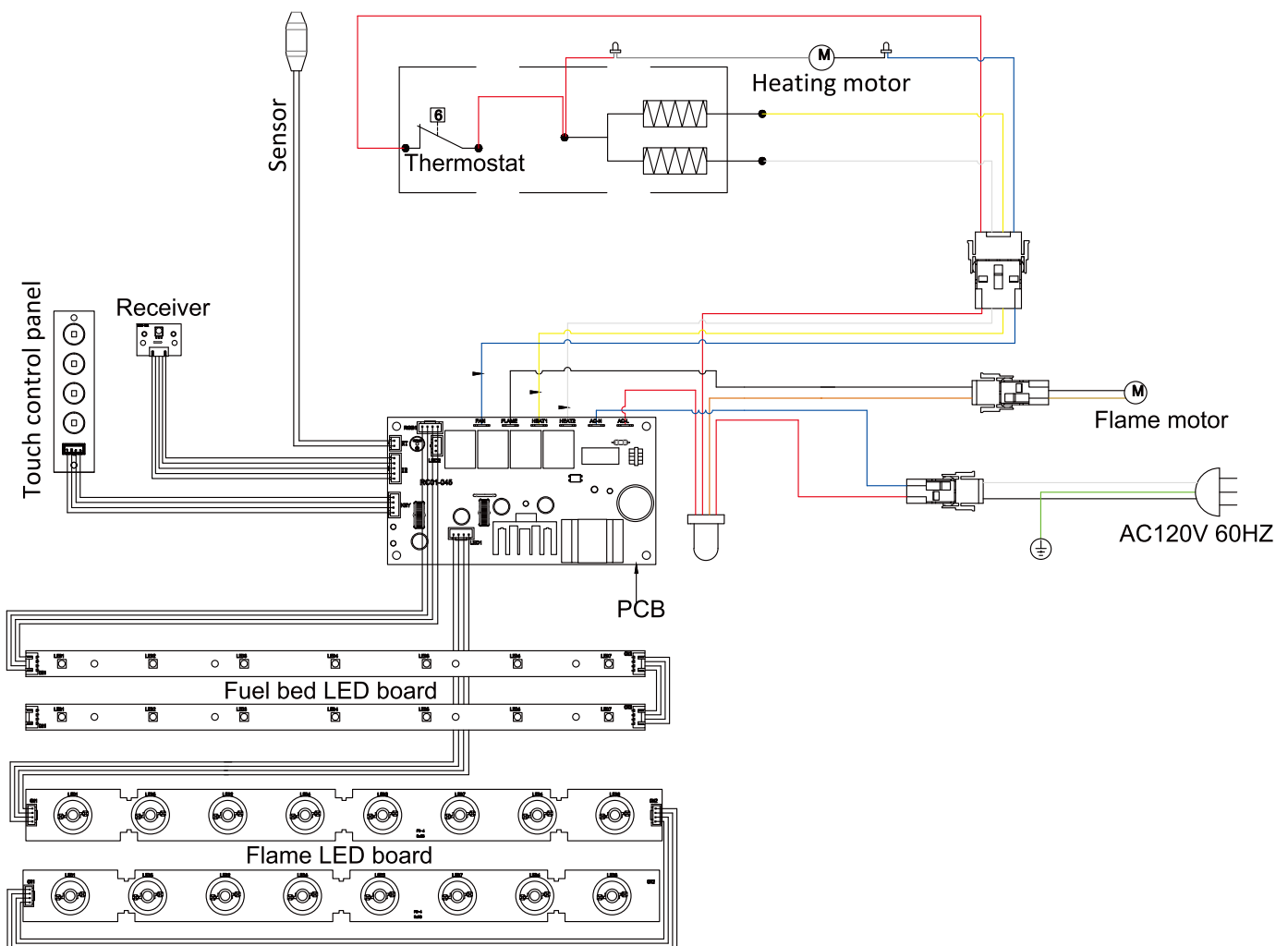

## CARE AND MAINTENANCE

- **ALWAYS** turn the appliance **OFF** and **unplug the power cord from the outlet** before cleaning, performing maintenance, or moving this fireplace. Failure to do so could result in **electric shock, fire, or personal injury**.
- **NEVER immerse in water or spray with water**. Doing so could result in **electric shock, fire, or personal injury**.
- **Risk of electric shock! DO NOT OPEN! No user-serviceable parts inside!**

### CLEANING

#### Metal:

- Buff using a soft cloth, slightly dampened with a citrus oil-based product.
- **DO NOT** use brass polish or household cleaners as these products will damage the metal trim.

#### Glass:

- Use a good quality glass cleaner and dry thoroughly with a paper towel or lint-free cloth.
- **NEVER** use abrasive cleansers, liquid sprays, or any cleaner that could scratch the surface.

#### Plastic:

- Wipe gently with a slightly damp cloth and a mild solution of dish soap and warm water.
- **NEVER** use abrasive cleansers, liquid sprays, or any cleaner that could scratch the surface.

#### Vents:

- Use a vacuum or duster to remove dust and dirt from the appliance and vent areas.
- Clean the exterior of the fireplace with a slightly damp cloth or duster.

### MAINTENANCE

#### Electrical and Moving Parts:

- The fan motors are lubricated at the factory and will not require lubrication.
- Electrical components are integrated in the fireplace and are not serviceable by the consumer.

#### Storage:

- Store appliance in a clean dry place when not in use.

#### Replacement parts:

- Use only replacement parts supplied by the manufacturer. Use of any other parts, or modifying the fireplace in any way, will void all warranties.
- No internal parts are replaceable or serviceable.

## LIMITED WARRANTY

This warrants to the original purchaser that this product is free from defects in material and workmanship as of the date of purchase and that it will, under normal use and proper care, remain so for one year from the date of purchase. Missing or initially defective parts will be replaced free of charge during the period of this limited warranty. If parts are unavailable, comparable replacement of refund will be given. **The original dated sales receipt is required for all warranty claims.** This warranty does not cover damage which has occurred during transport from the point of purchase to the consumer's home. This warranty does not cover glass, light bulbs, batteries, transportation, labor, or other issues not associated with the manufacture of the product.

**This product is for residential use only. Any and all commercial use of this product voids all warranties, and frees the manufacturer from all liability.**

Read and understand all assembly and operating instructions, and all safety information and warnings, before use. The following will void this warranty: Damage caused from tampering with, modifying, or altering the fireplace insert in any manner; Damage due to incorrect assembly, improper care, misuse, or abuse; Damage from being used with the wrong power source; Water damage; Damage caused from this insert being used outdoors; Damage caused from this insert being used for excessive periods of time; Damage caused by the insert being used in a commercial application; Damage from use as a primary heat source; Other misuse or abuse not specifically listed herein.

**This product is not intended to be used as a primary heat source. It is for supplemental heating purposes only.**





Thank you for purchasing this product!

If you have questions about assembly or operation of this product, or missing parts, or if the product is damaged, please e-mail us at:

**customerservice@puraflame.com**

or call **909-206-6608**



**Ningbo Richen Electrical Appliance Co. Ltd ,**

Address: No.19, Yongdinghe Road Xiapu, Beilun Ningbo, P.R.China

**www.puraflame.com**