

# ASSEMBLY INSTRUCTION

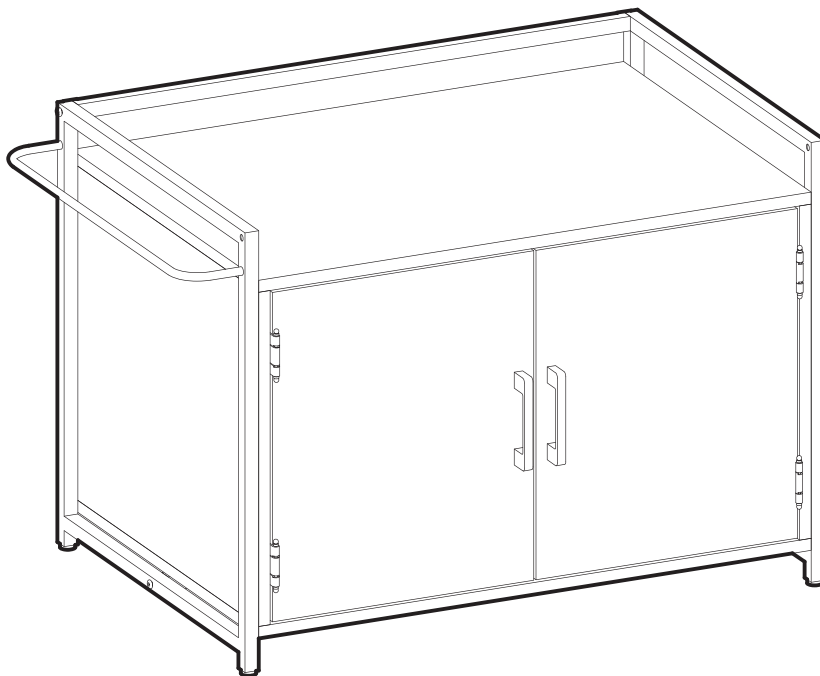

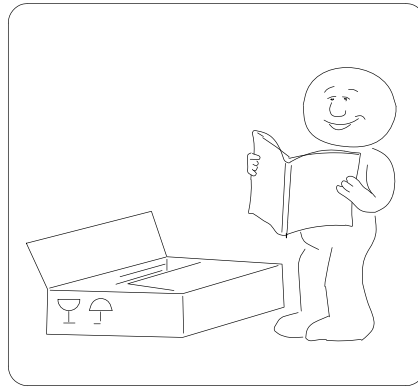

## WARNING

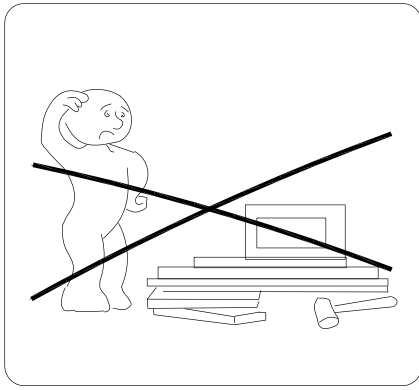

1. PLEASE READ ALL INSTRUCTIONS CAREFULLY BEFORE STARTING ASSEMBLY.
2. DO NOT LET ANY SHARP OBJECTS TOUCH OR RUB THE SURFACE OF THE PRODUCT.
3. WHEN ASSEMBLING, DO NOT LET CHILDREN PLAY AROUND THE WORKING AREA.
4. PLEASE CONFIRM ALL PARTS ARE CORRECT BEFORE STARTING THE ASSEMBLY PROCESS.
5. DO NOT TIGHTEN ALL BOLTS AND SCREWS COMPLETELY UNTIL THE ENTIRE UNIT HAS BEEN ASSEMBLED AND SET UP.

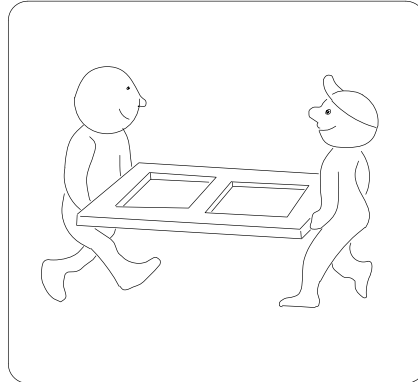
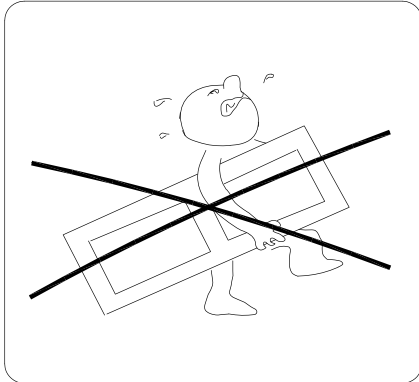
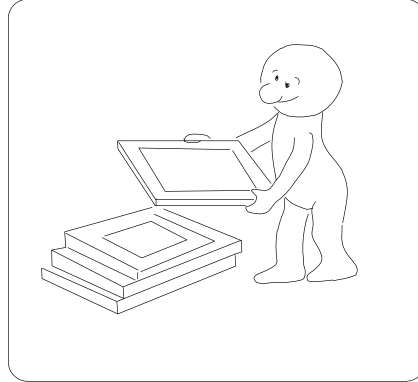
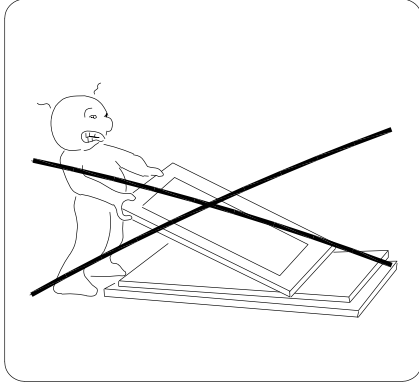

## ADVISE

1. DO NOT SIT OR STAND ON THIS PRODUCT. IT IS INTENDED FOR PETS ONLY.
2. THIS PRODUCT SHOULD BE ASSEMBLED BY AN ADULT.
3. PLEASE PUT THE PRODUCT ON A SMOOTH SURFACE AFTER YOU ASSEMBLED IT.
4. PLACE ALL PARTS ON A CLEAN AND SMOOTH SURFACE SUCH AS A RUG OR CARPET TO AVOID THE PARTS FROM BEING SCRATCHED.
5. THE SCREW OF HINGE ON THE DOOR ALSO CAN BE ADJUSTABLE, TO MAKE IT EVEN THEN TIGHTEN ALL SCREWS.

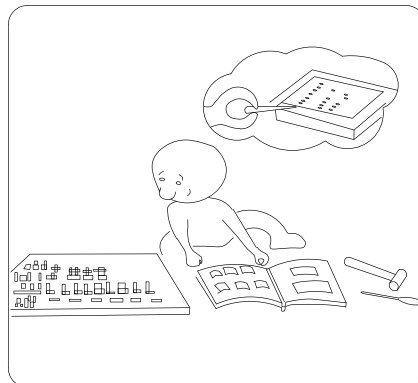
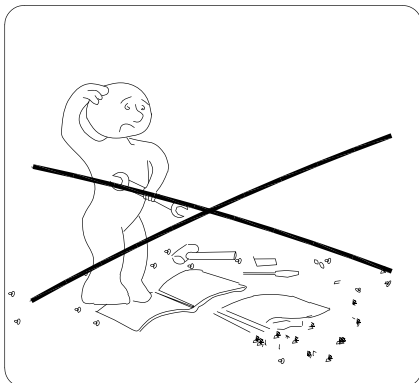

## TOOL NEEDED

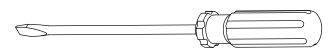
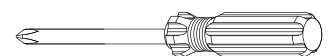

SCREWDRIVER REQUIRED  
- NOT INCLUDED

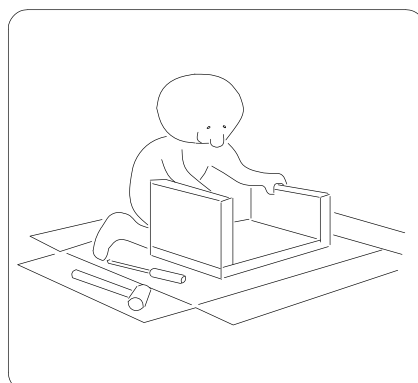
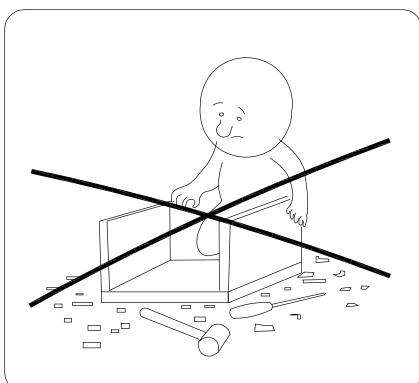

**PARTS**

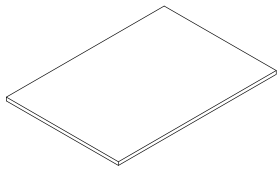
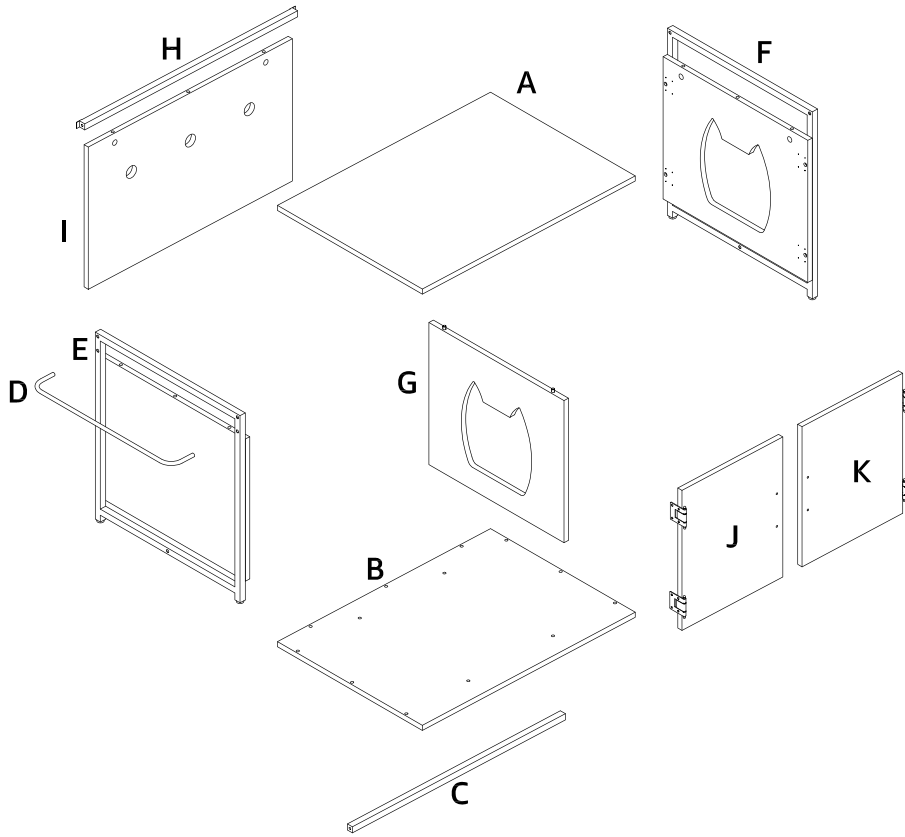

**A**  
Top Panel  
x1

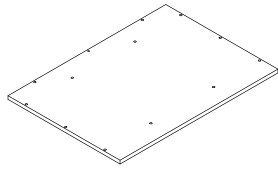

**B**  
Bottom Panel  
x1

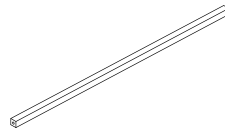

**C**  
Bottom Cross Bar  
x1

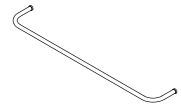

**D**  
Towel Rack  
x1

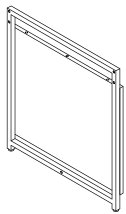

**E**  
Side Panel  
x1

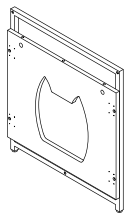

**F**  
Side Panel  
x1

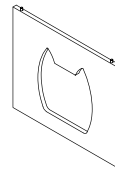

**G**  
Divider Panel  
x1

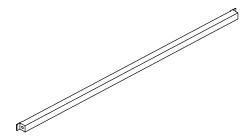

**H**  
Top Bar  
x1

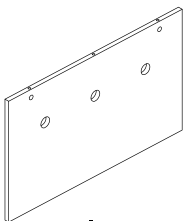

**I**  
Back Panel  
x1

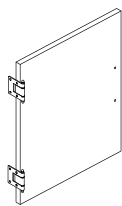

**J**  
Left Door  
x1

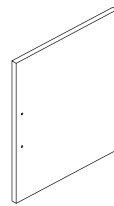

**K**  
Right Door  
x1

## HARDWARE

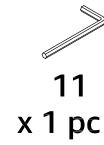
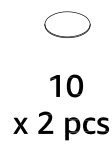
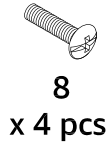
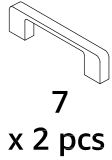
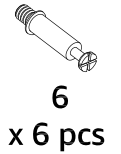
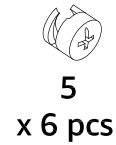
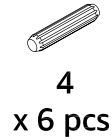
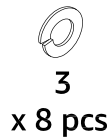
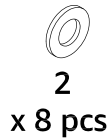
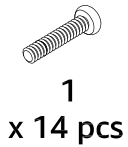

## ASSEMBLY INSTRUCTIONS

1

Insert wood dowel 4 into side panel E & F, connect side panel E & F with bottom panel B, tighten bolt 1 into the hole of bottom panel B through with washer 3 and 2 by Allen Wrench 11.

Connect bottom cross bar C with the side panel E & F, tighten bolt 1 by Allen Wrench 11.



Side panel E & F can be exchangeable, divider panel G can be changed according to the side panel.

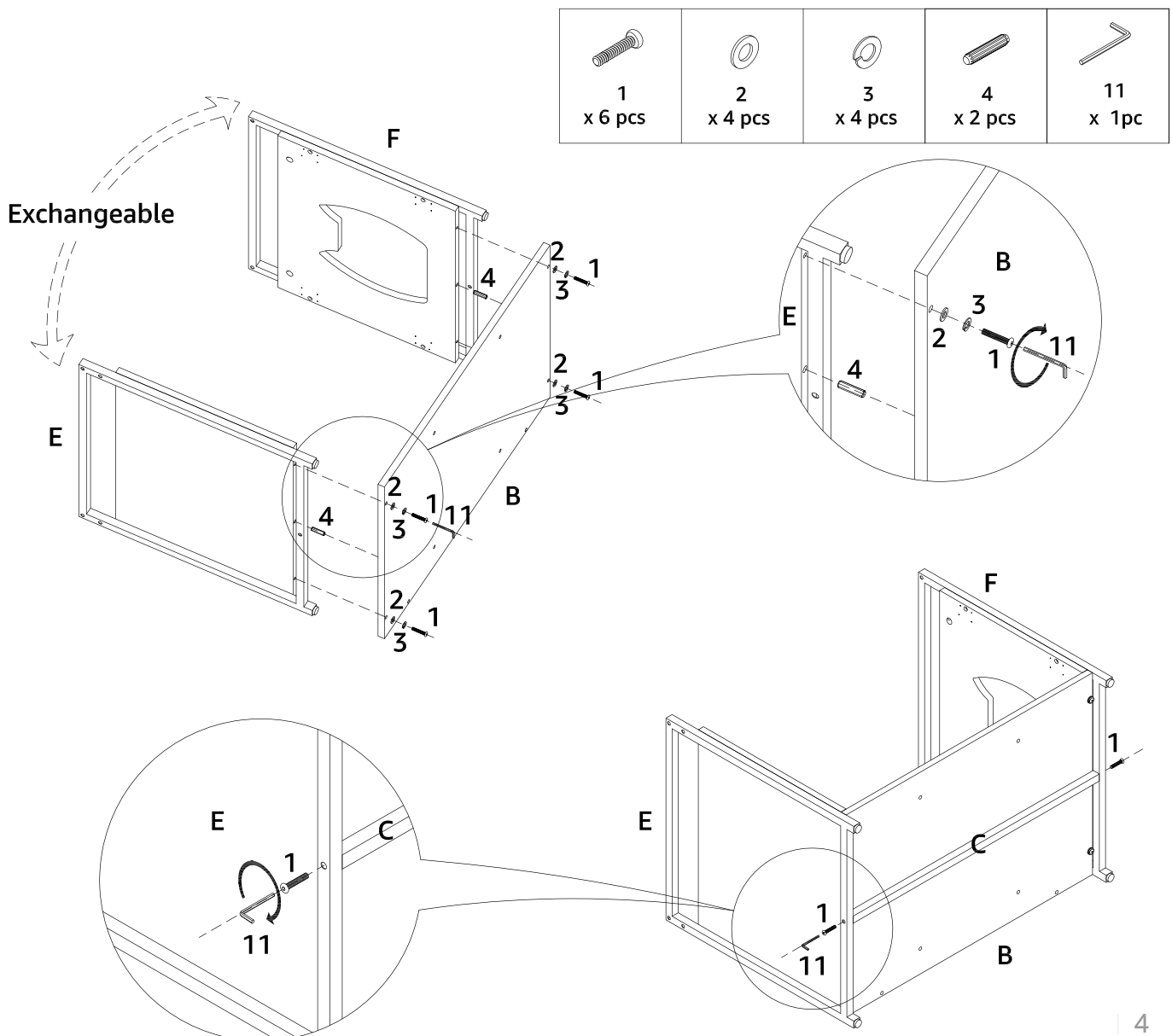











2

Insert the back panel I into the body, tighten bolt 1 into the hole of the bottom panel B through with washer 3 and 2 by Allen Wrench 11.

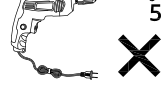
Tighten the pin 6 to top panel A.

Connect top panel A to the body, insert cam lock 5 into the hole on the both side panel E & F and back panel I, tighten cam lock 5 to pin 6.

 1 x 2 pcs	 2 x 2 pcs	 3 x 2 pcs	 4 x 4 pcs	 5 x 6 pcs	 6 x 6 pcs	  NO!	  YES!
---	---	---	---	---	---	--	---

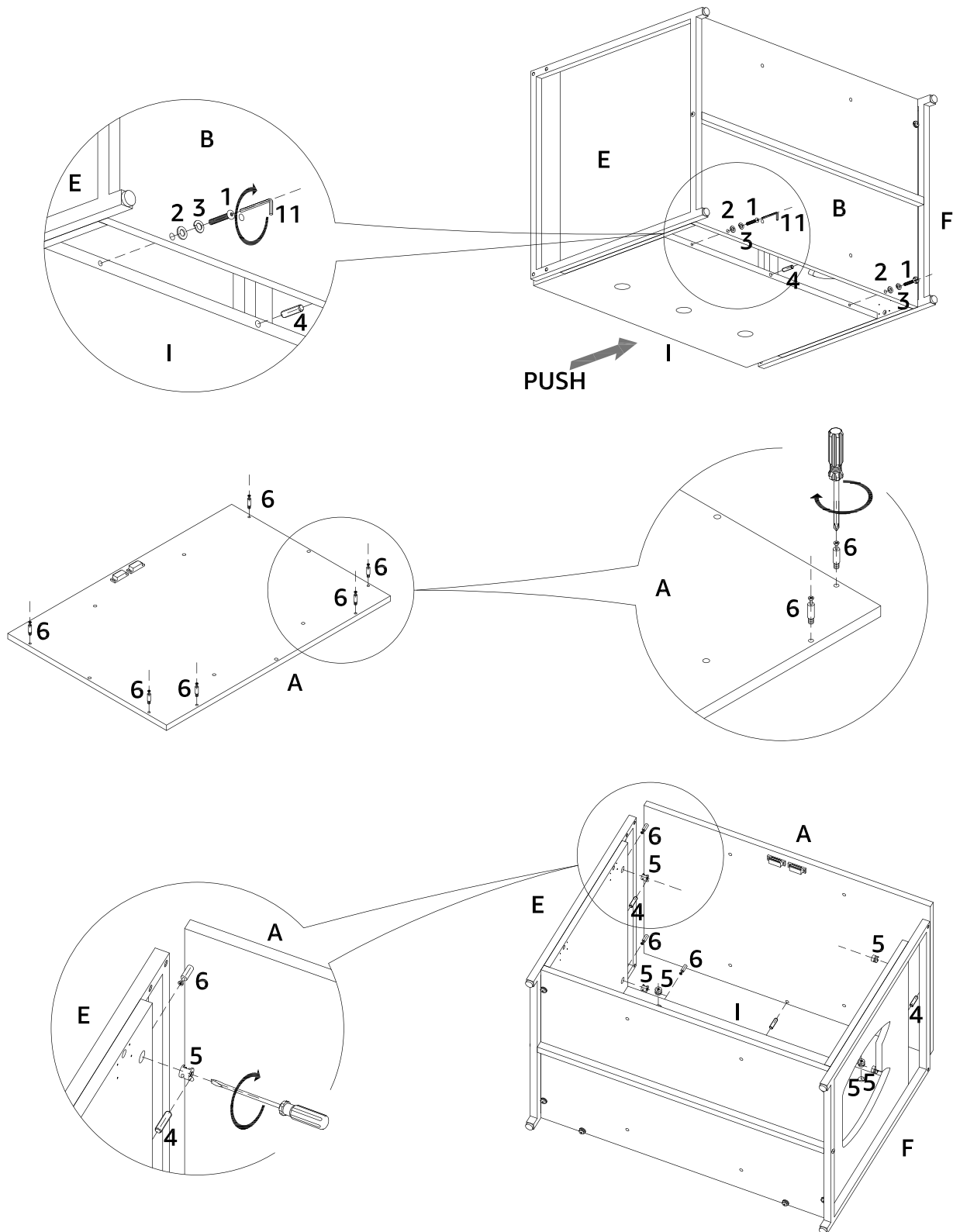

3

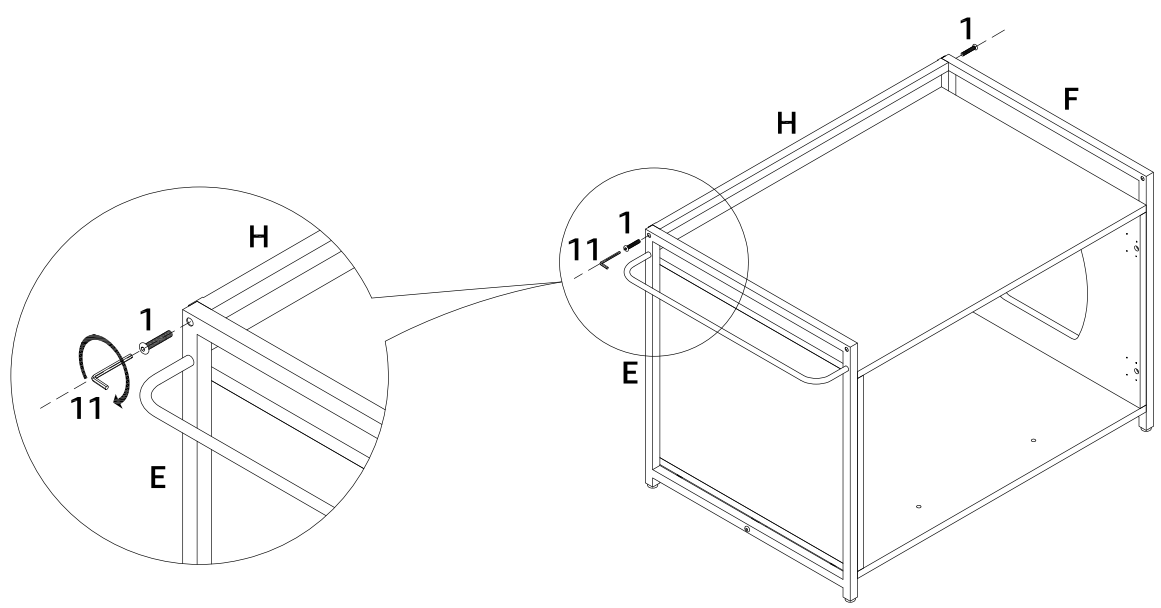
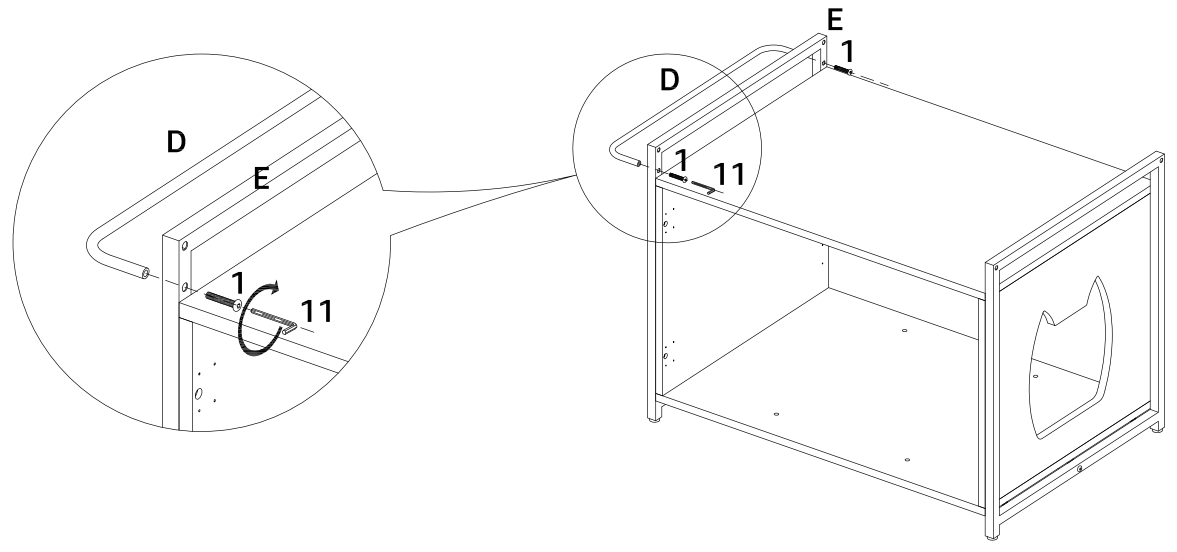
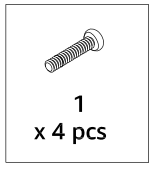

Connect towel rack D with side panel E, tighten bolt 1 by Allen Wrench 11.  
Connect top bar H with the side panel E & F, tighten bolt 1 by Allen Wrench 11.



4

Connect left and right door J & K to the side panel E & F, tighten them with screw 9 into the hinge.



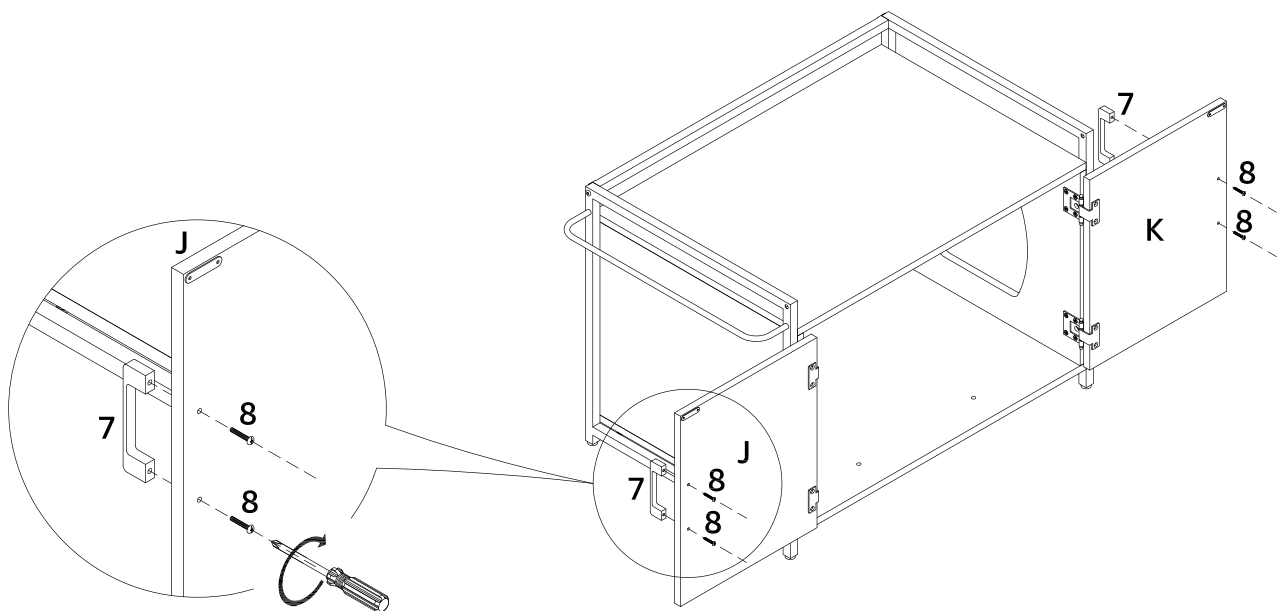
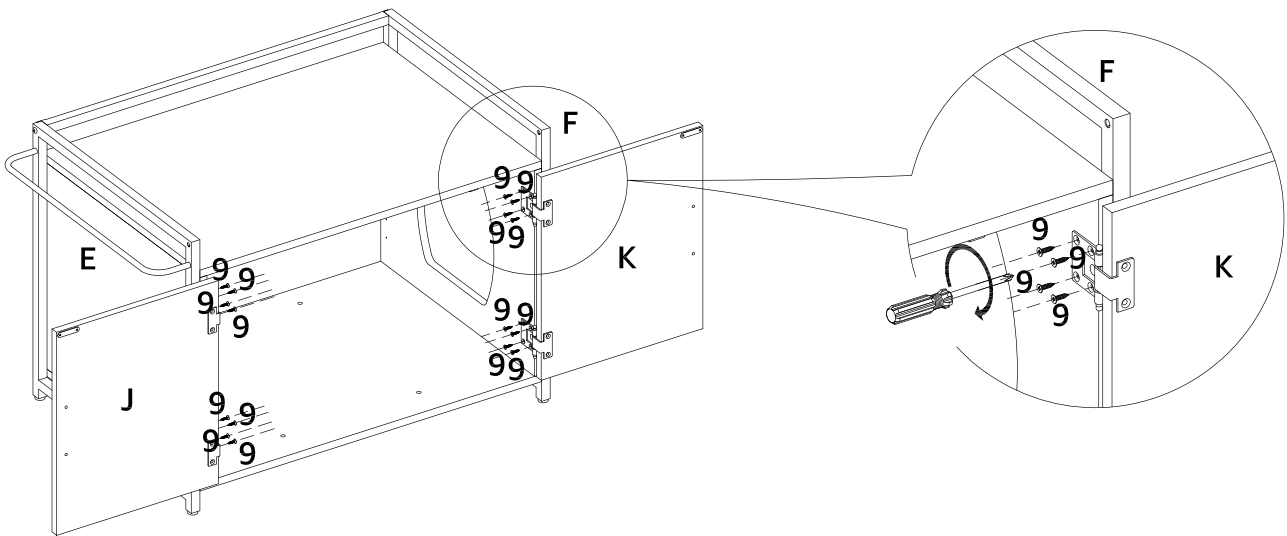

Assembly the knob 7 with screw 8 to the door panel.

		
7 x 2 pcs	8 x 4 pcs	9 x 16 pcs



5

Input the divider G to the body on the left or right side.  
Tighten screw 12 to connect the divider panel G the bottom panel B.  
Put the cover 10 into the hole of the bottom panel B.

 1 x 2 pcs	 2 x 2 pcs	 3 x 2 pcs	 10 x 2 pcs
---	---	---	--

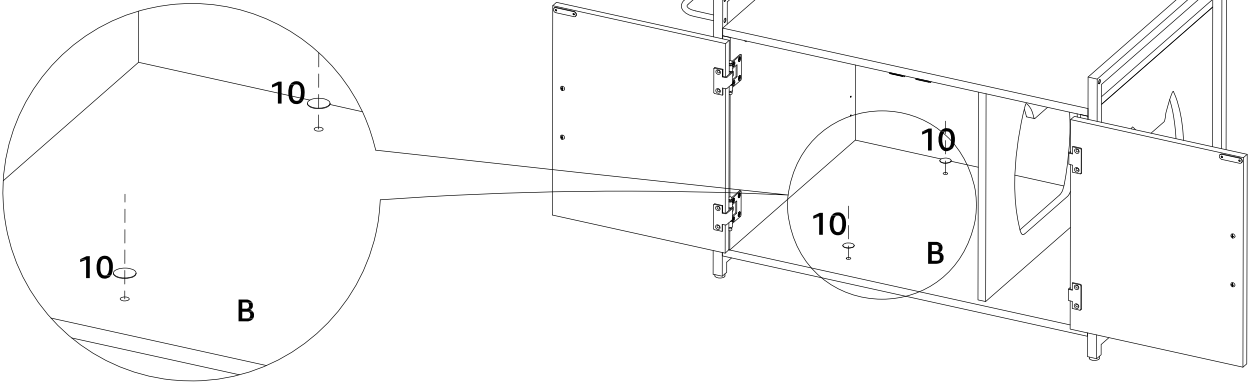
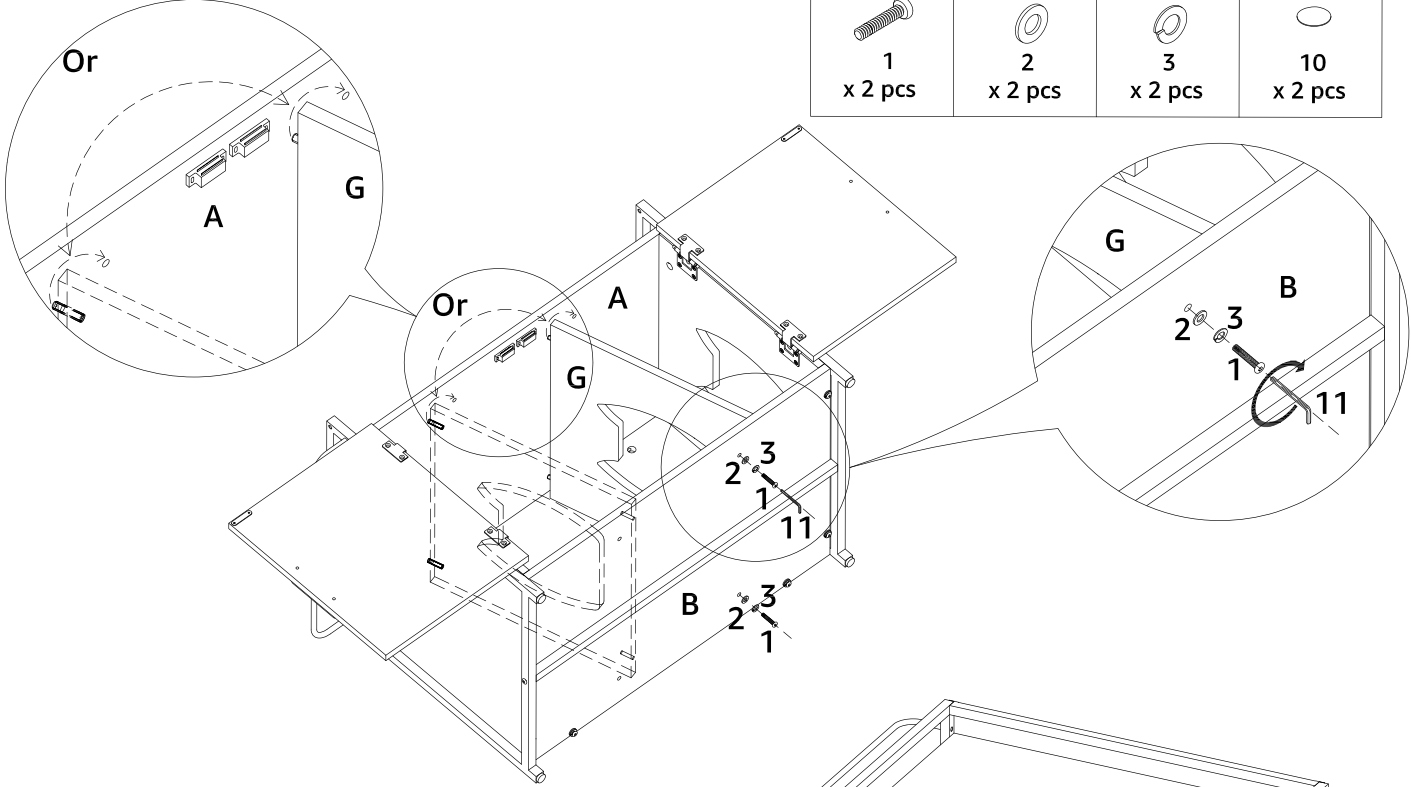

Or

