

12X12 FT

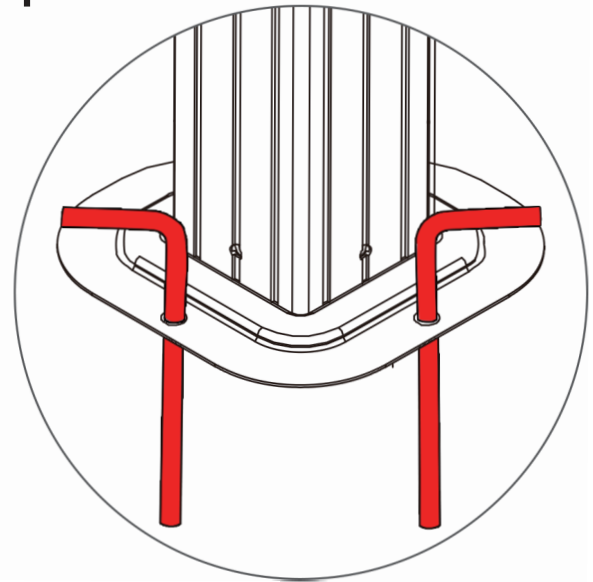

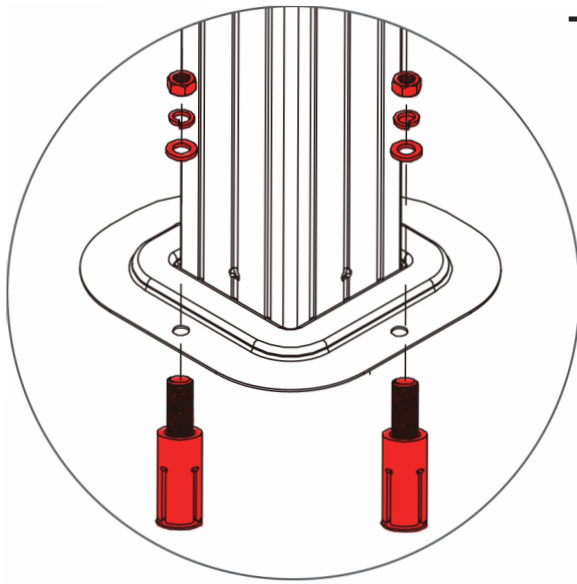







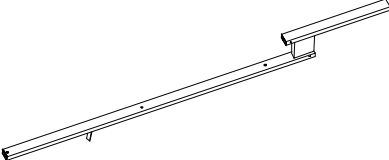
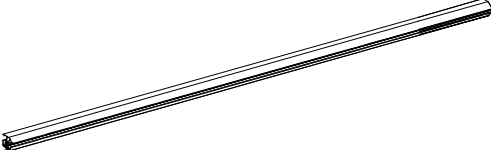

1. Must use ground nails, ropes, and expansions screws for whichever ground you install on for stability to avoid devastating injuries for people inside or nearby and property damage caused by a collapsing gazebo.
2. Do not use this gazebo in high winds, heavy snow, or inclement weather. It is not designed to withstand strong gusts of wind, heavy snow accumulation, or other inclement weather. Must take precautions when the wind speed exceeds 25Mph, and clear snow when it accumulates more than 2 inches.
3. Before use, thoroughly inspect the gazebo to make sure all bolts, nuts, and buckles have been completely tightened and securely fastened.
4. Warranty does not cover damages, losses, or injuries resulting from improper installation, misuse, not using stability accessories mentioned above, non snow cleaning, failure to take precautionary measures, etc.



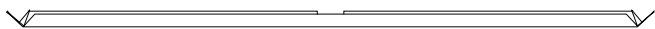
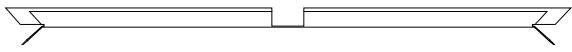

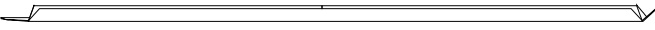
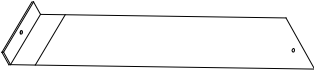
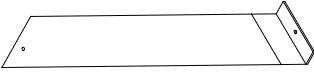
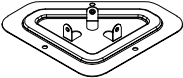
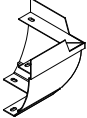
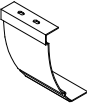

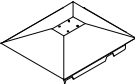



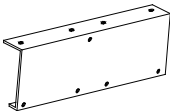

"IMPORTANT, RETAIN FOR FUTURE REFERENCE: READ CAREFULLY"









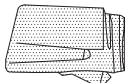



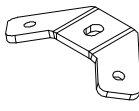

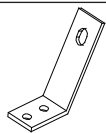
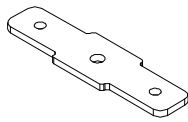
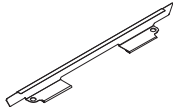

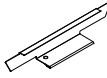
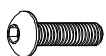



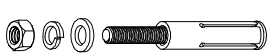
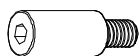

1. Two or more people are required for assembly.
2. A ladder and electric drill may be necessary.
3. Do not erect the structure in heavy winds or inclement weather.
4. Do not leave up this unit for extended periods of time, as it is not a permanent structure or designed to withstand sustained wind or rain. It is a temporary, portable shelter that shields you from sunlight and rain. The screens also block flying insects.
5. Do not use candles, matches, or any open flames near the tent.
6. To better align the screws for practical situations, do not fully tighten screws initially.
7. Professional installation is highly recommended.

Item no.	Reference Image	Qty.
A		X4
B		X4
B1		X4
E1		X4
Ea		X4
Eb		X4
F1		X8

Item no.	Reference Image	Qty.
G1		X4
G3		X4
G5		X4
G6		X4
H		X4
H1		X4
J		X4
K		X4
K1		X4
L		X1
M		X1
N		X12
N1		X4

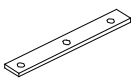
Item no.	Reference Image	Qty.
P		X4
Q1		X4
Q2		X4
Q3		X4
Q4		X4
Q5		X4
Q6		X4
Q7		X4
Q8		X4
S		X4
Sa		X4
T		X4
T1		X4

Item no.	Reference Image	Qty.	Item no.	Reference Image	Qty.
U		X112	V1		X2
W		X4	V2		X2
W3		X4	W1		X4
Z		X72	Y		X116
1	 M6X16mm	X144	Z1		X16
3	 M6X25mm	X9	2	 M6X23mm	X72
5	 M6X10mm	X8	4	 ST4.8X12mm	X16
7	 M6X47mm	X32	6	 M6X42mm	X4
9		X12	8		X16
12	 M5X12mm	X12	10		X12
14		X1	13		X1
16		X12	15		X1
18		X4	17		X12

**1**

**X4**



**A** 4pcs

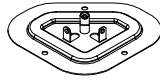

**J** 4pcs



**1** 12pcs

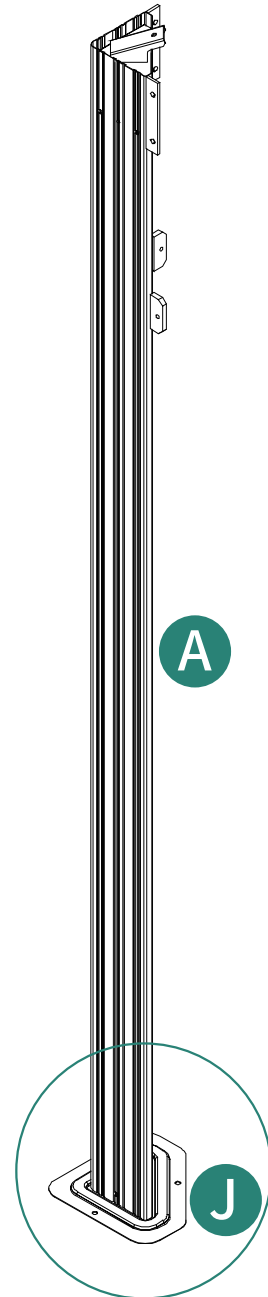
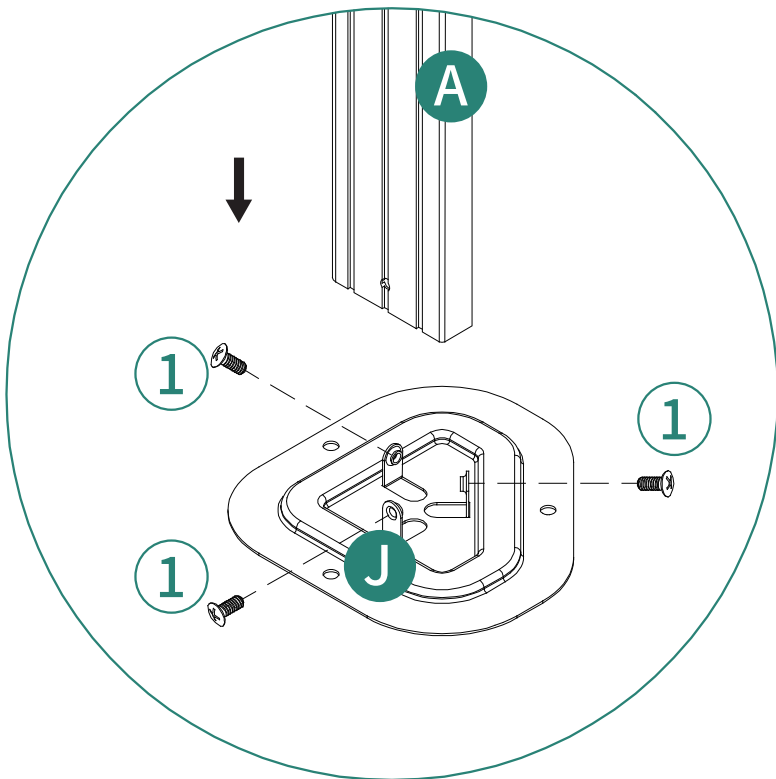



3

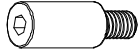

① 16pcs    ⑧ 16pcs

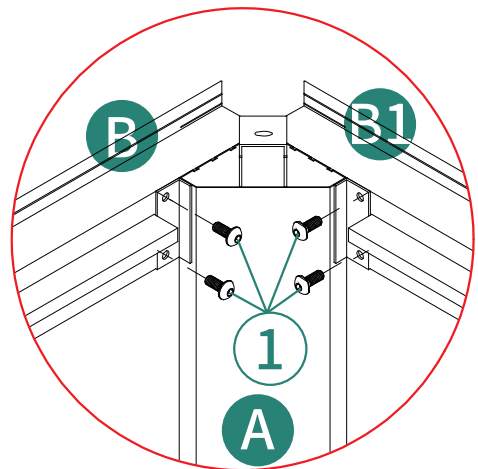
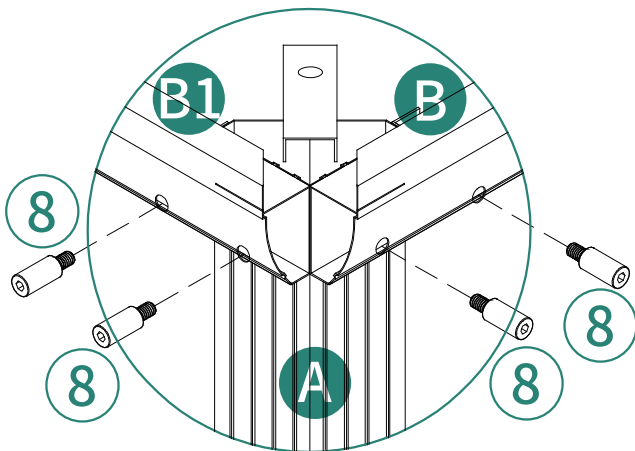
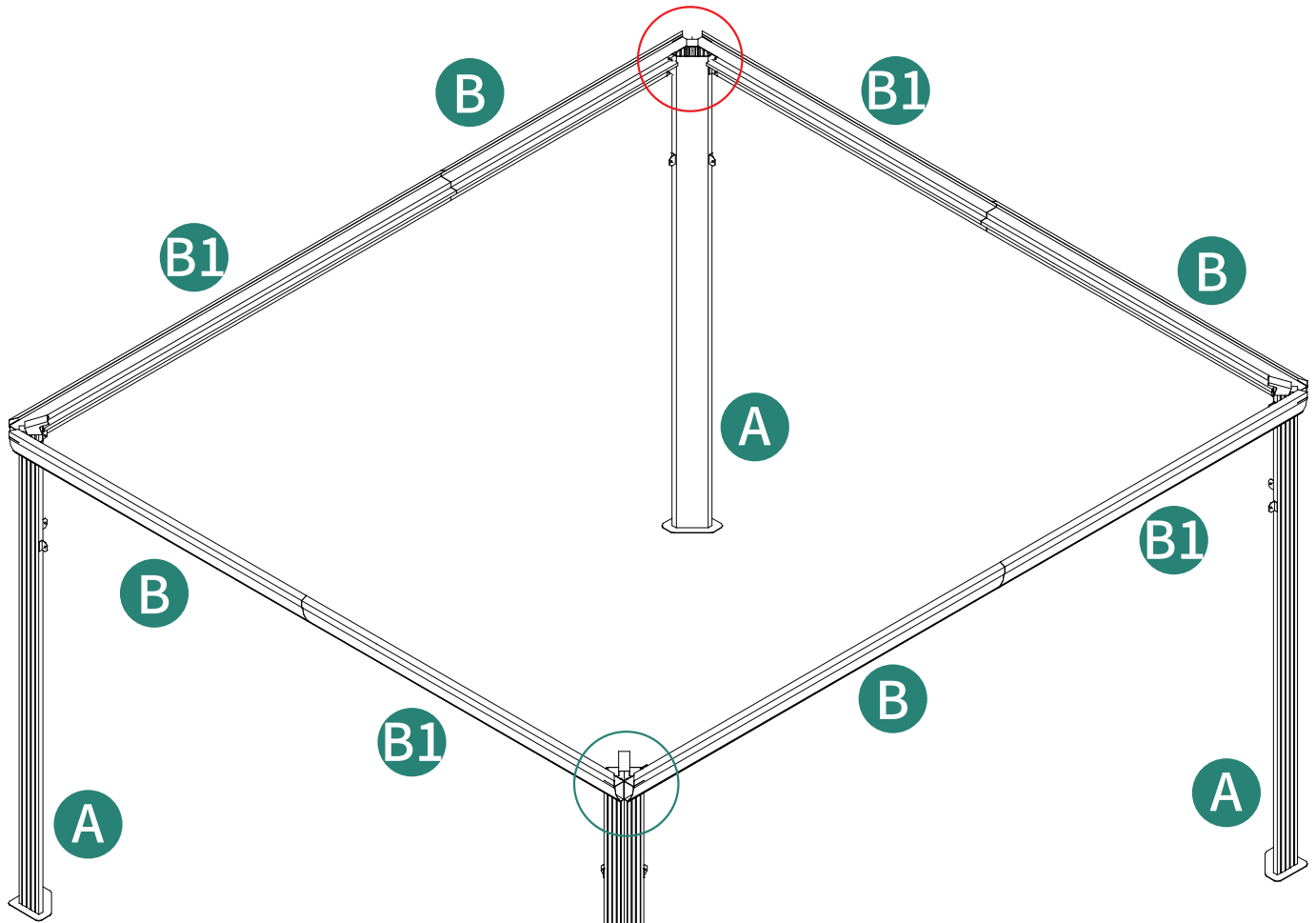

4

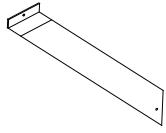

Ⓜ 4pcs

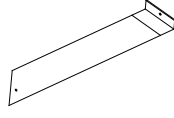

Ⓜ 4pcs



① 16pcs

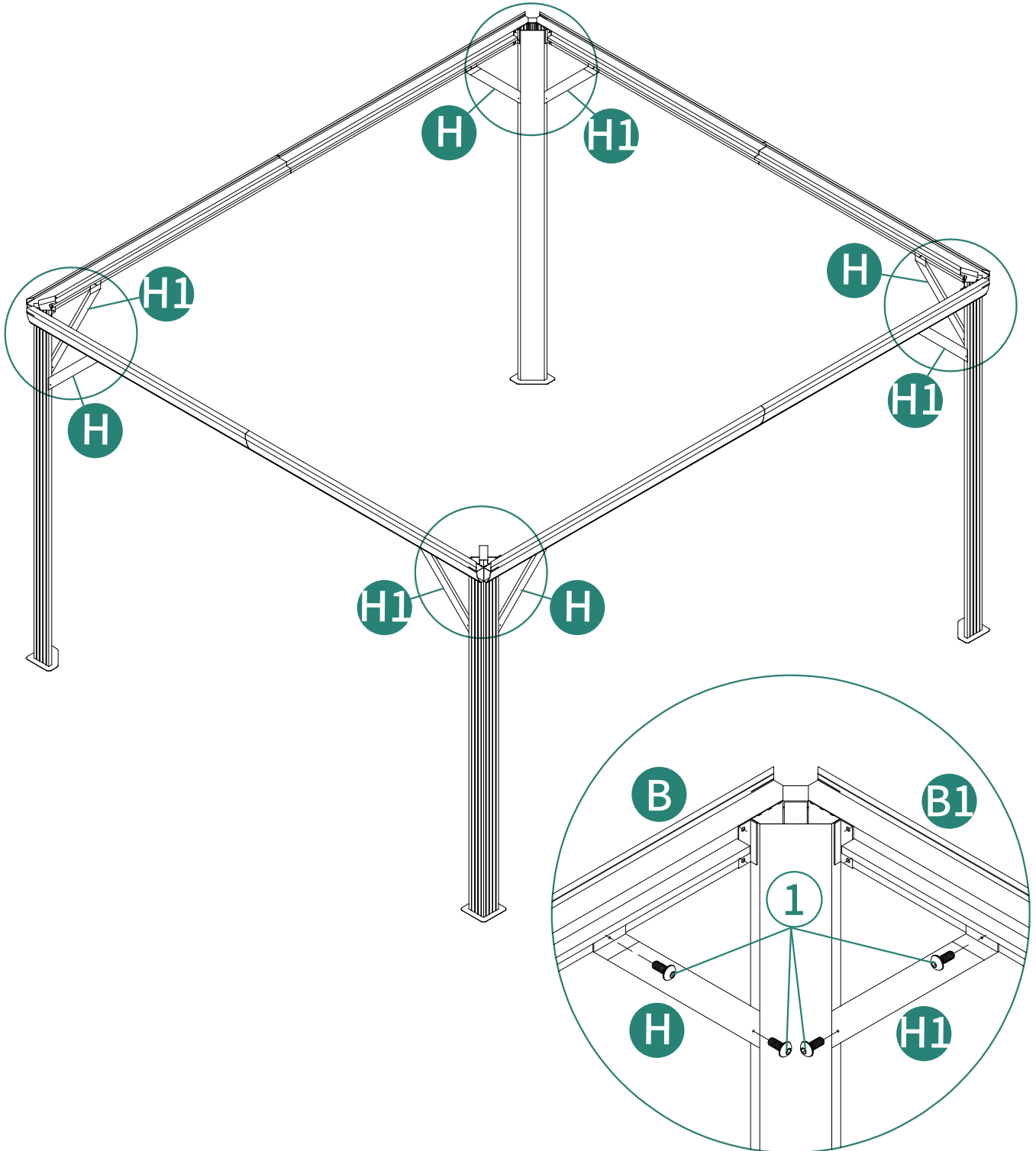

5

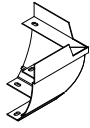

Ⓚ4pcs

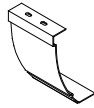

Ⓚ14pcs



④16pcs



⑫4pcs

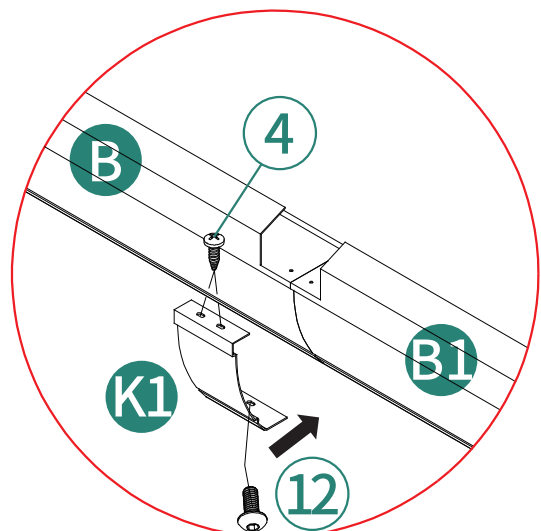
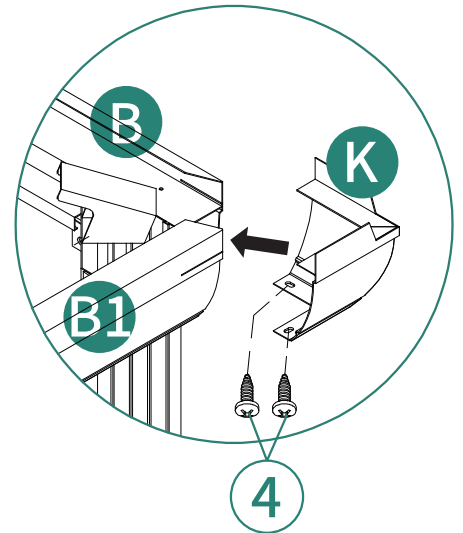
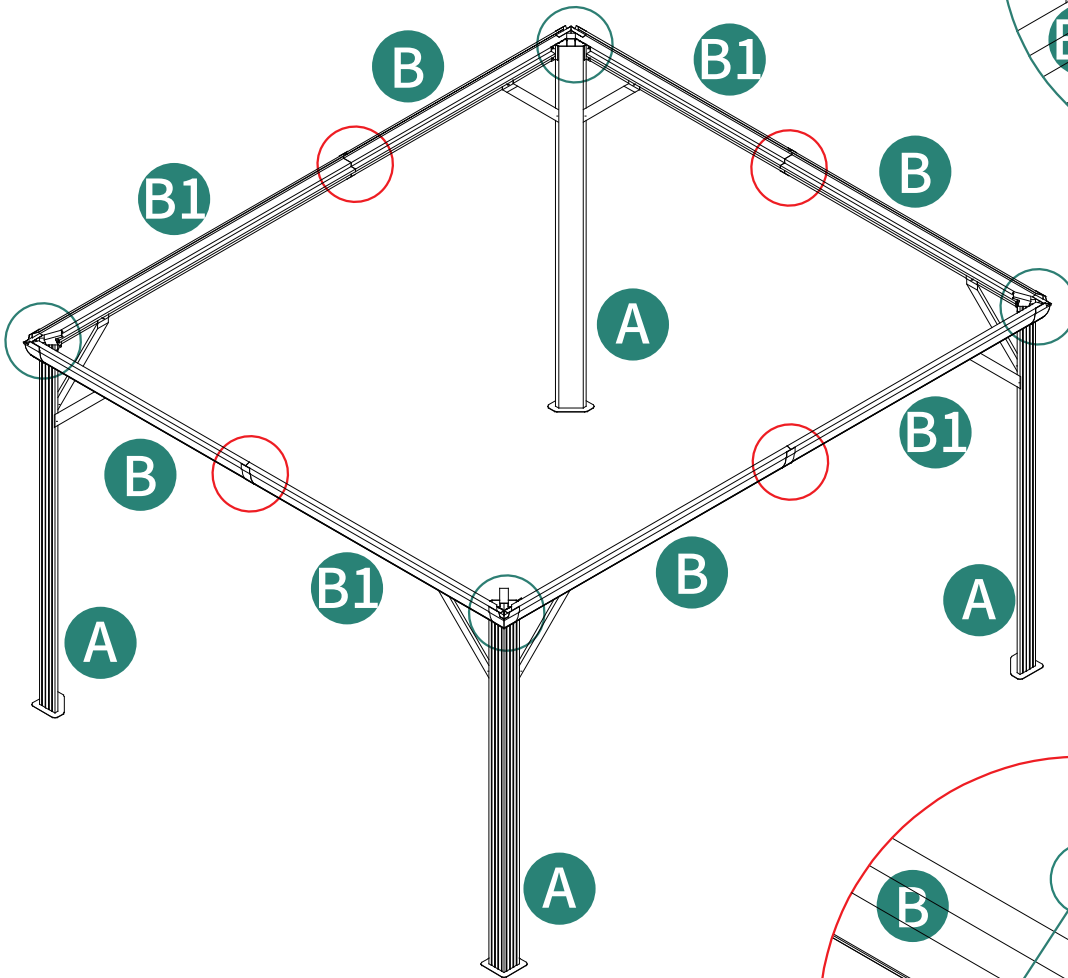

6

X4



Ⓔa 4pcs



Ⓔb 4pcs



Ⓔ16 12pcs



Ⓔ17 12pcs

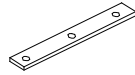

Ⓔ18 4pcs

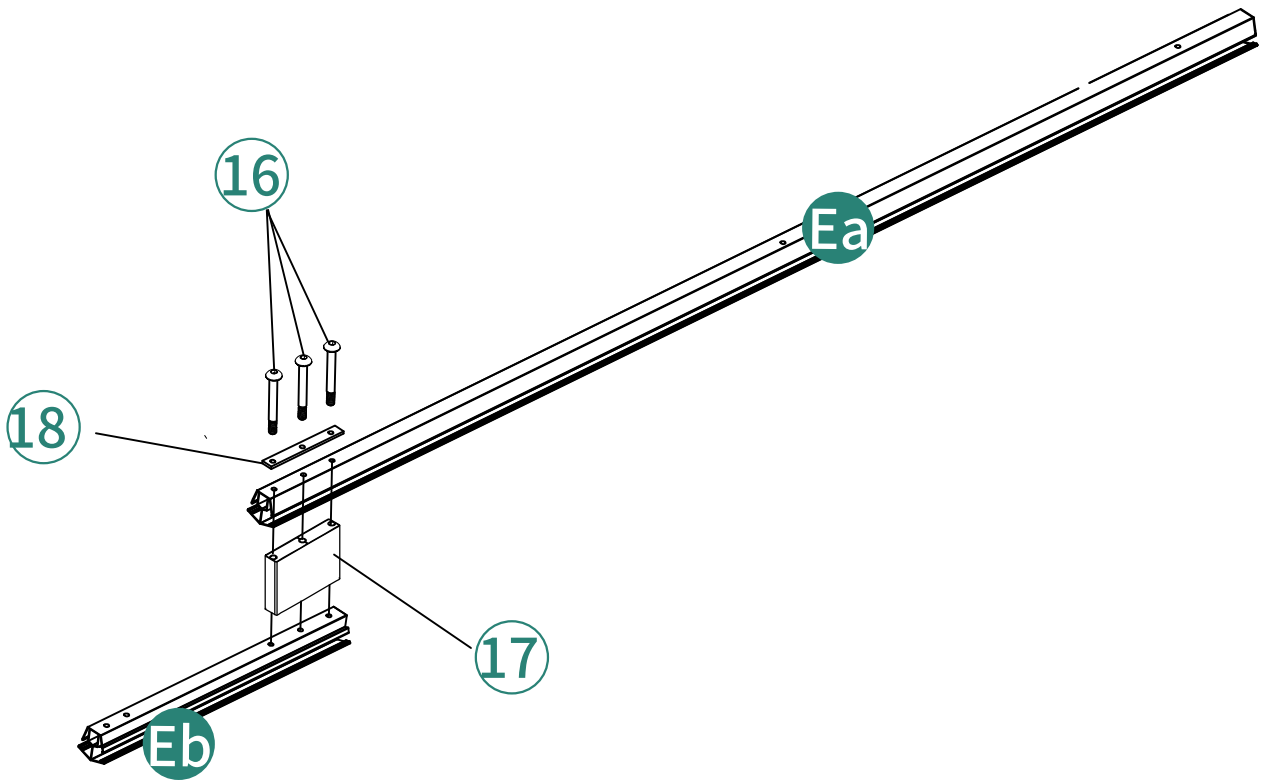

**7**

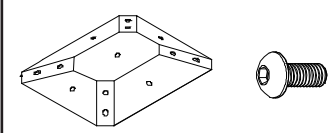

Ⓛ 1pc    ① 8pcs

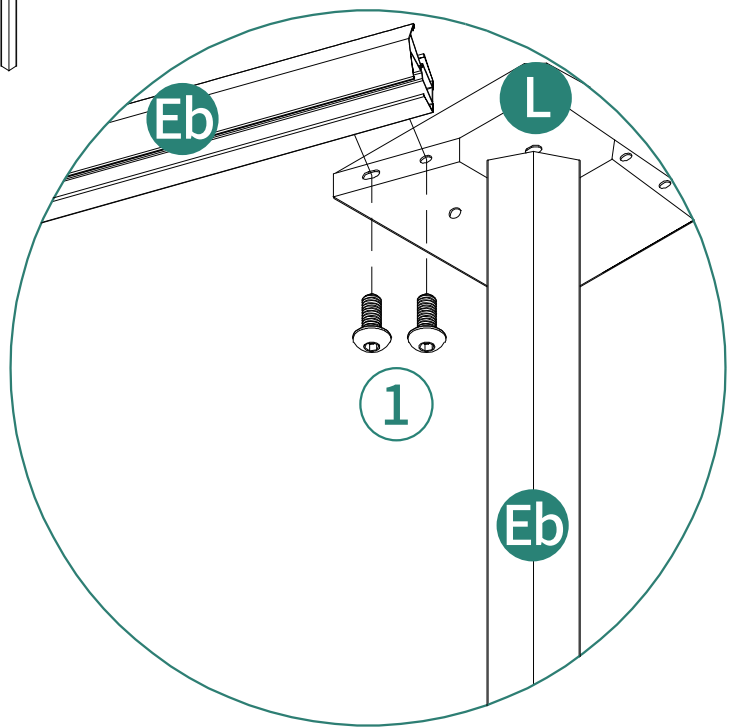
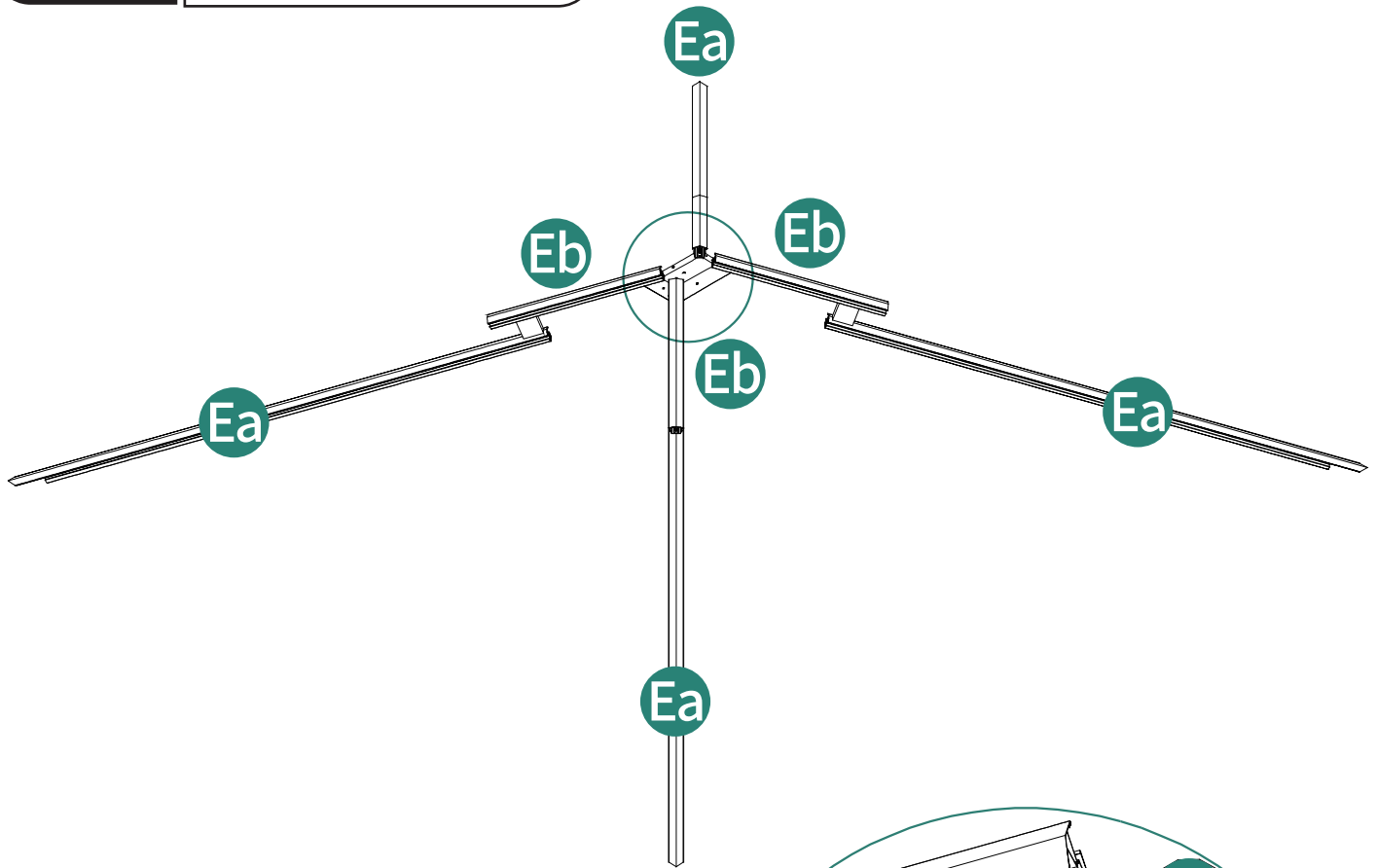

**8**



① 4pcs

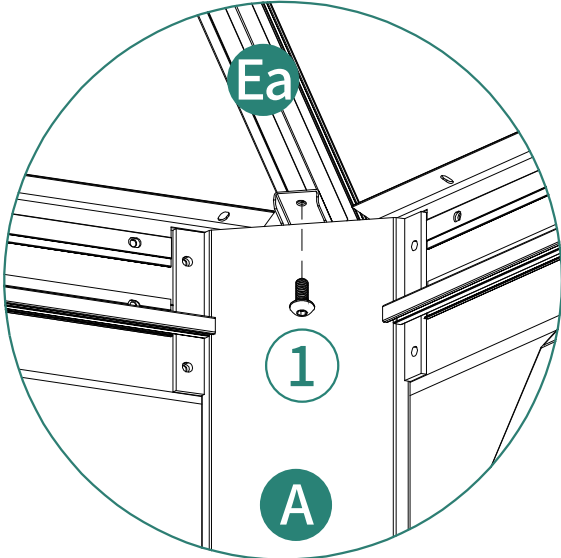
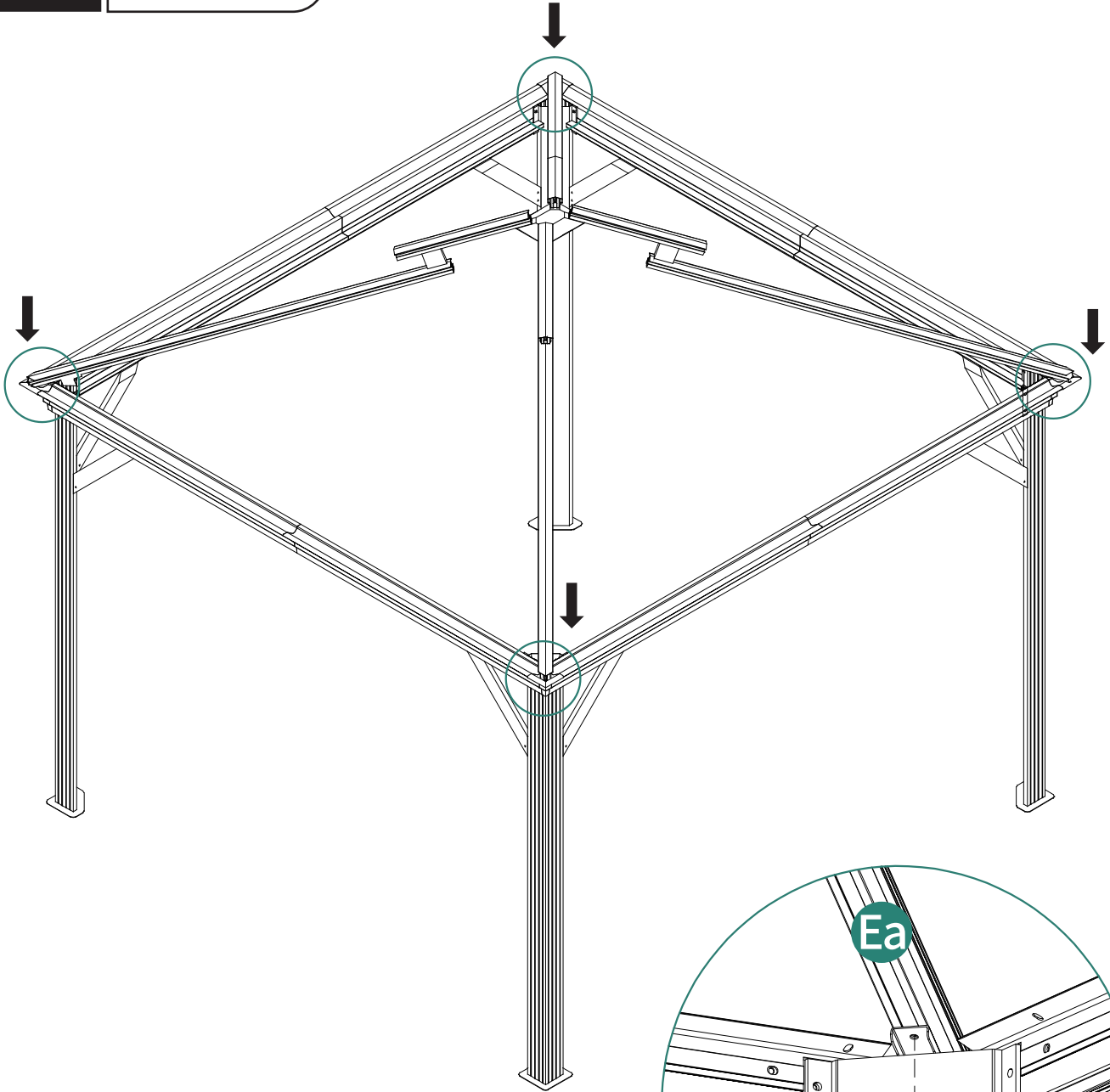

9

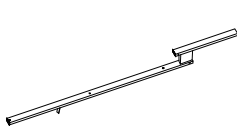

E1 4pcs

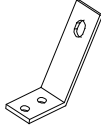

W3 4pcs



1 8pcs



12 8pcs

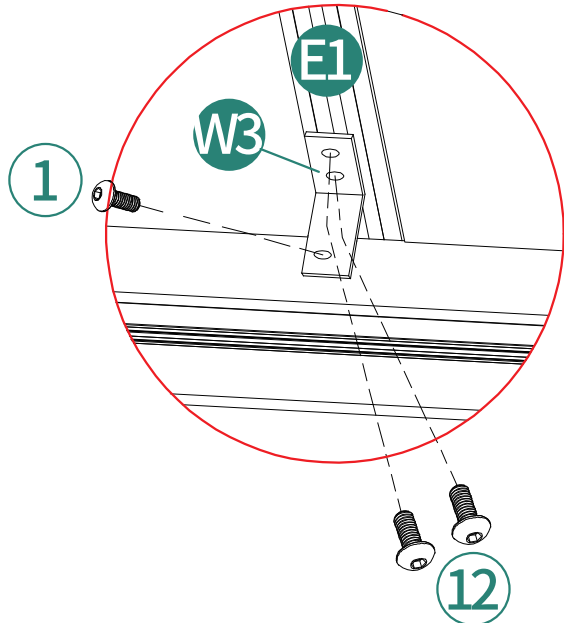
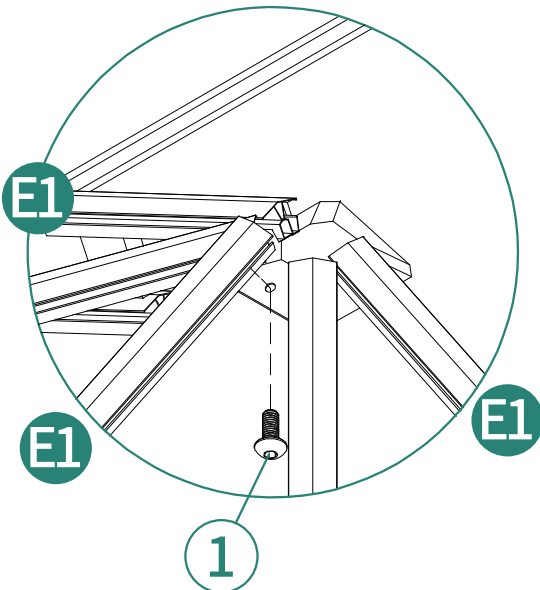
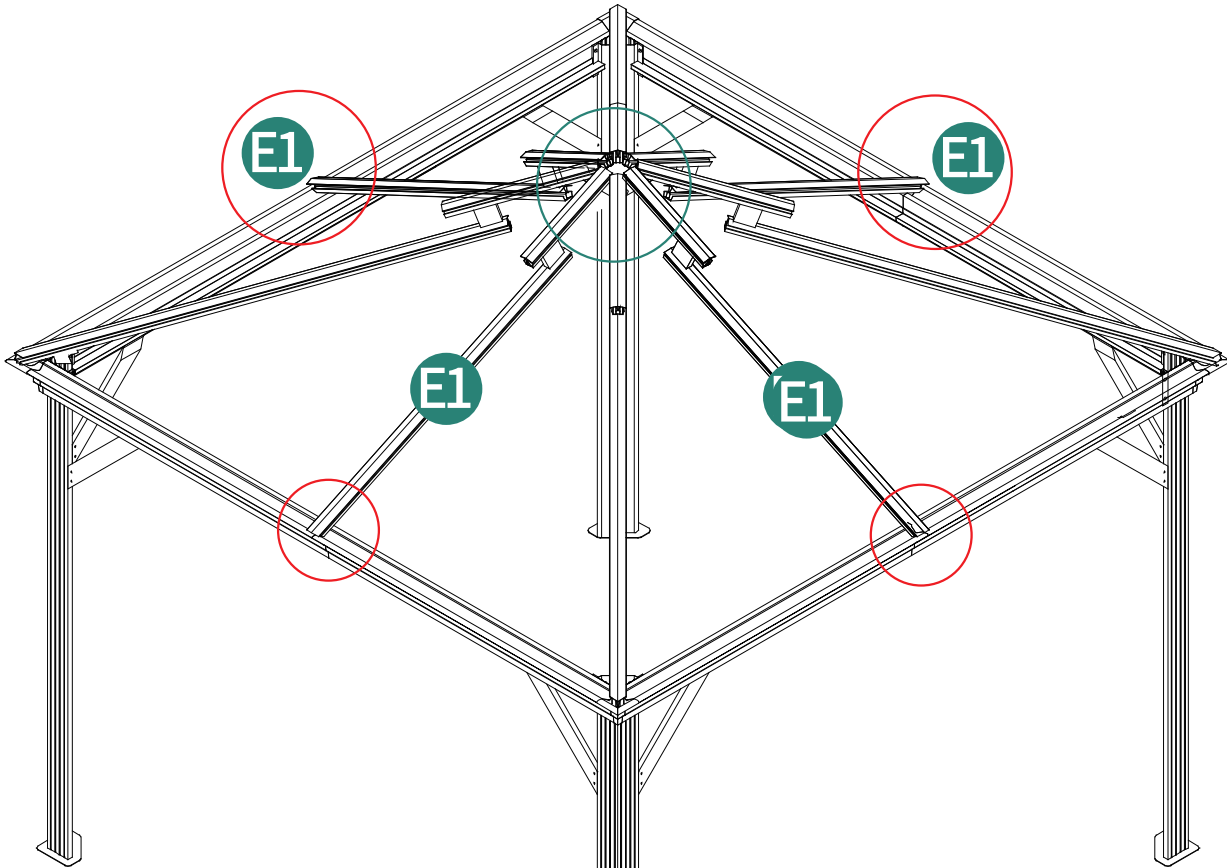

10

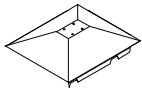

Ⓜ1pc

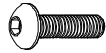

③1pc

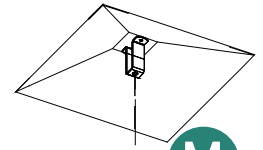

Ⓜ

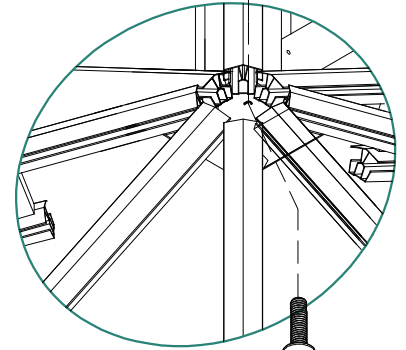

③

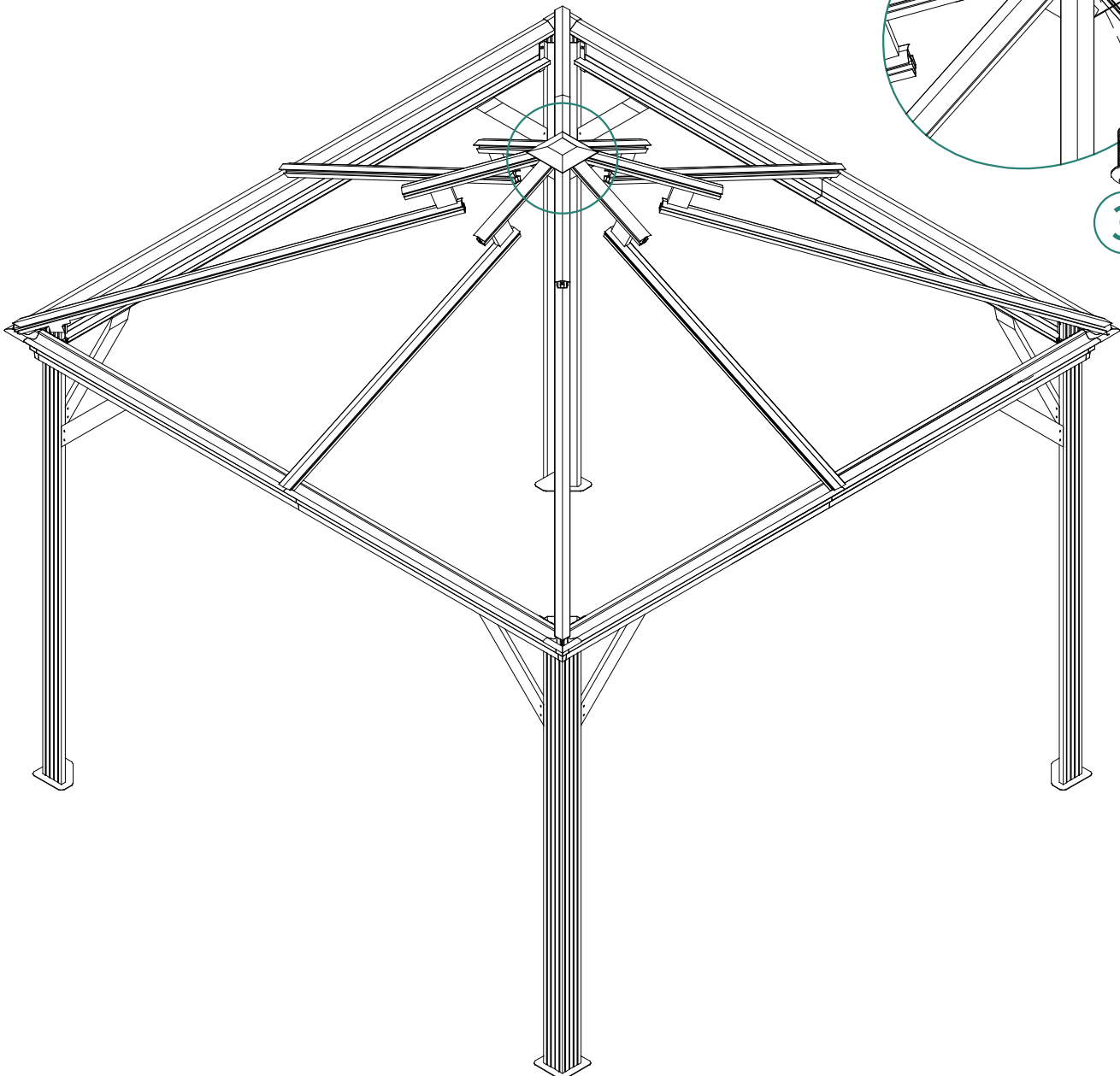

# 11

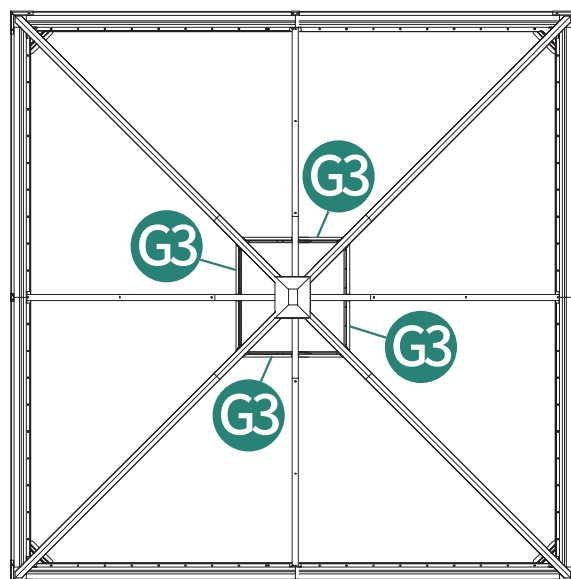
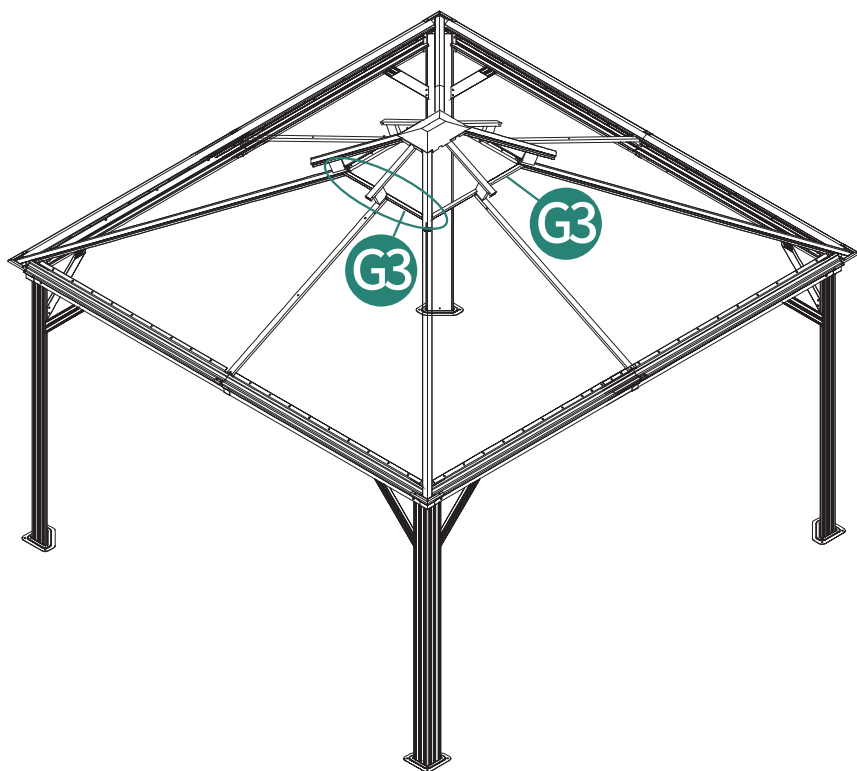
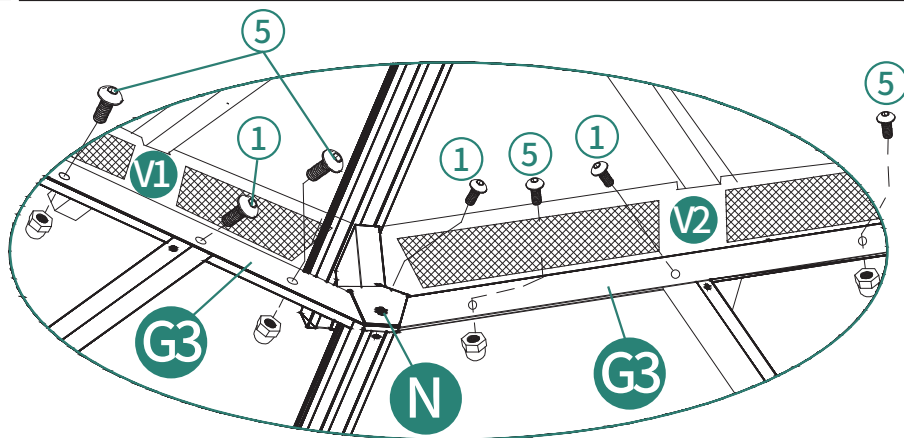
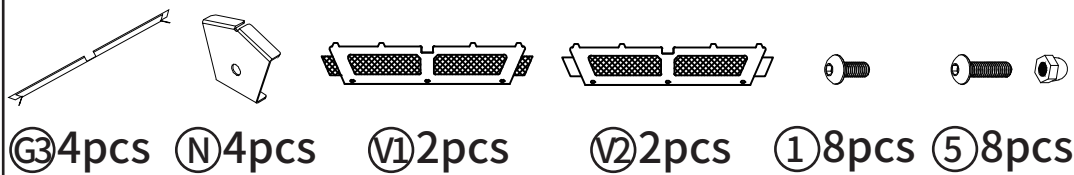

# 12

## X4

- Q1 4pcs
- Q2 4pcs
- Q3 4pcs
- Q4 4pcs
- Q5 4pcs
- Q6 4pcs
- Q7 4pcs
- Q8 4pcs
- S 4pcs
- Sa 4pcs
- Z 72pcs
- Z1 16pcs

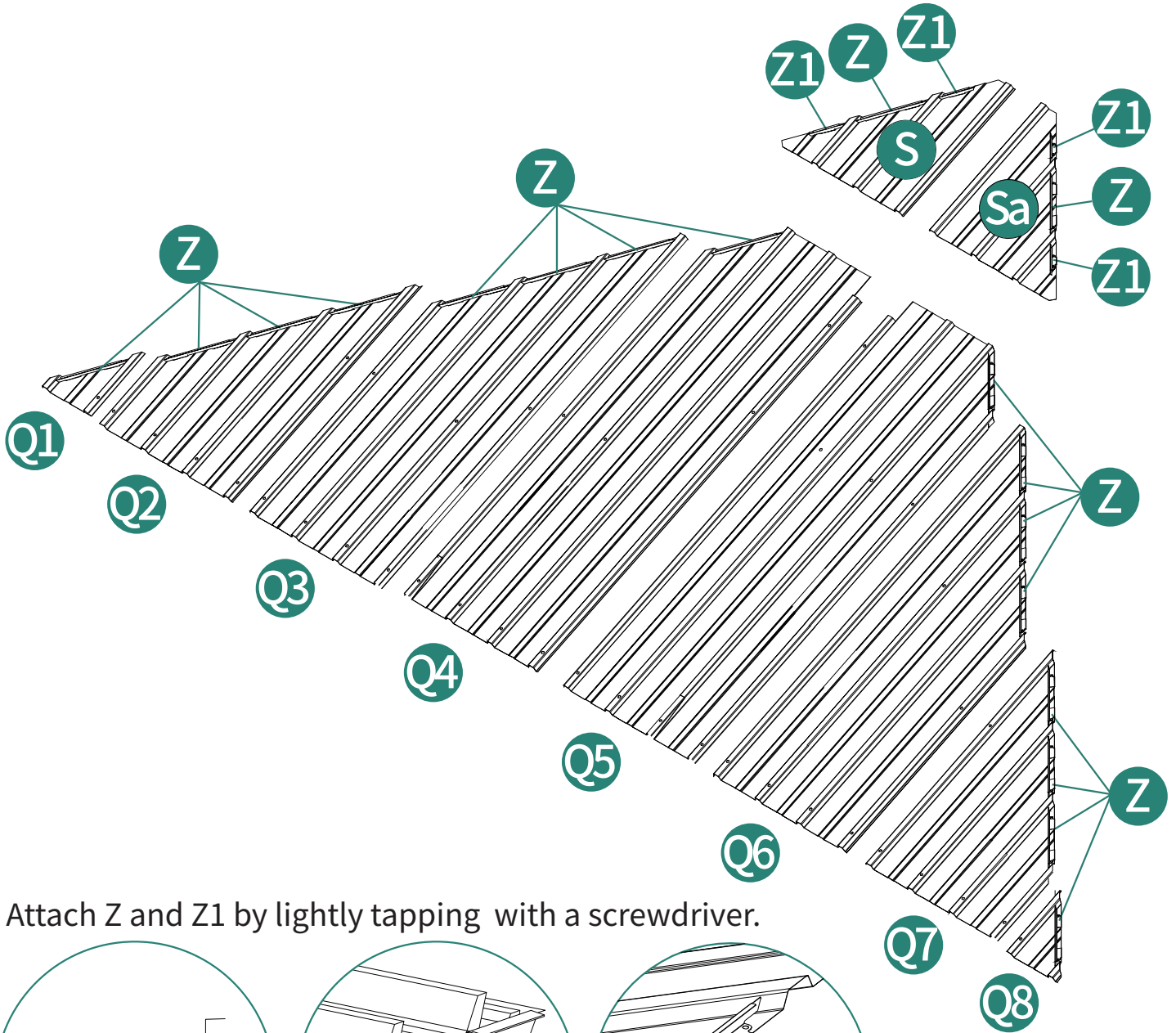

Attach Z and Z1 by lightly tapping with a screwdriver.

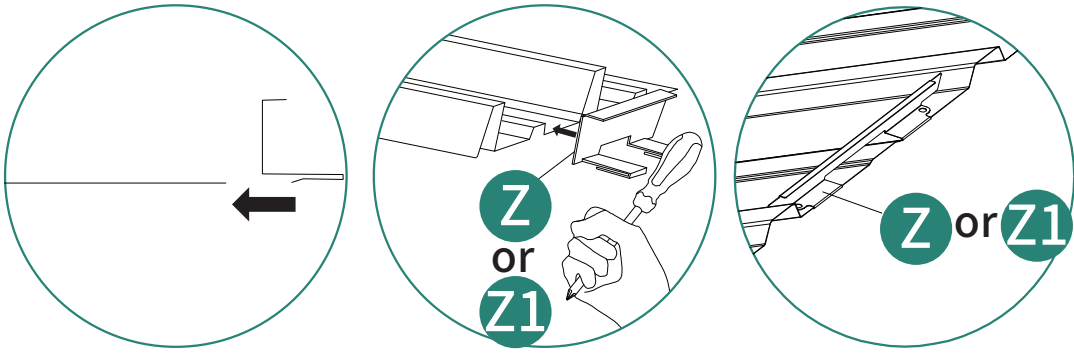

# 13

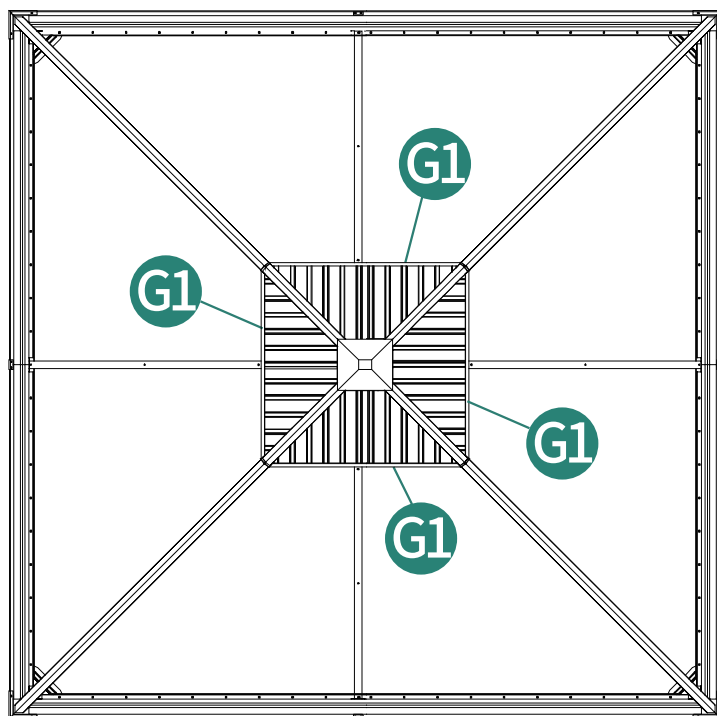
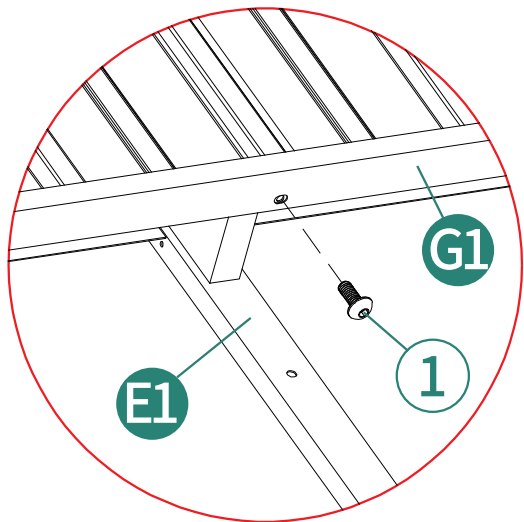
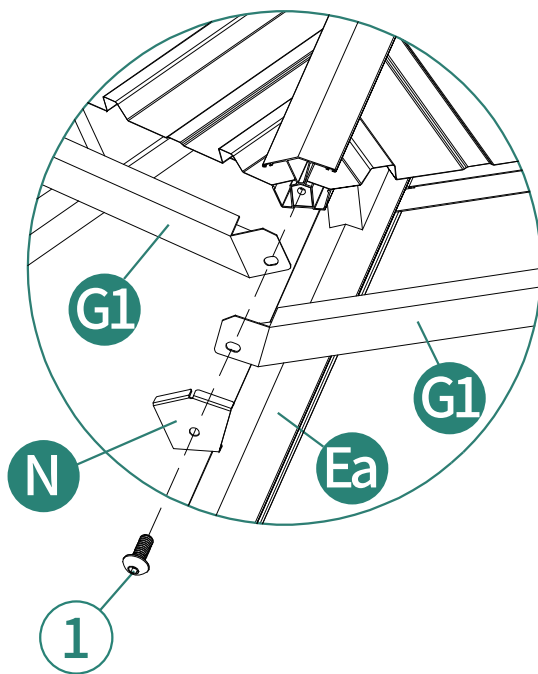
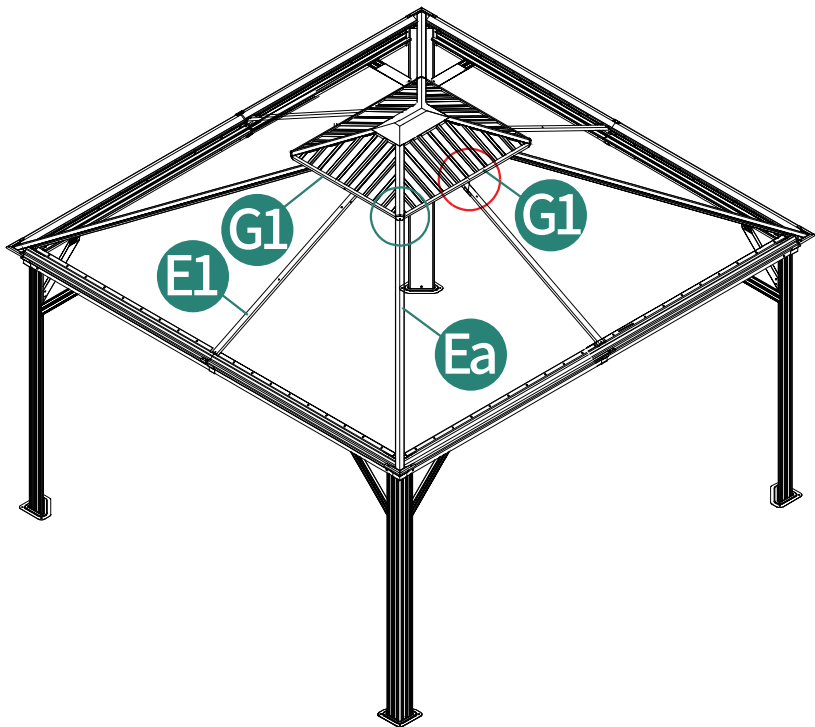
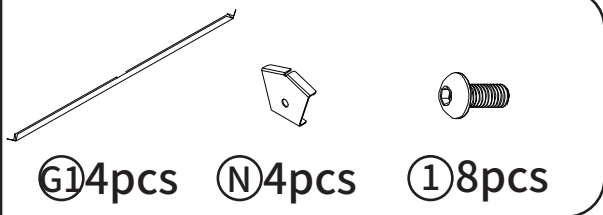

# 14

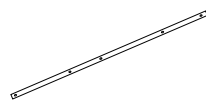

F1 8pcs

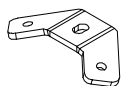

W 4pcs

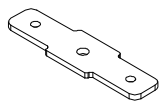

W1 4pcs



1 24pcs

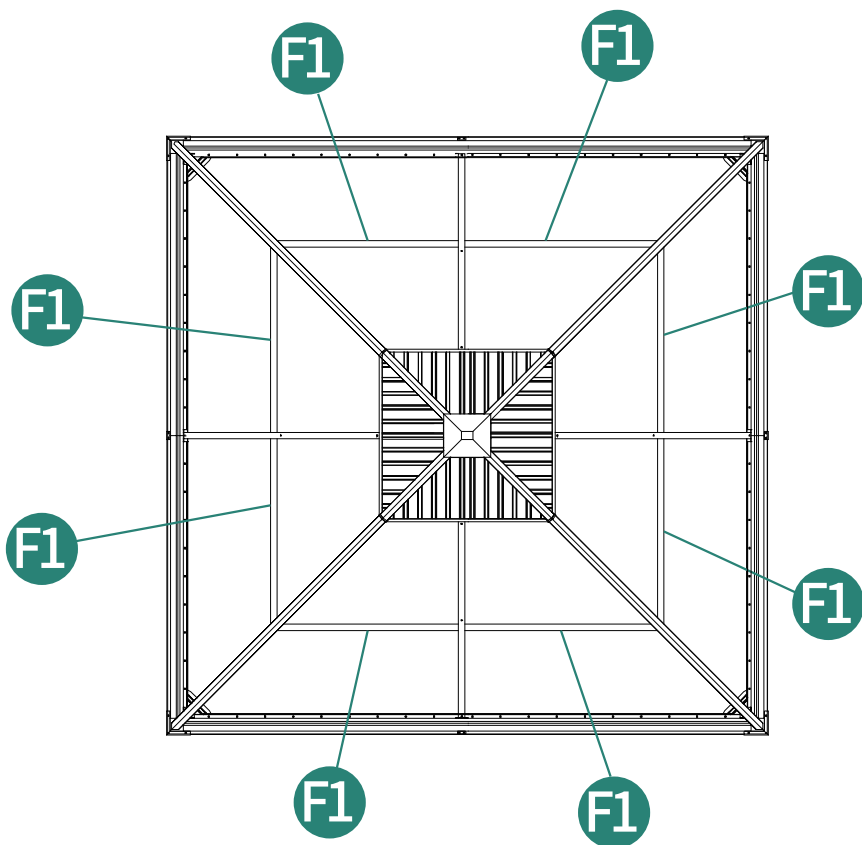
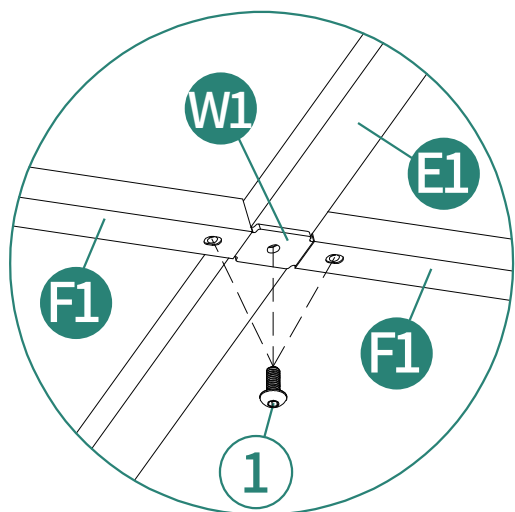
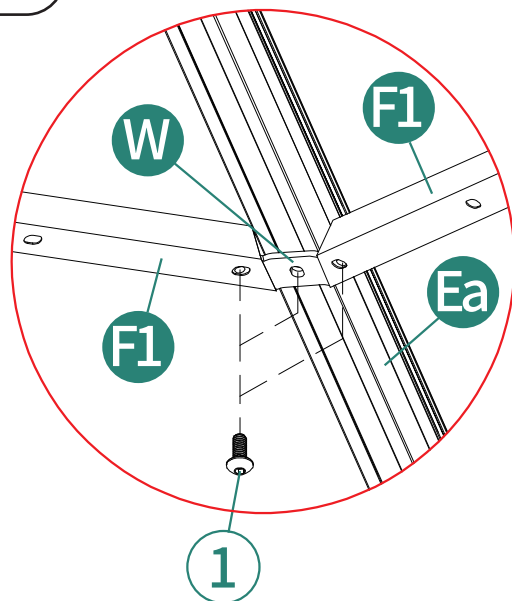
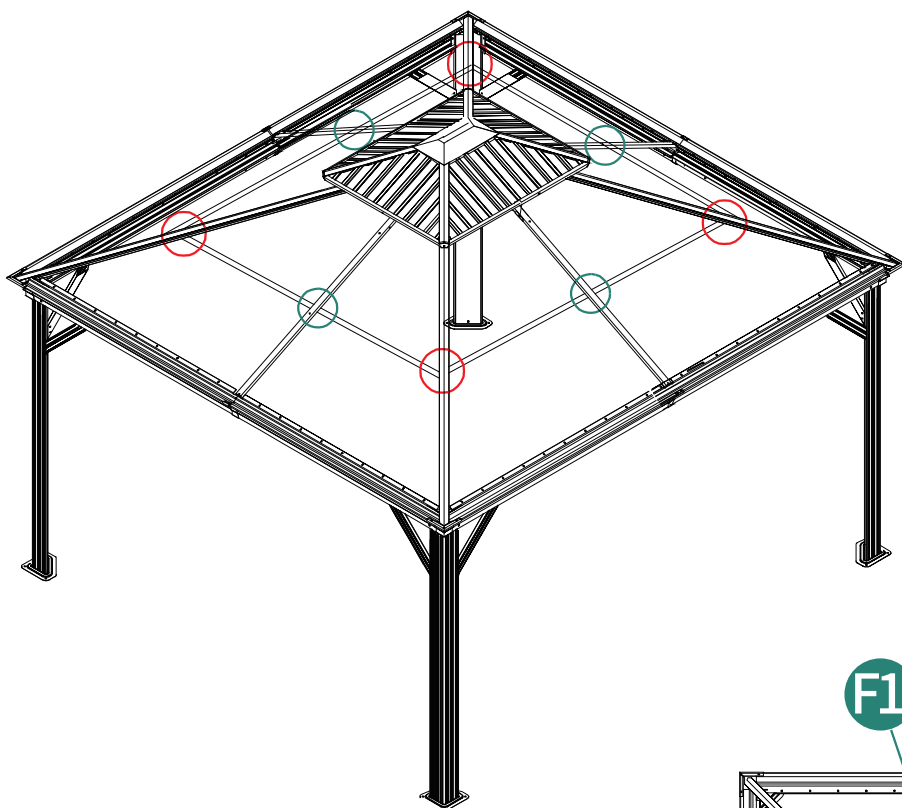

15

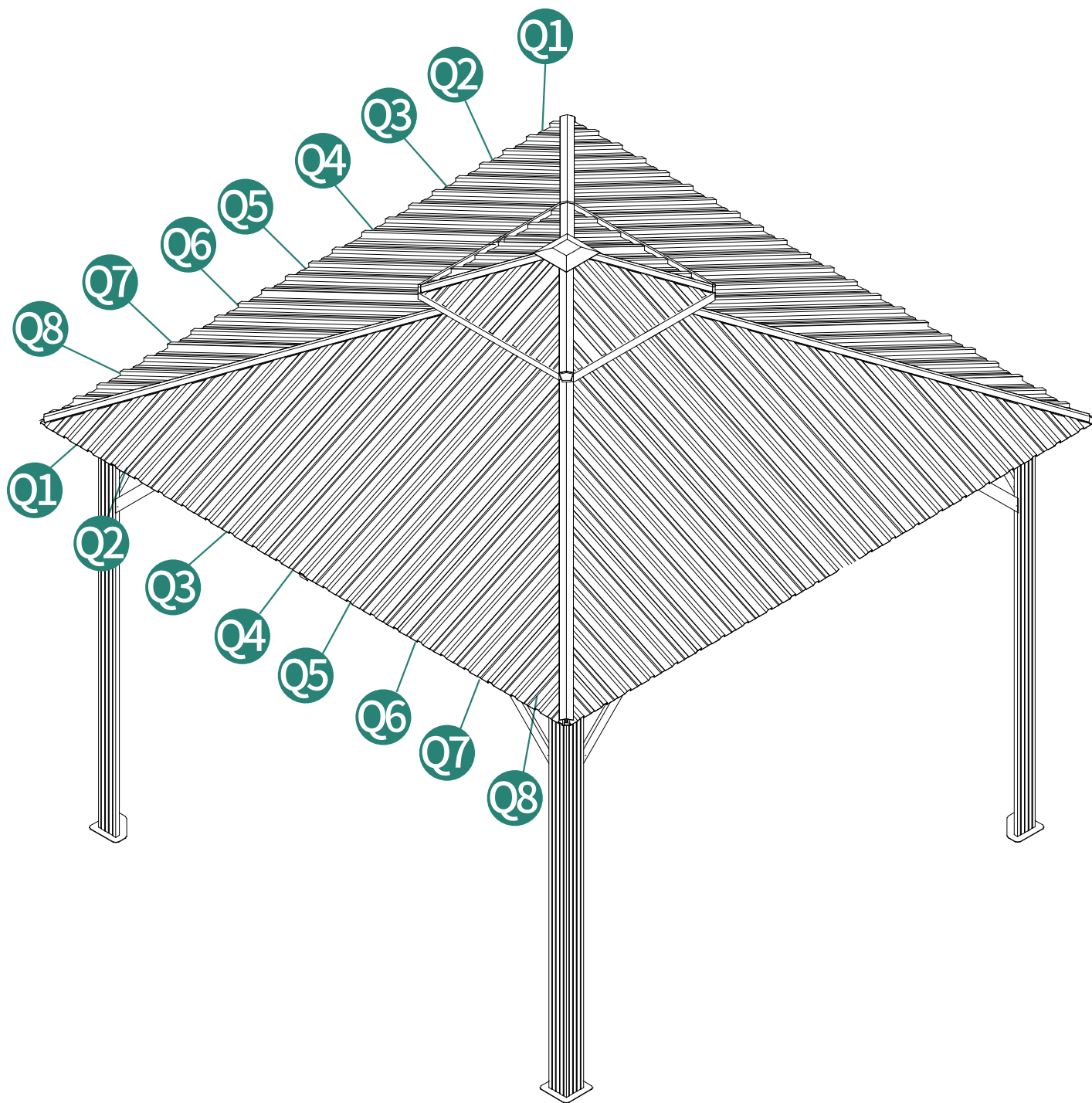

# 16

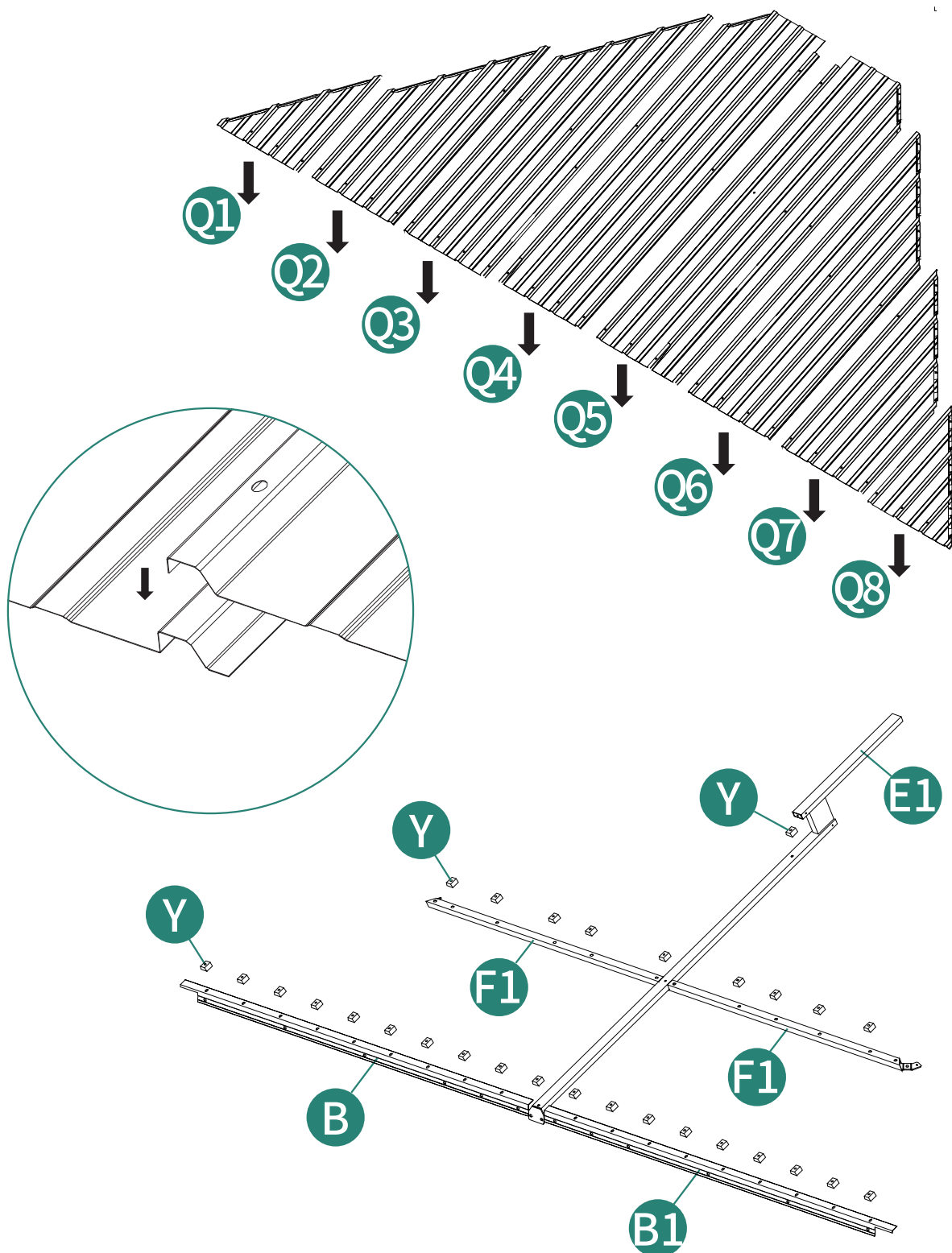

# 17



① 116pcs



② 72pcs



③ 8pcs



⑥ 4pcs



⑦ 32pcs

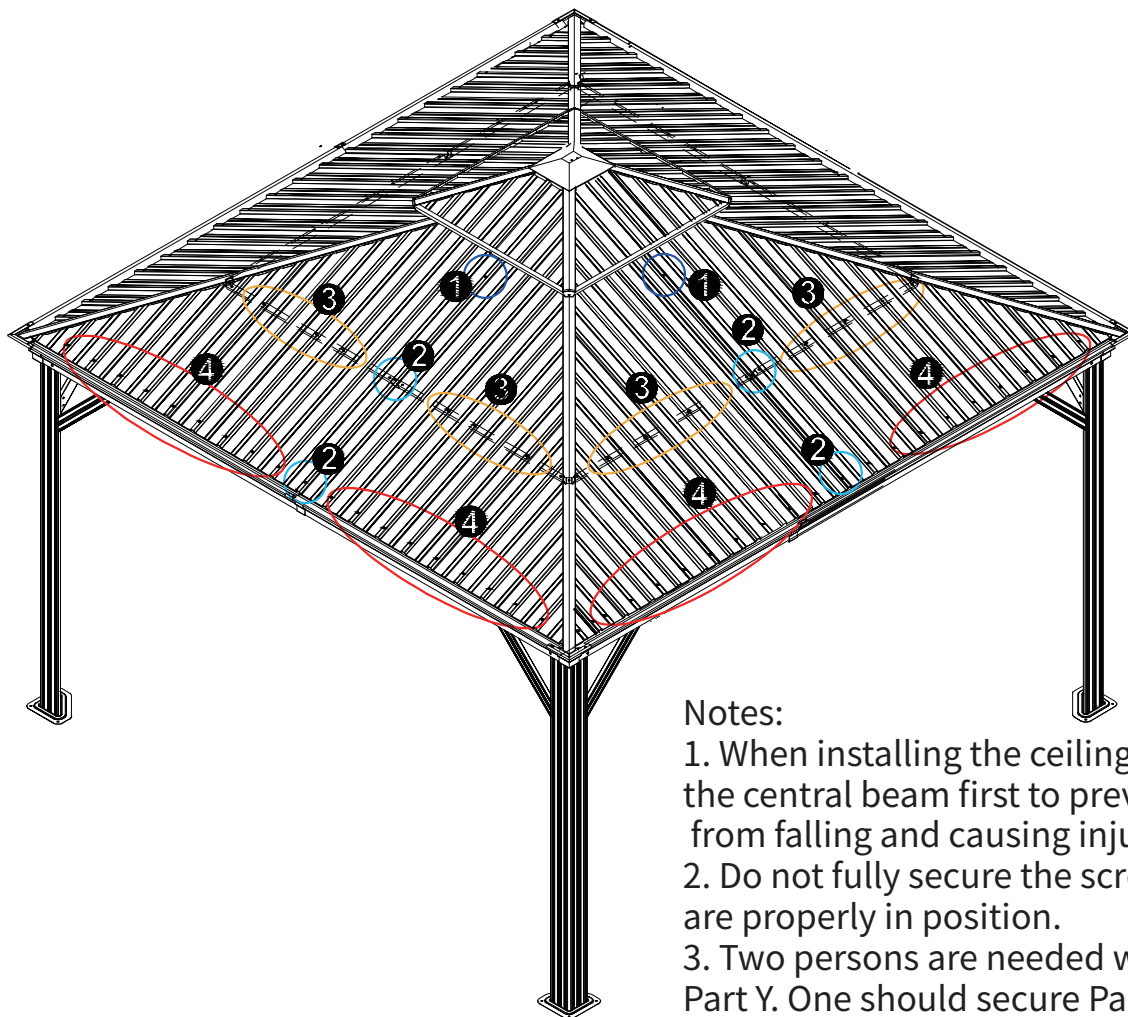

### Notes:

1. When installing the ceiling, fix the screws on the central beam first to prevent the iron sheet from falling and causing injury.
2. Do not fully secure the screw until all screws are properly in position.
3. Two persons are needed when installing Part Y. One should secure Part Y's position from inside the gazebo, while the other inserts screws into Part Y from outside the gazebo.

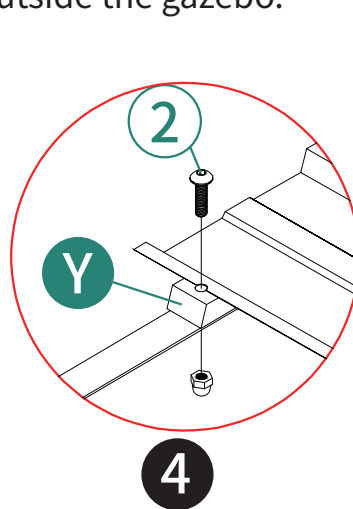
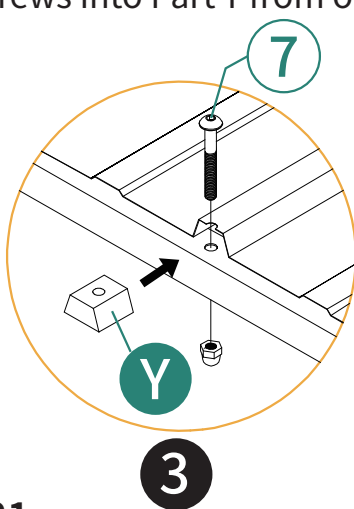
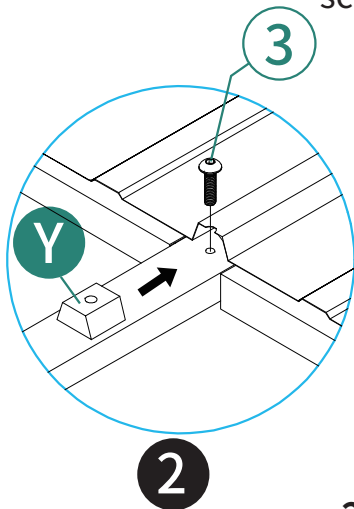
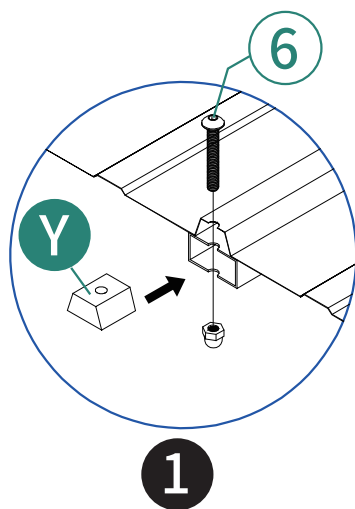

# 18

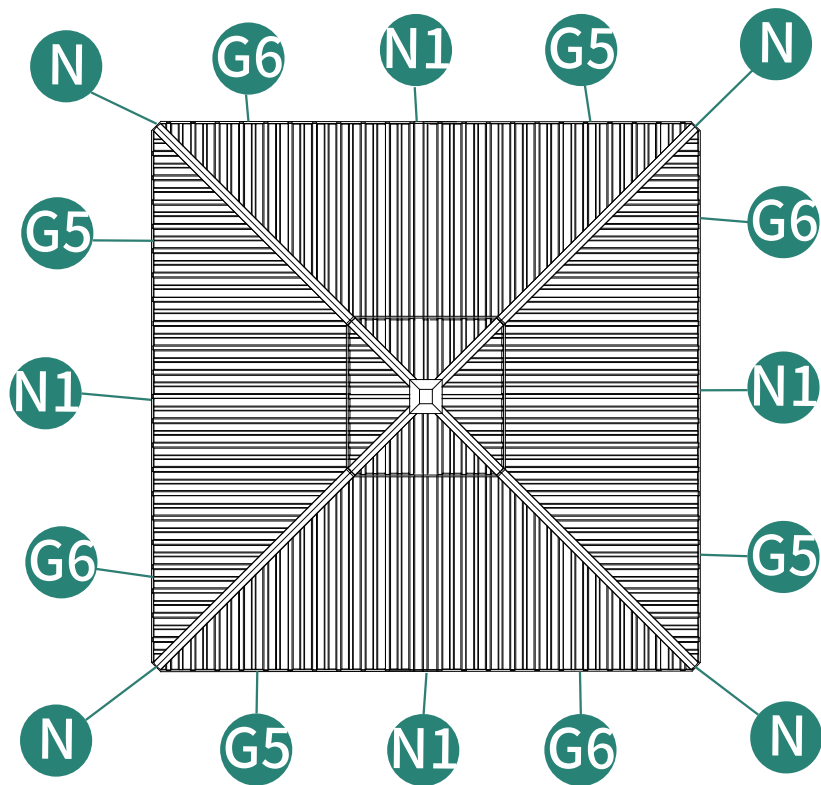
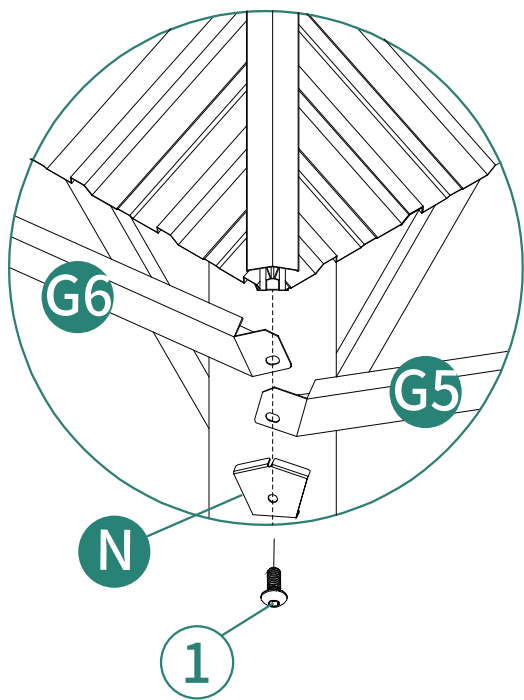
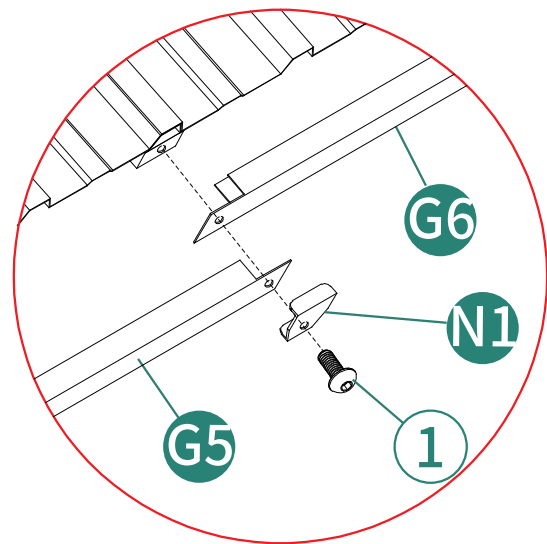
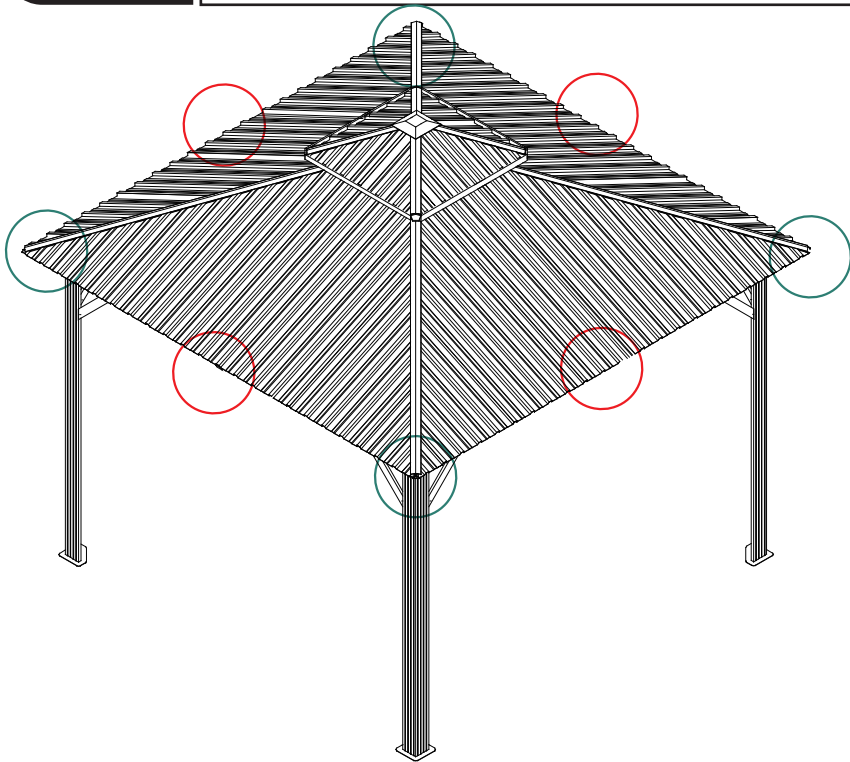
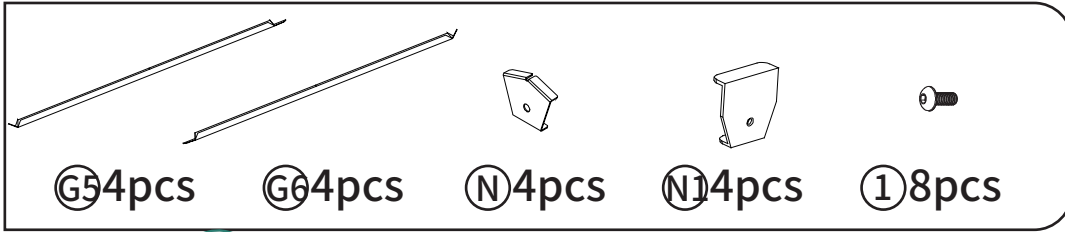

# 19



Ⓣ4pcs

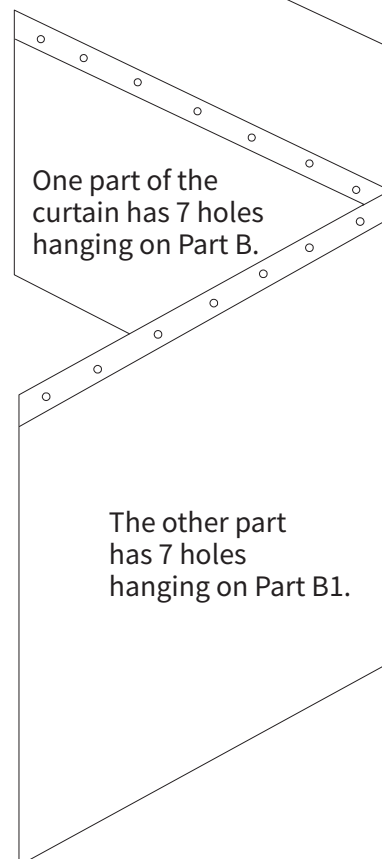
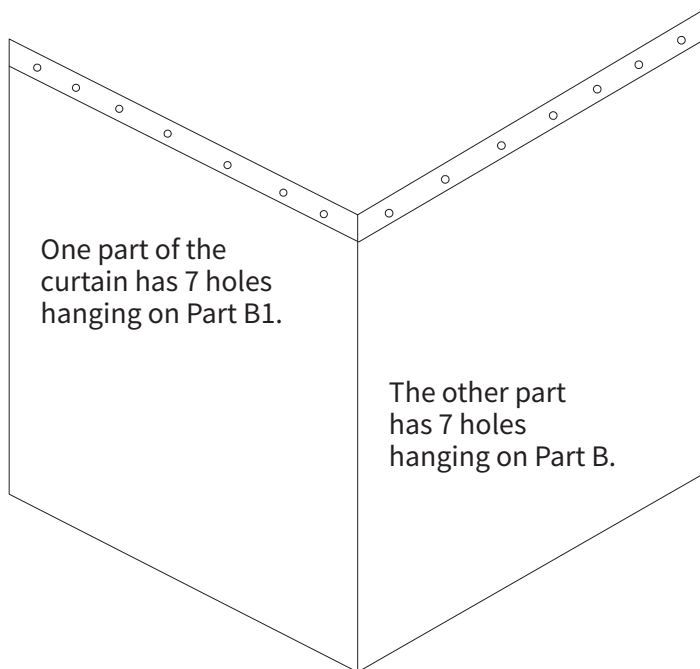
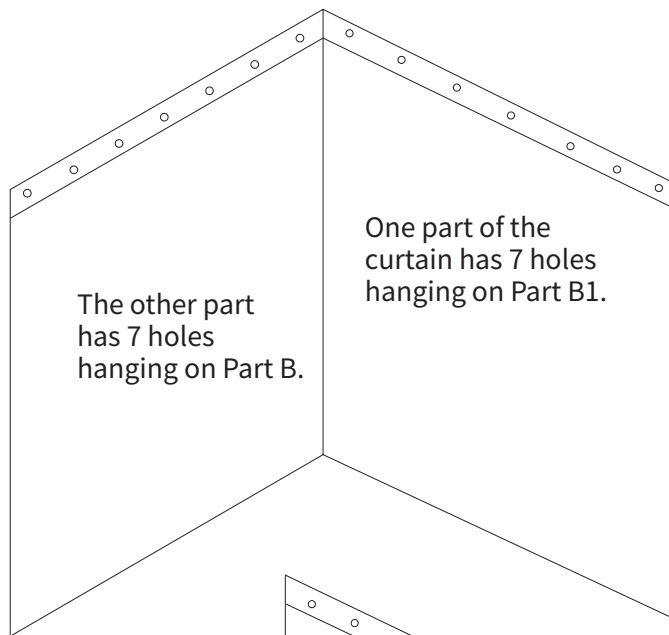
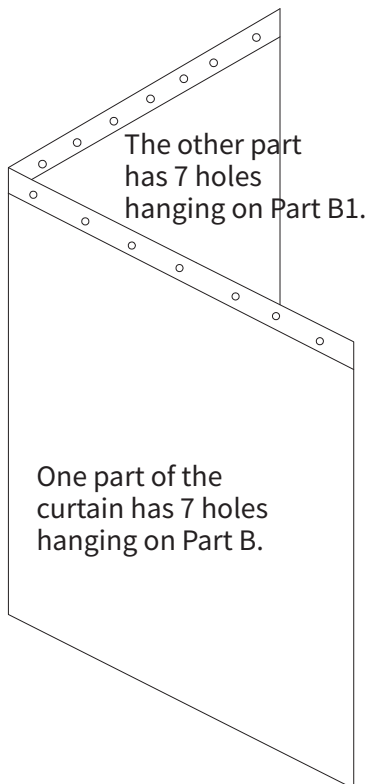

# 20

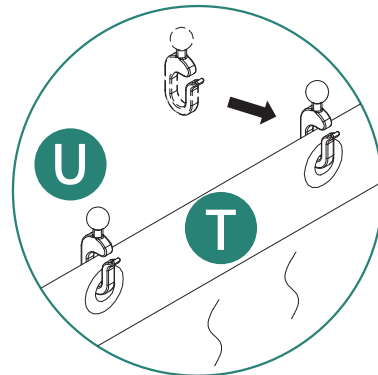
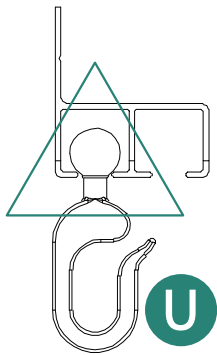
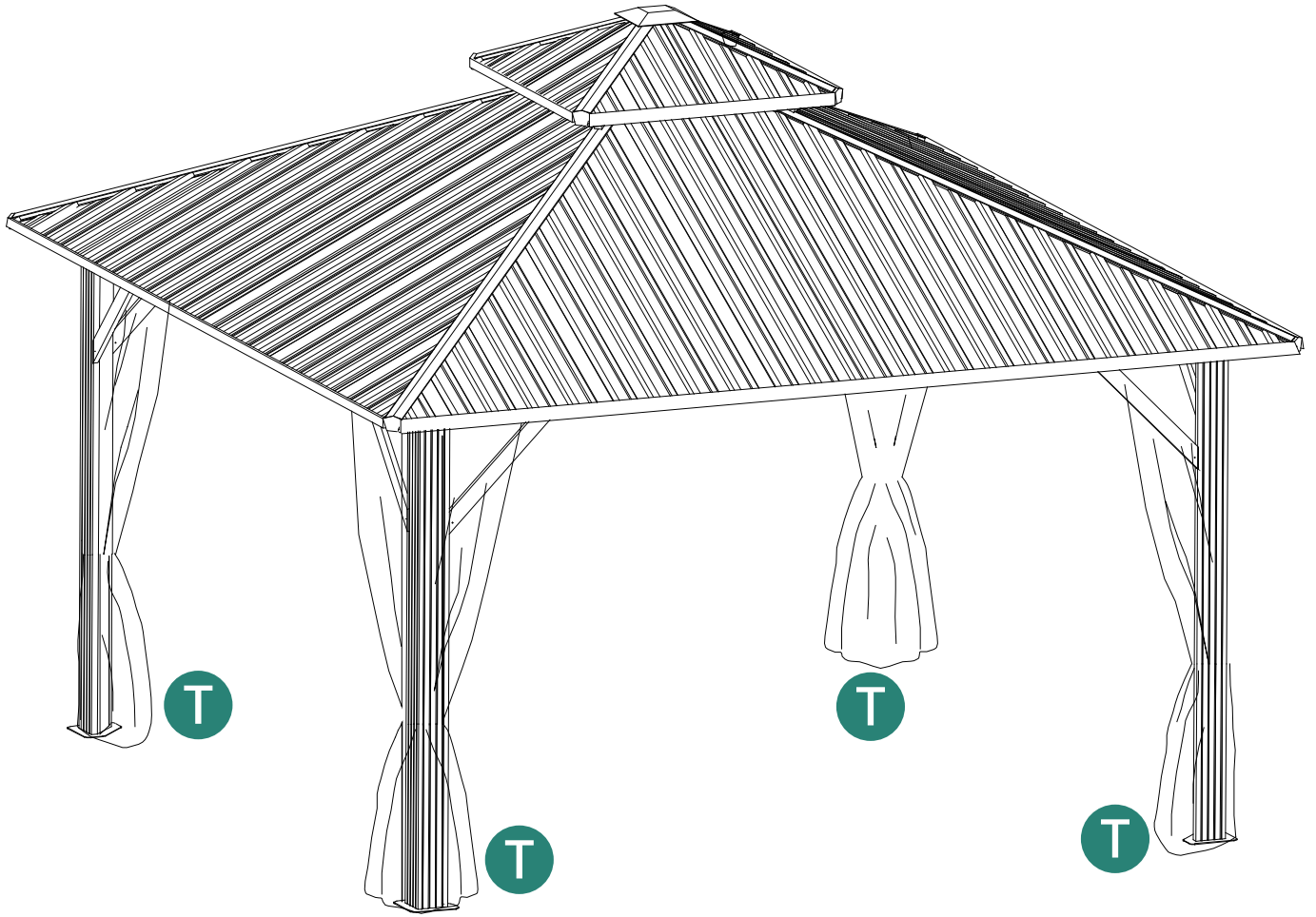

Pay attention to the sidewall curtain's installation position.

# 21

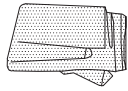

Ⓣ1 4pcs

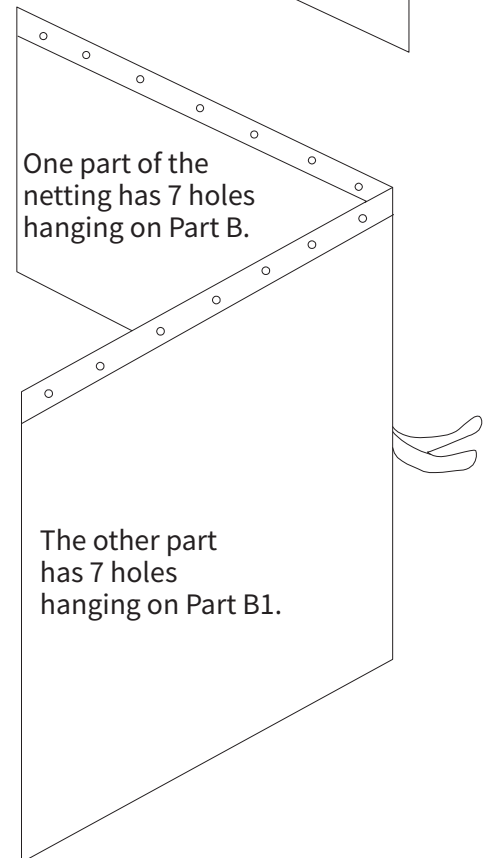
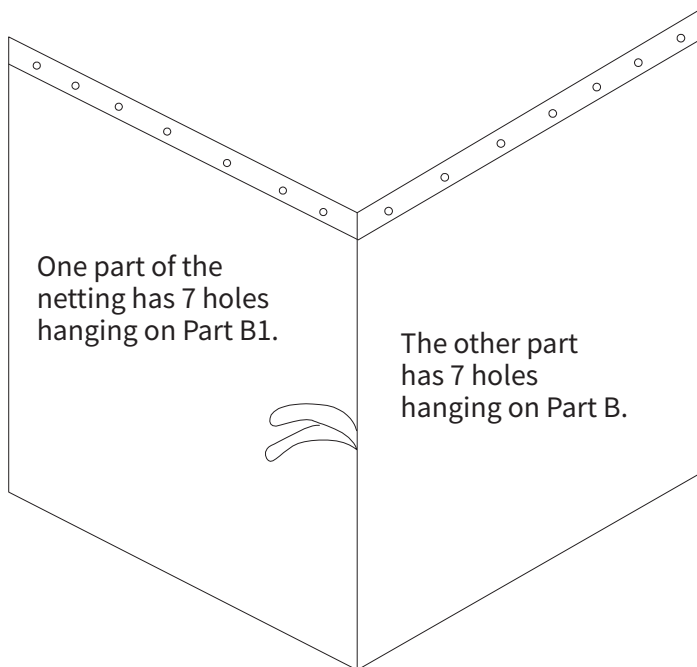
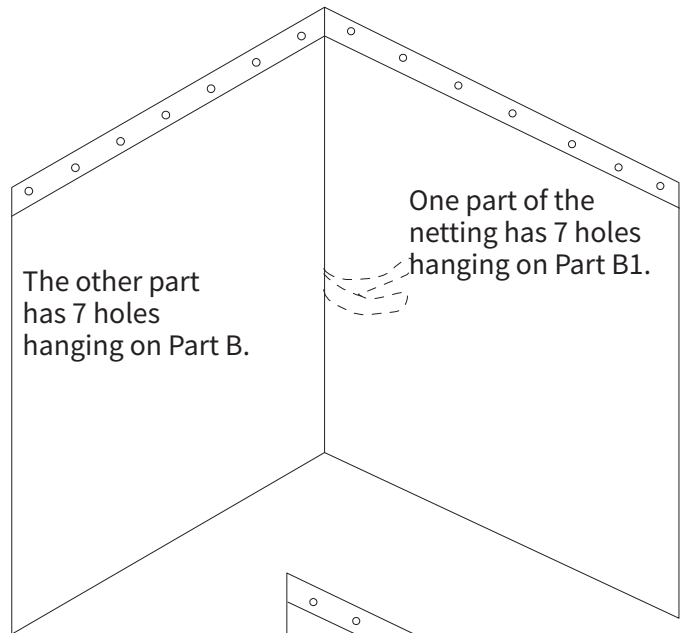
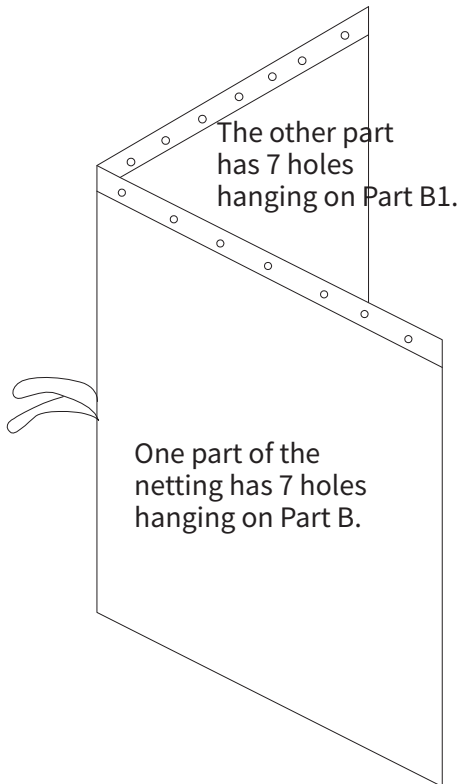

# 22

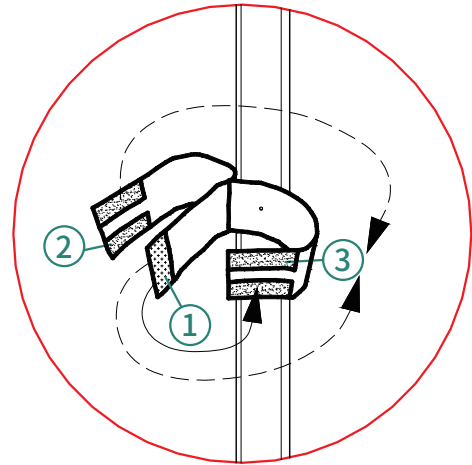
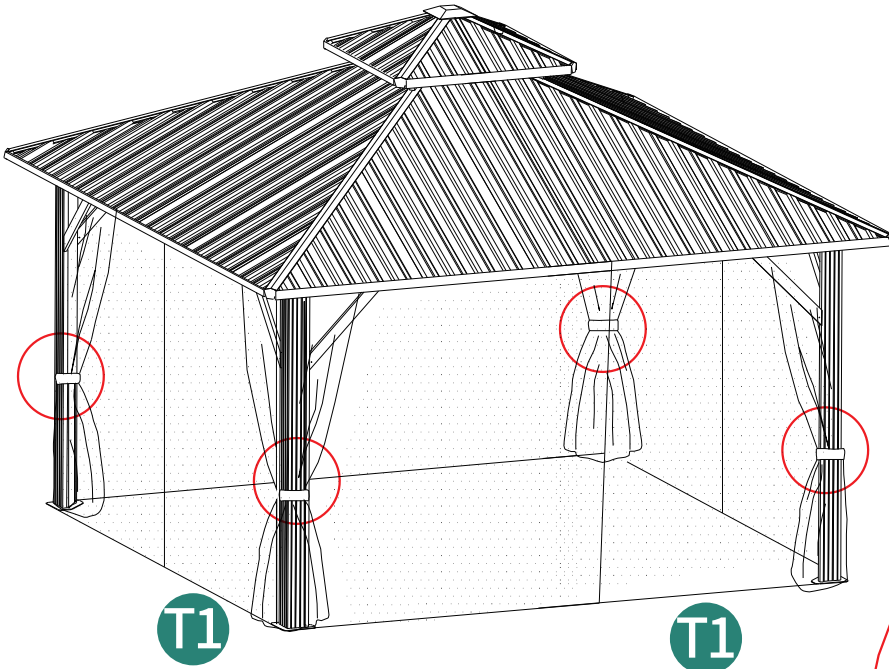

Note:  
Attach 1 to 2 to secure parts T1 and T (curtains) together.  
Attach 1 to 3 to secure the back curtain (T).  
Attach 1 to 3 to secure the front curtain (T1).

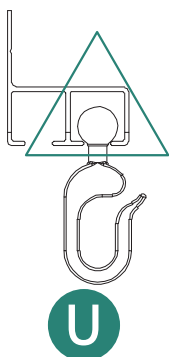

Pay attention to the sidewall netting's installation position.

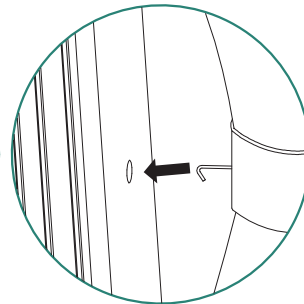
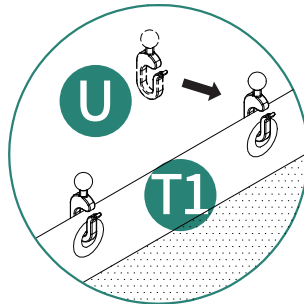

Hang the hook attached to the netting on Part A.

# 23



⑨ 12pcs



⑩ 12pcs

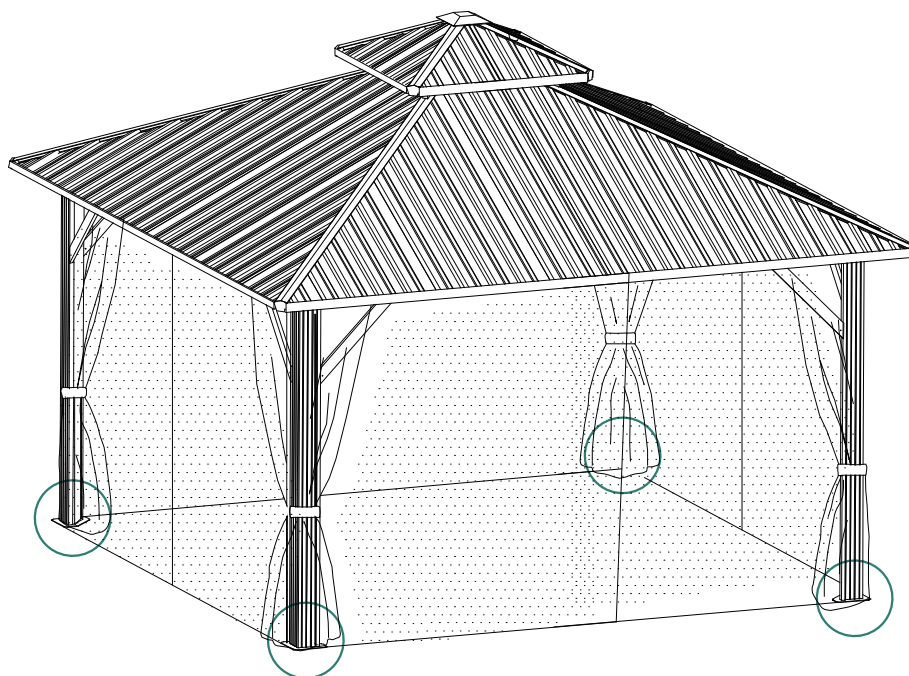

To improve wind resistance, **be sure to complete this installation step. If expansion screws or ground nails are not installed, strong winds may topple the gazebo.**

Expansion screws are essential for stability on cement surfaces, and ground nails are for grassy surfaces. All are included in the accessories package.

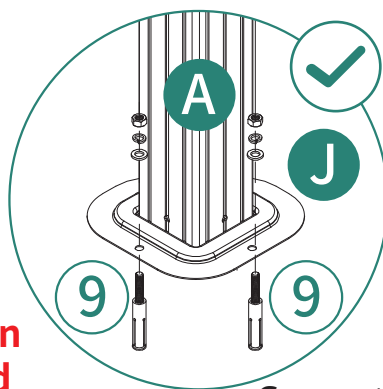

Cement surfaces

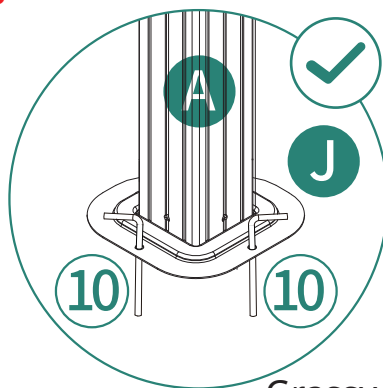
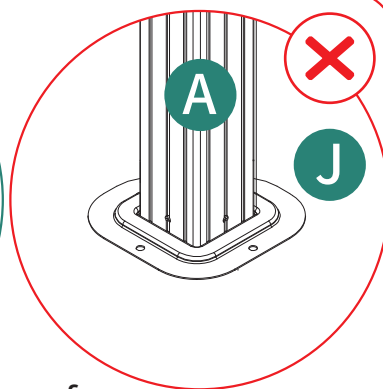

Grassy surfaces

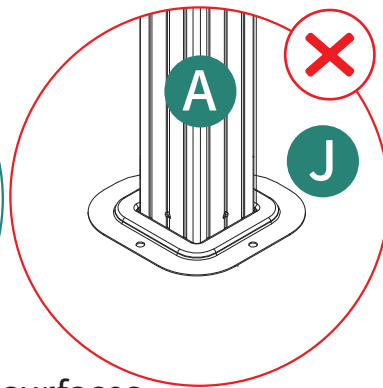

24

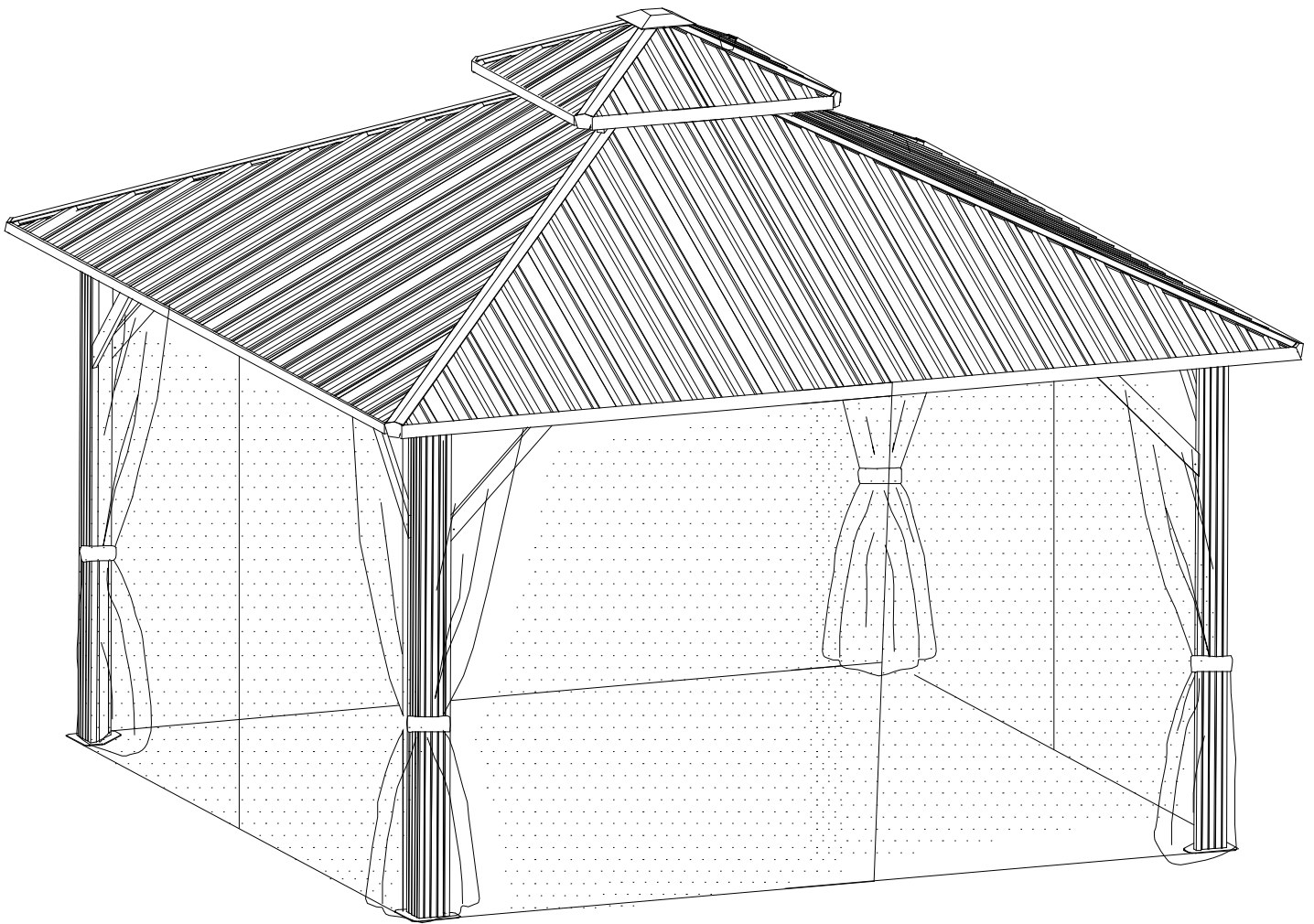

Installation Completed