

YM3117260000111
YM3117260000211

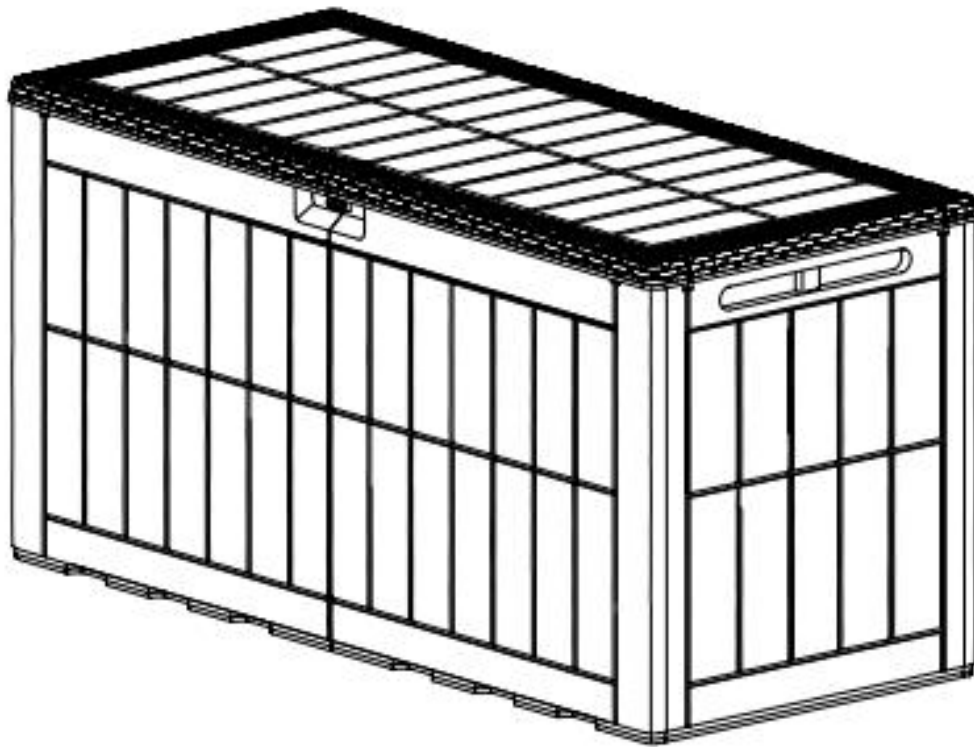

15
STEPS

0.5 HR



EN_IMPORTANT, RETAIN FOR FUTURE REFERENCE: READ CAREFULLY.

**FR_IMPORTANT: A LIRE ATTENTIVEMENT ET À CONSERVER POUR CONSULTATION
ULTÉRIEURE.**

ES_IMPORTANTE, LEA Y GUARDE PARA FUTURAS REFERENCIAS.

PT_IMPORTANTE, RETER PARA REFERÊNCIA FUTURA: LEIA ATENTAMENTE.

DE_WICHTIG! SORFGFÄLTIG LESEN UND FÜR SPÄTERES NACHSCHLAGEN AUFBEWAHREN.

**IT_IMPORTANTE! CONSERVARE IL PRESENTE MANUALE PER FUTURO RIFERIMENTO E
LEggerlo ATTENTAMENTE.**

A2 x 1

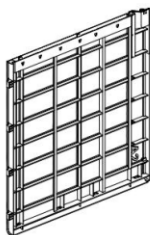

A1 x 1

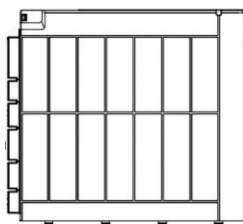

B1 x 1

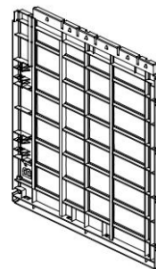

B2 x 1

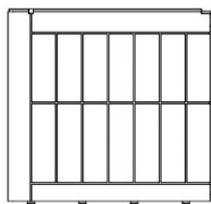

B3 x 4



C x 2



D x 2

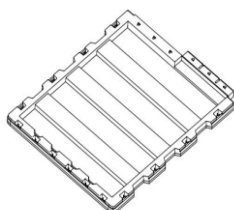

E2 x 1

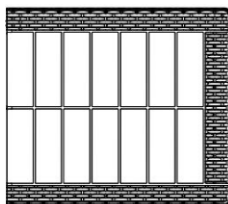

E1 x 1

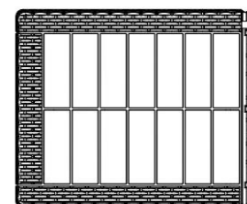

F x 2

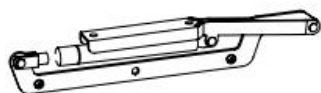

G x 14
M4*16
+2(spare)

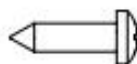

H x 3

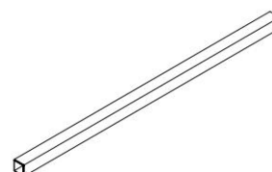

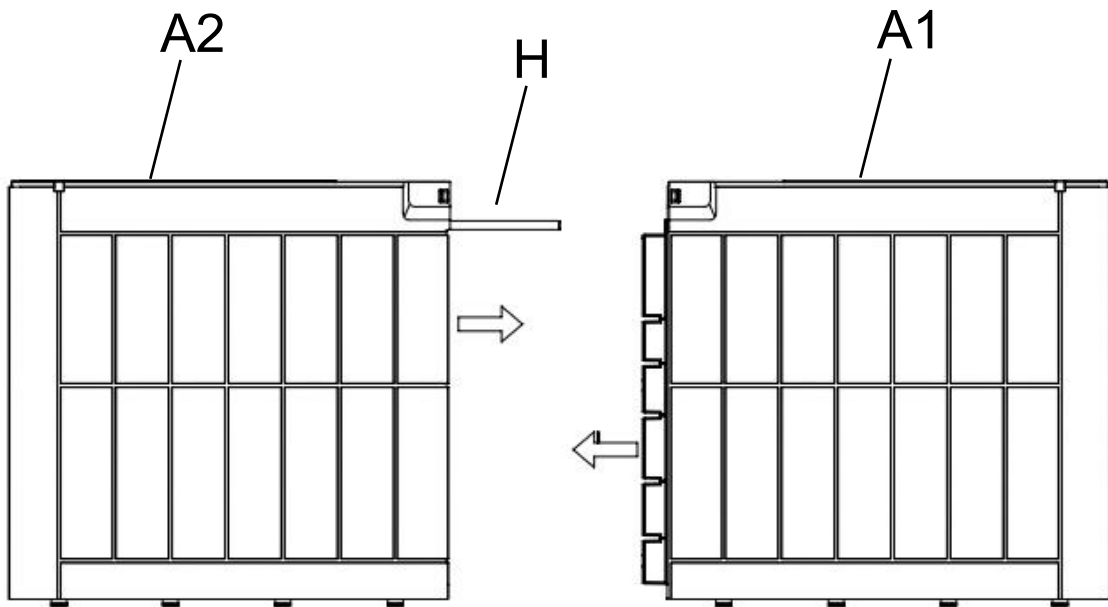
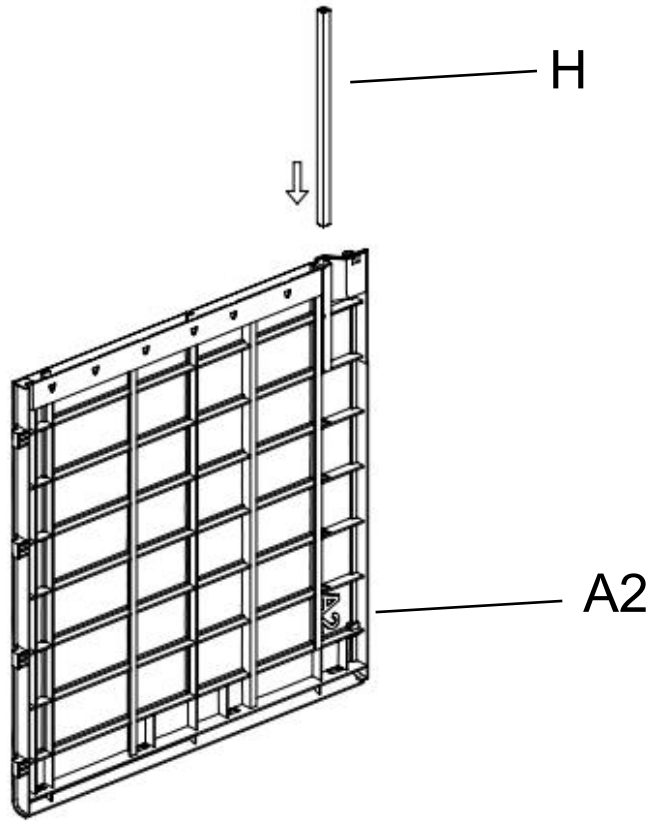

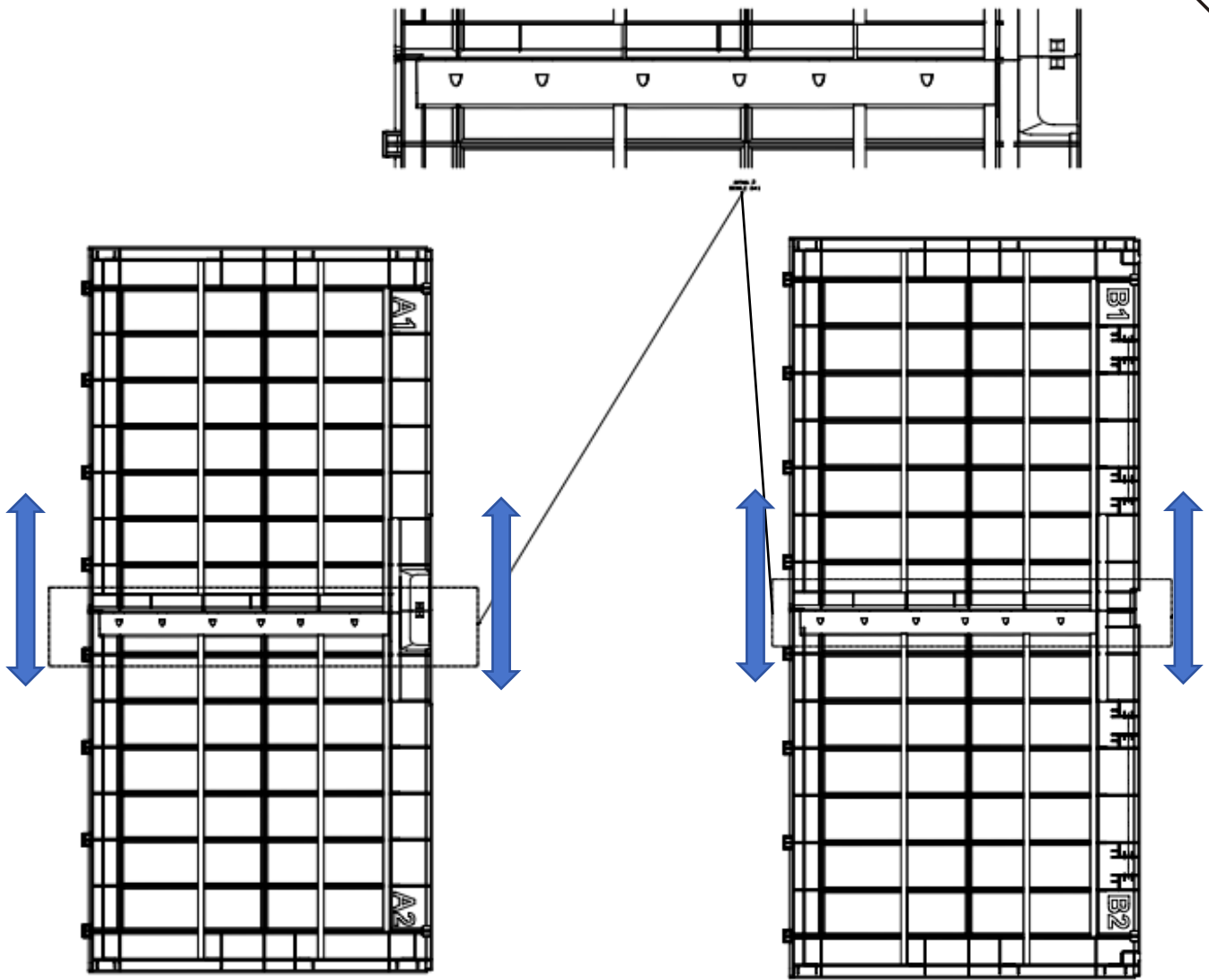

EN_ Stand panels A1/B1 and A2/B2 upright. Hold panel A1/B1 and gently tap it against the floor (which has been covered with cardboard) to ensure all clips/snaps are fully engaged/locked in place.

FR_ Placez les panneaux A1/B1 et A2/B2 à la verticale. Tenez le panneau A1/B1 et tapotez-le doucement contre le sol (recouvert de carton) pour vous assurer que tous les clips/boutons-pression sont bien enclenchés/verrouillés.

ES_ Coloque los paneles A1/B1 y A2/B2 en posición vertical. Sujete el panel A1/B1 y golpéelo suavemente contra el suelo (que habrá cubierto con cartón) para asegurarse de que todos los clips/broches estén completamente encajados/bloqueados en su sitio.

DE_ Stellen Sie die Standplatten A1/B1 und A2/B2 aufrecht hin. Halten Sie die Platte A1/B1 fest und klopfen Sie sie vorsichtig gegen den Boden (der mit Pappe ausgelegt wurde), um sicherzustellen, dass alle Clips/Schnapper vollständig eingerastet/verriegelt sind.

IT_ Posizionare i pannelli A1/B1 e A2/B2 in posizione verticale. Tenere il pannello A1/B1 e picchiettarlo delicatamente sul pavimento (che è stato ricoperto con del cartone) per assicurarsi che tutti i fermagli/ganci siano completamente agganciati/bloccati in posizione.

PL_ Ustaw panele A1/B1 i A2/B2 w pozycji pionowej. Przytrzymaj panel A1/B1 i delikatnie uderzaj nim o podłogę (pokrytą tekturą), aby upewnić się, że wszystkie zatrzaski/zatrzaski są całkowicie zablokowane/zabezpieczone.

RO_ Așezați panourile A1/B1 și A2/B2 în poziție verticală. Țineți panoul A1/B1 și loviți-l ușor de podea (acoperită cu carton) pentru a vă asigura că toate clemele/capse sunt complet fixate/blocate în poziție.

