

ASSEMBLY INSTRUCTION

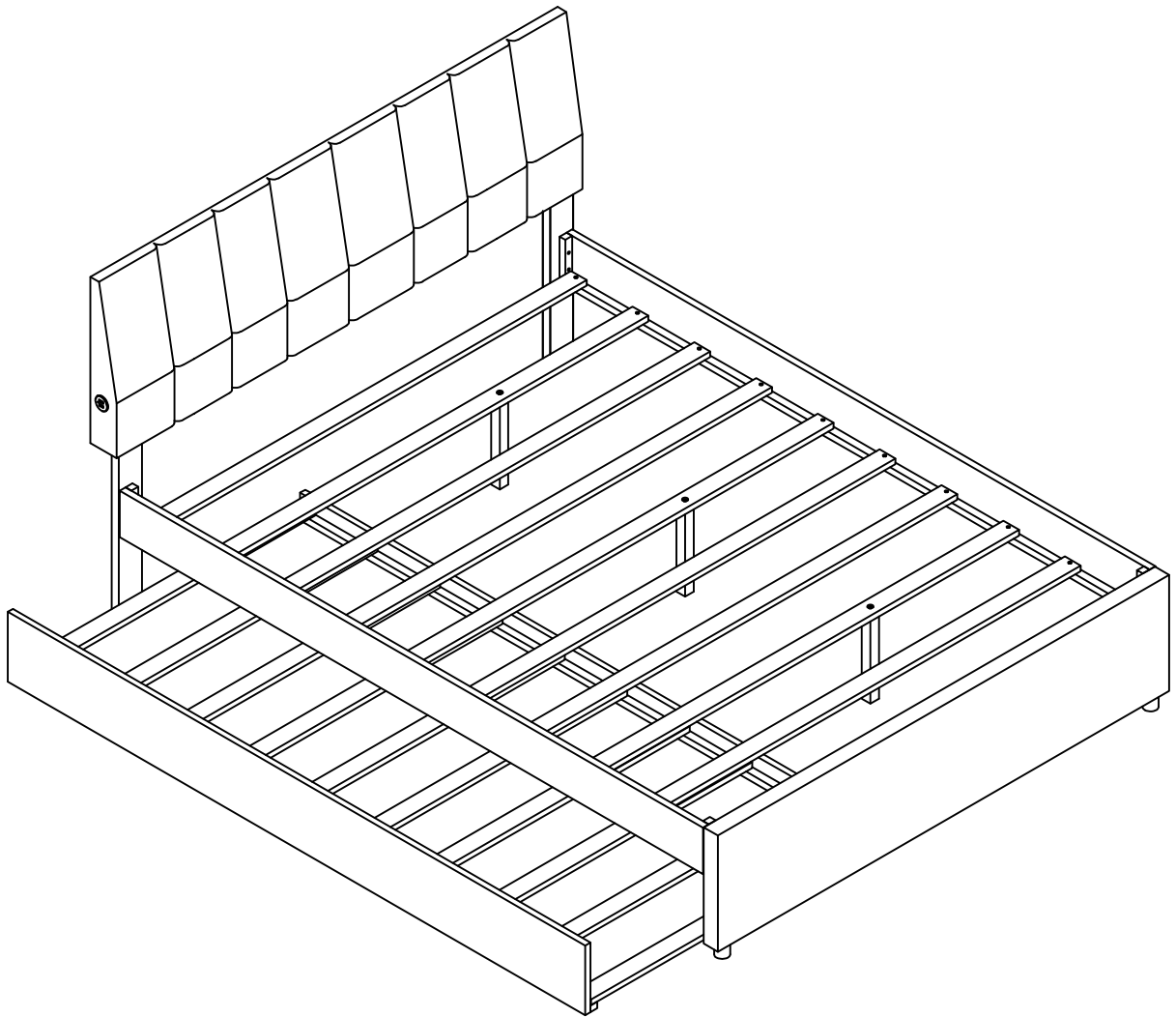

ASSEMBLY INSTRUCTION

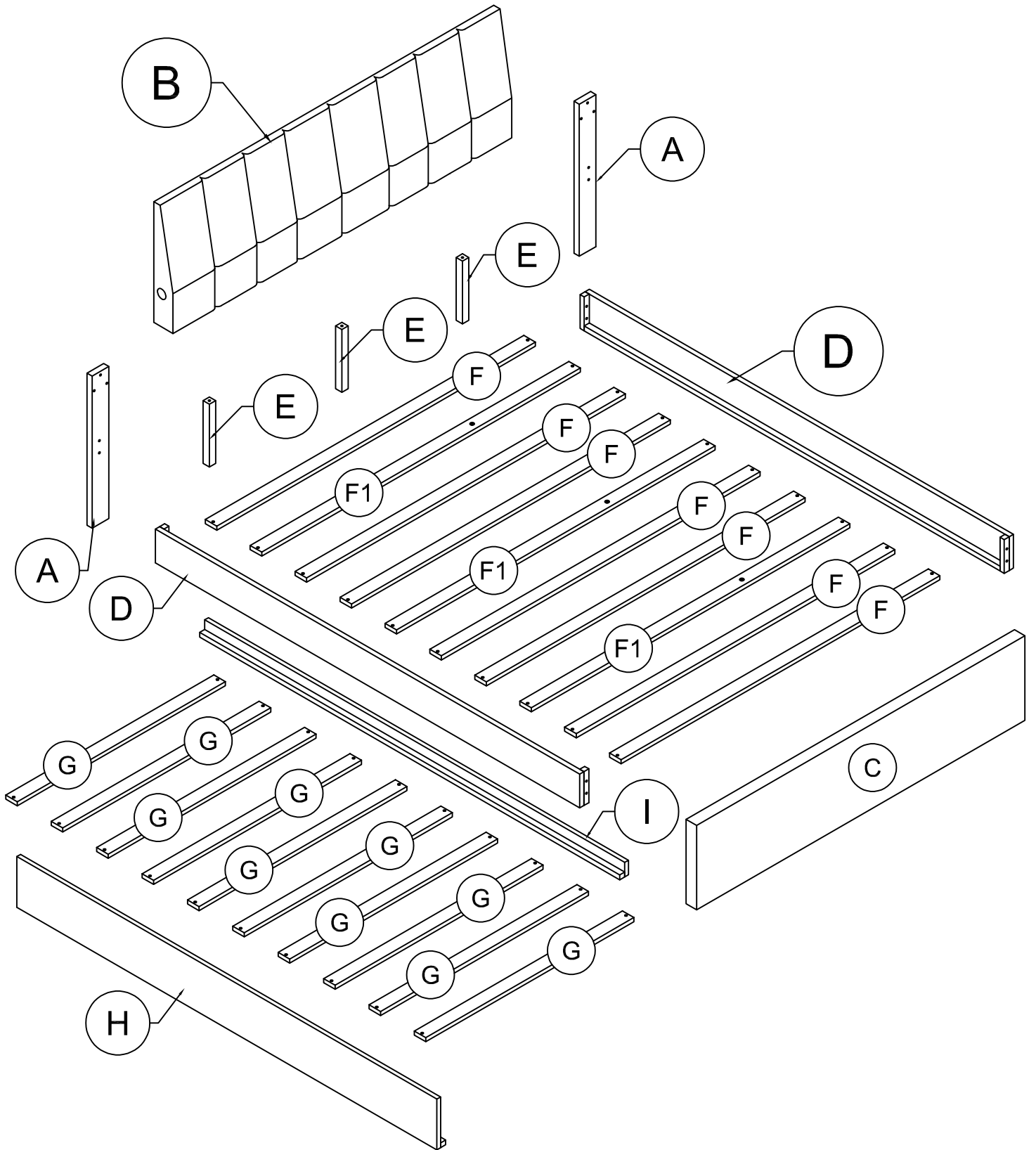

Part List

A

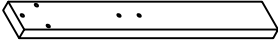

Leg (HB Font) - 2pcs

B

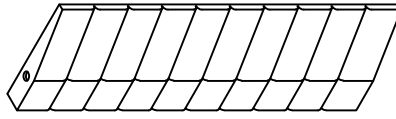

HB Frames - 1pcs

C

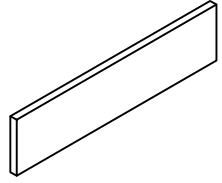

FB Frames - 1pcs

E

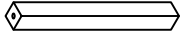

Support Leg - 3pcs

F

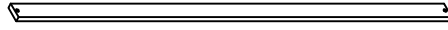





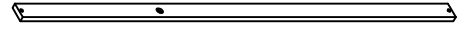

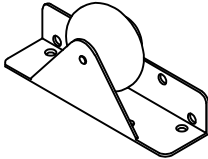
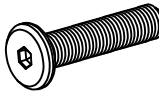

Slats - 7pcs

F1

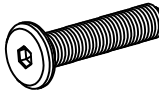
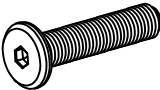

Slats - 3pcs

Hardware List

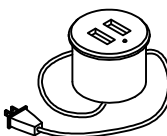
<p>1</p>  <p>Wheels 4pcs</p>	<p>2</p>  <p>1/4" x 40mm Hex-Head bolts 6pcs</p>	<p>3</p>  <p>Allen Key 1pcs</p>
<p>4</p>  <p>Plastic Feet(Ø50x40) 2pcs</p>	<p>5</p>  <p>Steel Bracket 3pcs</p>	<p>6</p>  <p>Plastic Drawer Stopper 4 pcs</p>
<p>7</p>  <p>M4 x 15 mm Wood Screws 24pcs</p>	<p>8</p>  <p>1/4" x 30mm Hex-Head bolts 3pcs</p>	<p>9</p>  <p>1/4" x 50mm Hex-Head bolts 8pcs</p>
<p>10</p>  <p>M4 x 30 mm Wood Screws 40pcs</p>	<p>11</p>  <p>USB Power Socket 1pcs</p>	

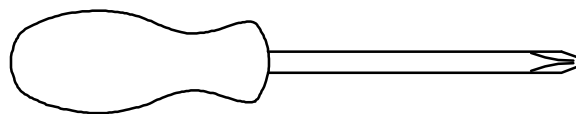

Assembly Tools Required (Not Included)

Part List

D

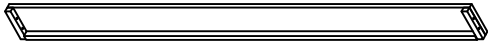

Side Rails - 2pcs

G

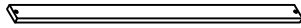

Slats - 10pcs

H



Font Trundle - 1pcs

I

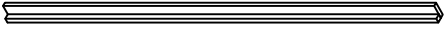

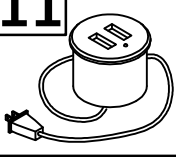
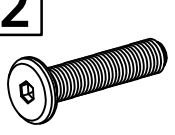
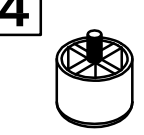

Back Trunlde - 1pcs

STEP 1: Following below illustration:

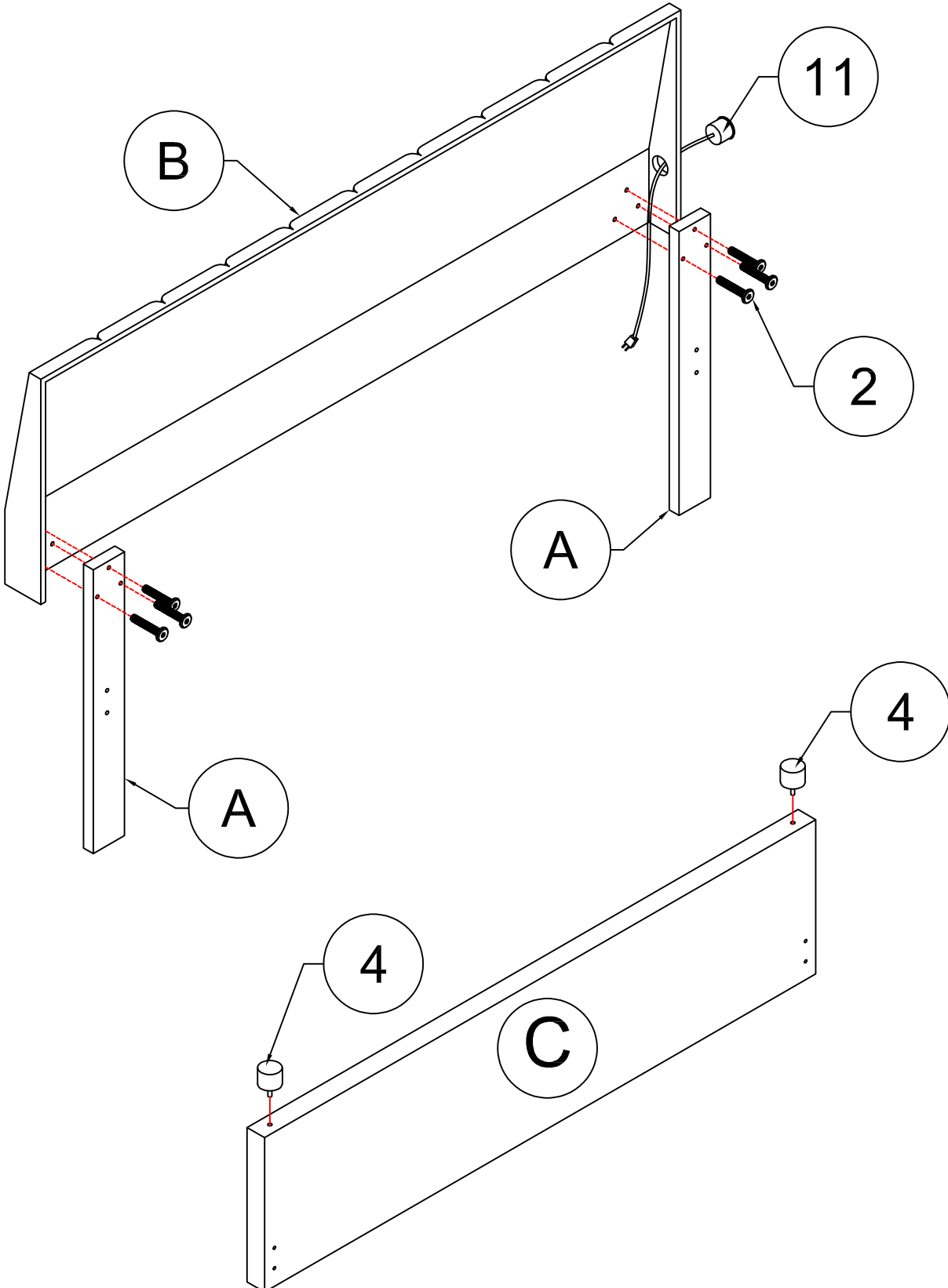
11 	2 	4 
1pcs	6pcs	2pcs



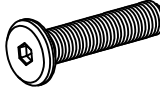

STEP 2: Following below illustration:

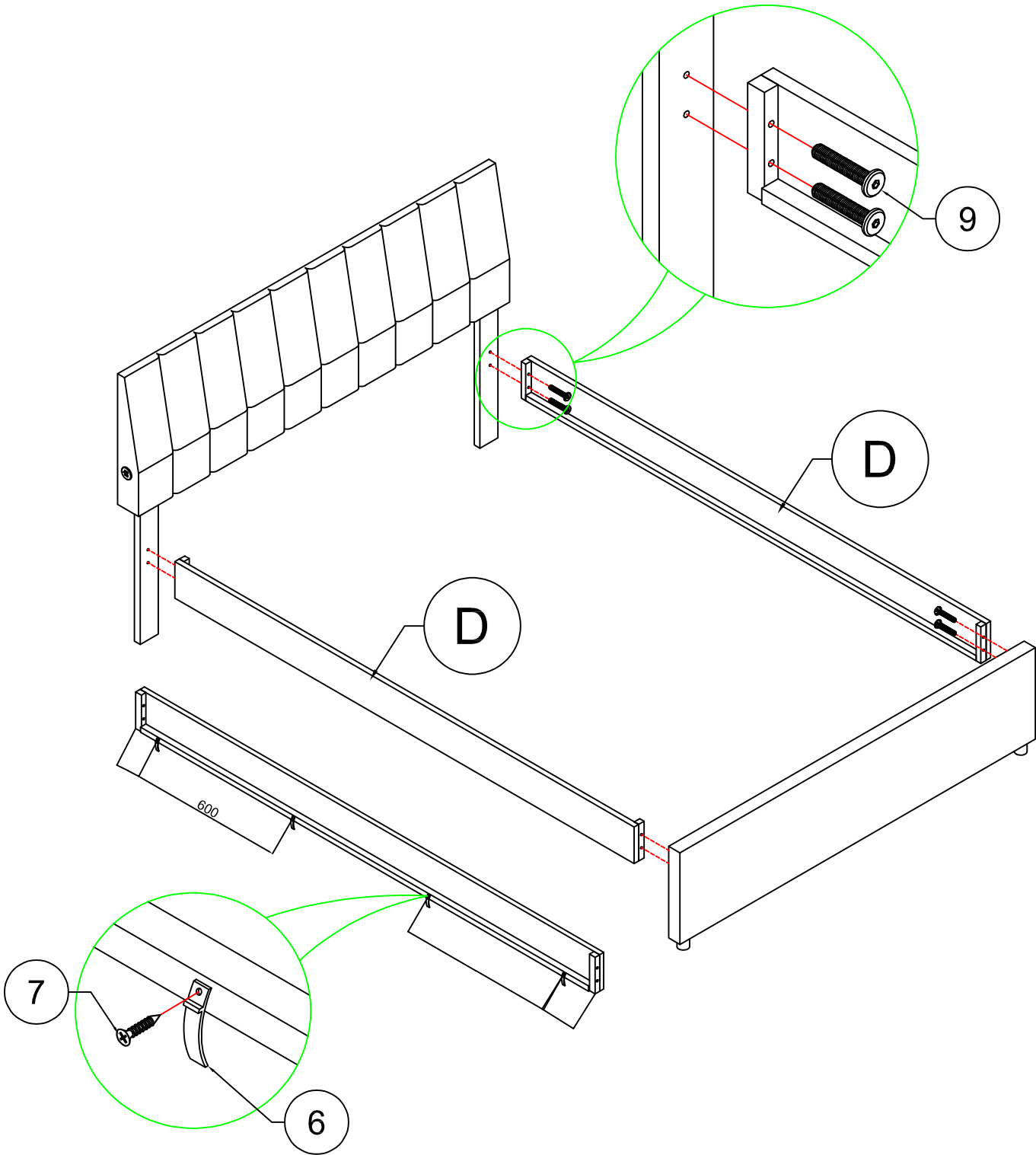
6		7		9	
4pcs		4pcs		8pcs	

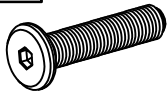

STEP 3: Following below illustration:

8	10
	
3pcs	20pcs

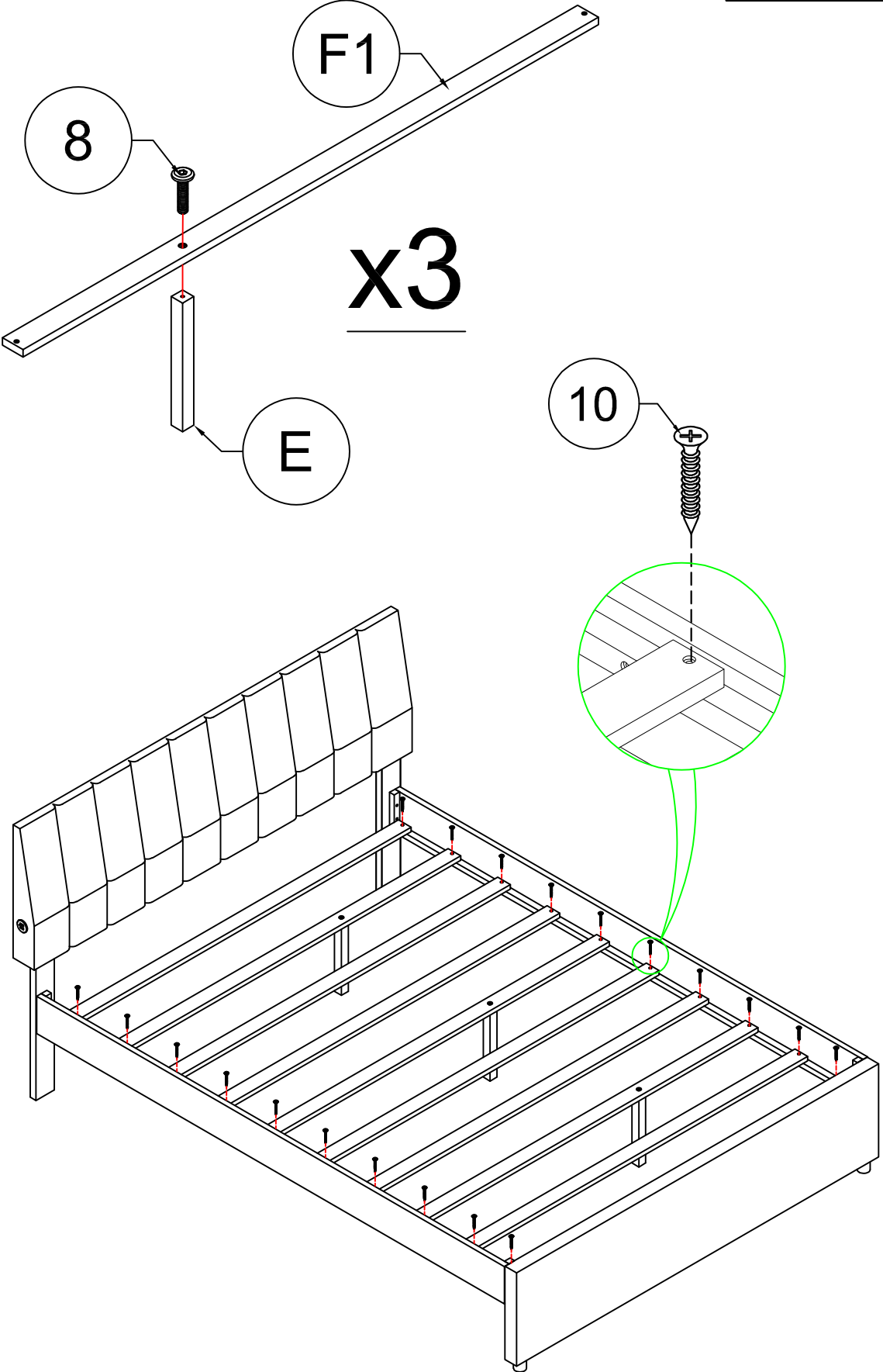

STEP 4: Following below illustration:

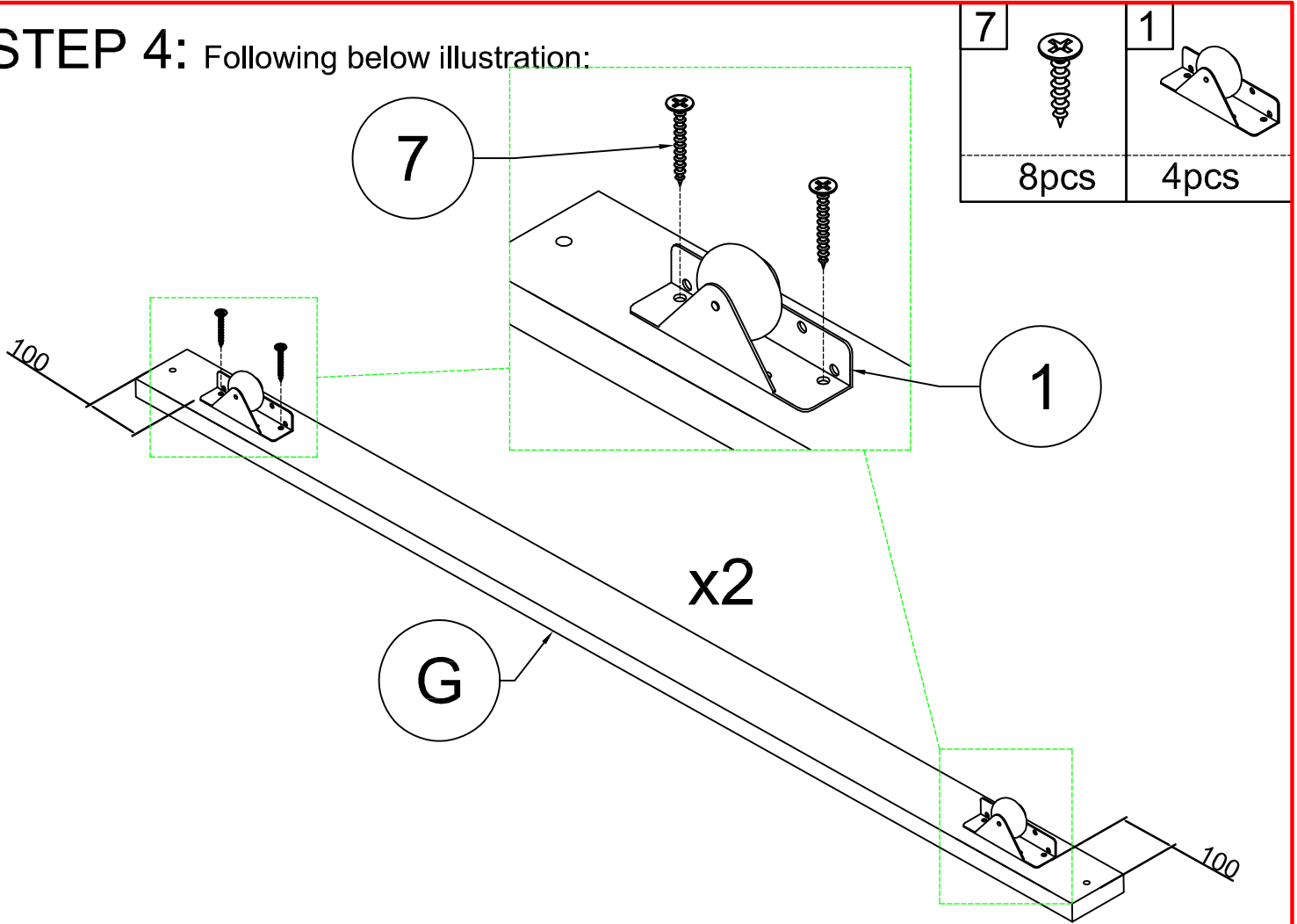

STEP 4-1: Following below illustration:

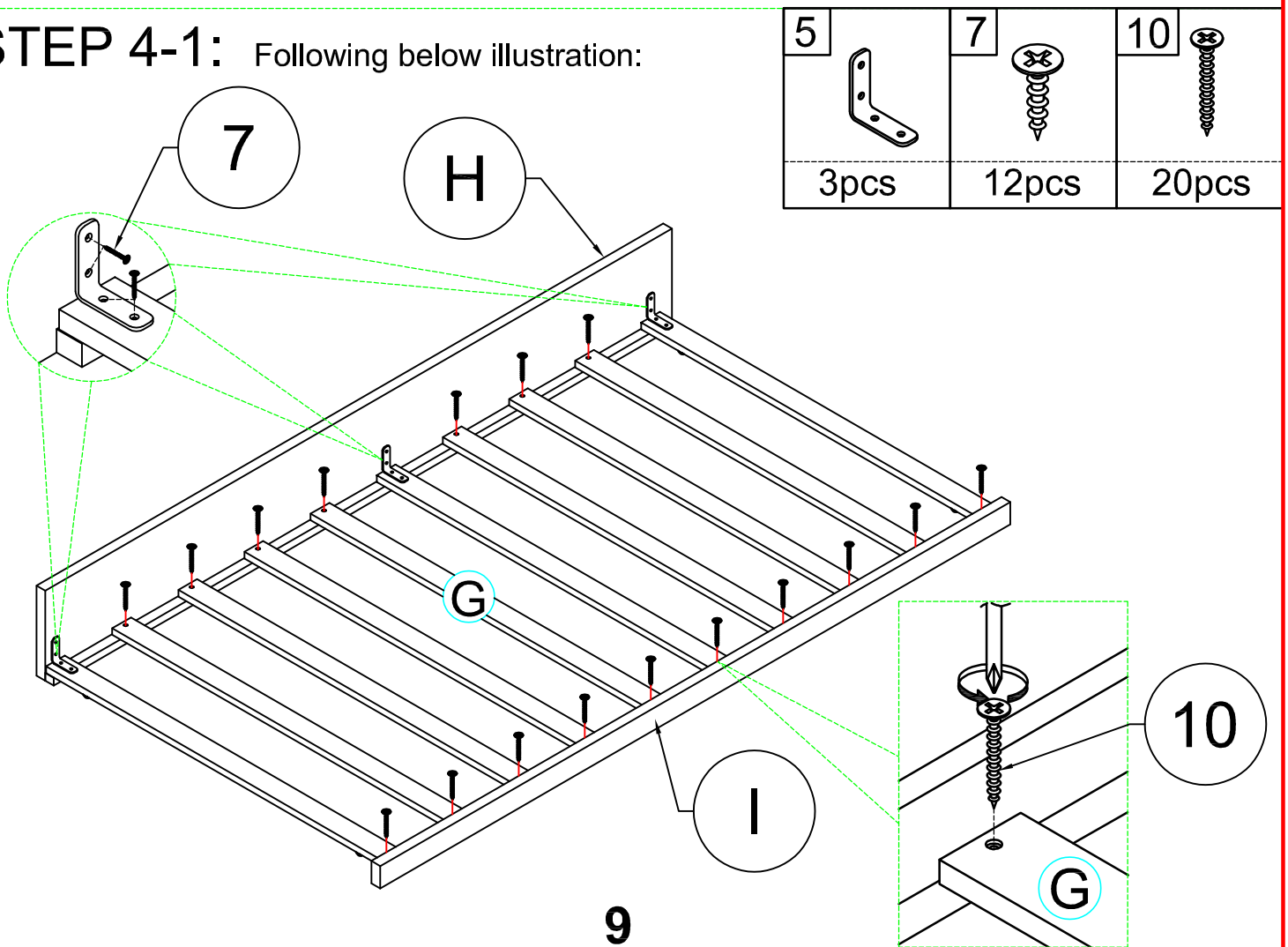

FINISH

