

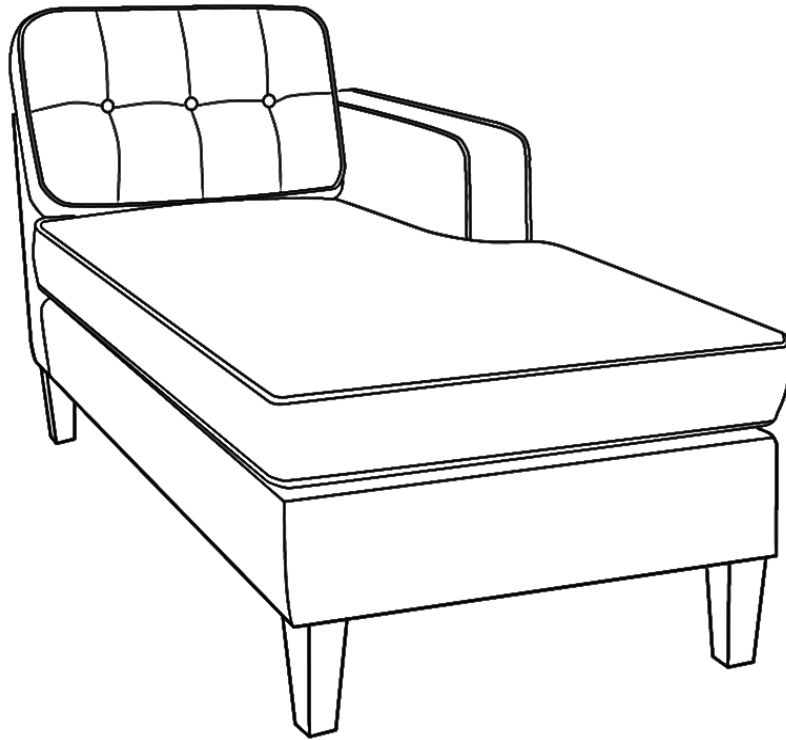

Assembly Instructions

Caution : You must read this before you proceed

RIGHT ARM SOFA



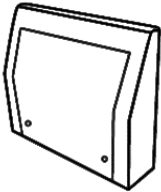
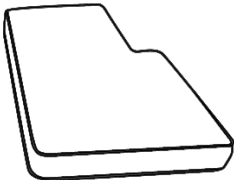

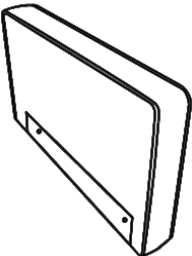
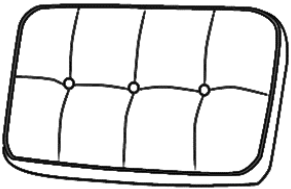



Parts List

Label	Picture	Description	QTY
A		Backrest	1
B		Seat Cushion	1
C		Chaise Seat Frame	1
D		Right Arm	1
E		Back Cushion	1

F		Leg	5
---	---	-----	---





Hardware

Label	Picture	Description	QTY
①		Bolt(M8*60MM)	5
②		Bolt(M8*20MM)	2
③		Washer	6
④		Allen Key	1
⑤		Washer Ring	6
⑥		Connecting Piece	1
⑦		Gasket	8

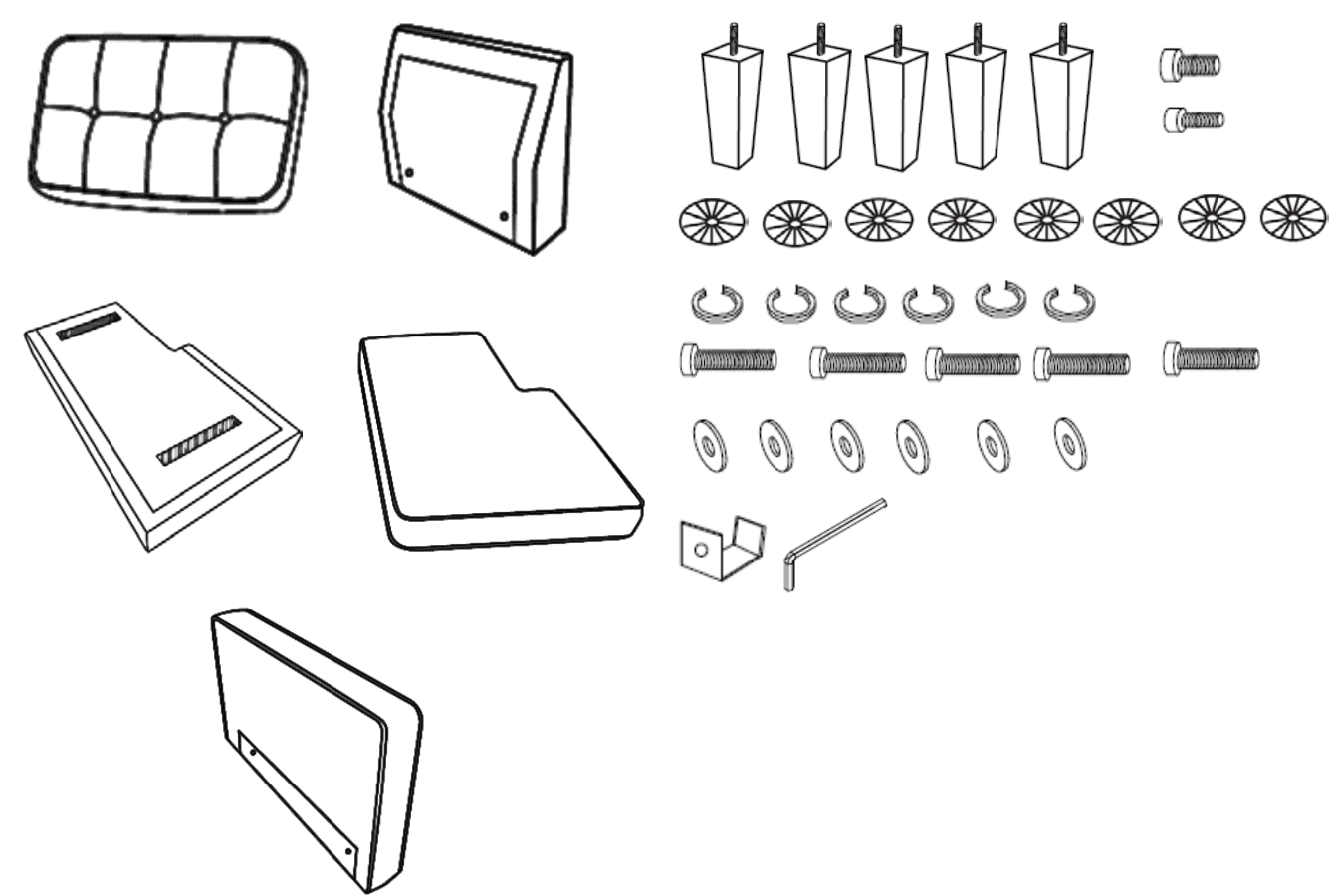
Assembly Preparation

Before Beginning Assembly:



-  • Read instructions, cover to cover-
-  • Have 2 adults on hand for assembly-
-  • Do not assemble on flooring or carpet-
-  • Assemble on a clean non-marring surface (packing foam)-
-  • Save all packaging until finished-

Assembly Steps

OVERVIEW

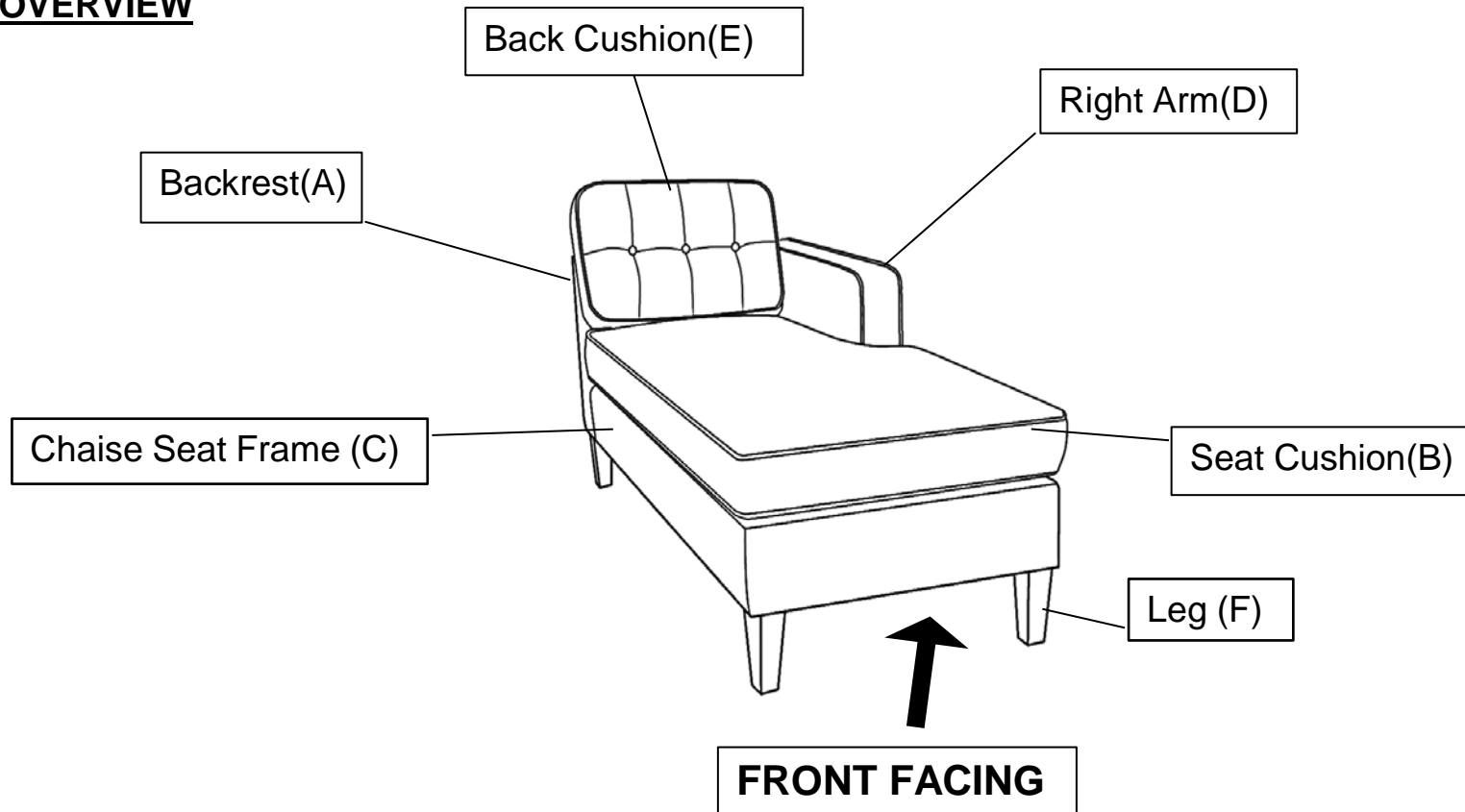

This Sofa has multiple parts and may require up to 30 minutes to assemble. To give you an overview of the Sofa parts, the above picture is to help you put the various Sofa parts into perspective. Please read through the instructions to familiarise yourself with the parts and steps before assembly.

Step 1

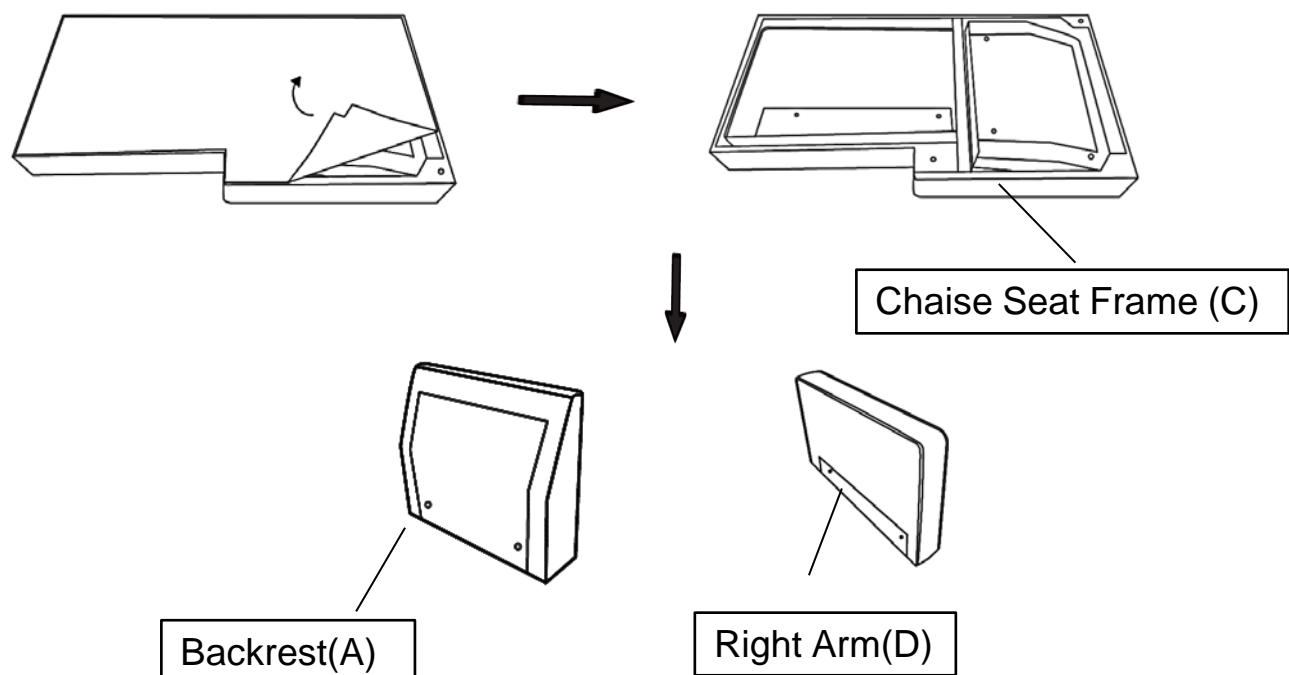

Uncover the non-woven Fabric and remove Backrest(A),Right Arm(D),Hardware Package from Chaise Seat Frame(C) as shown.

Step 2

Step 2.1

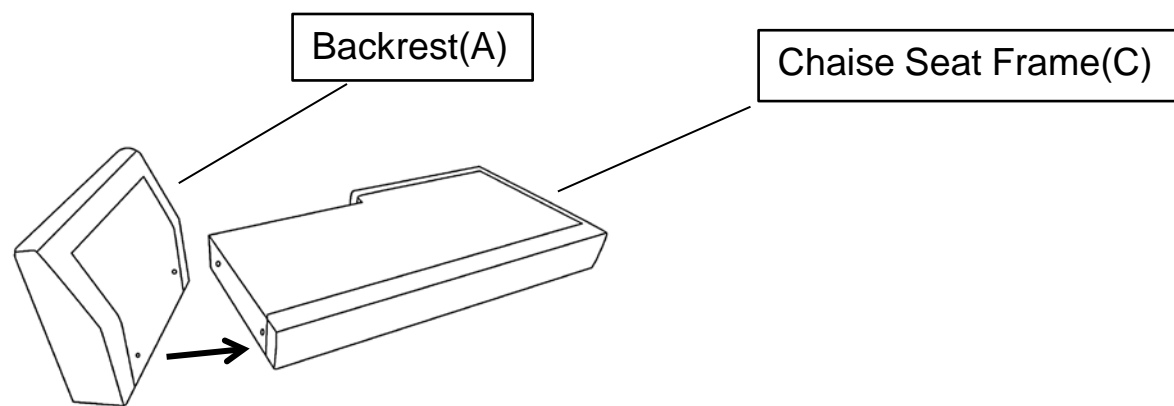

Step 2.2

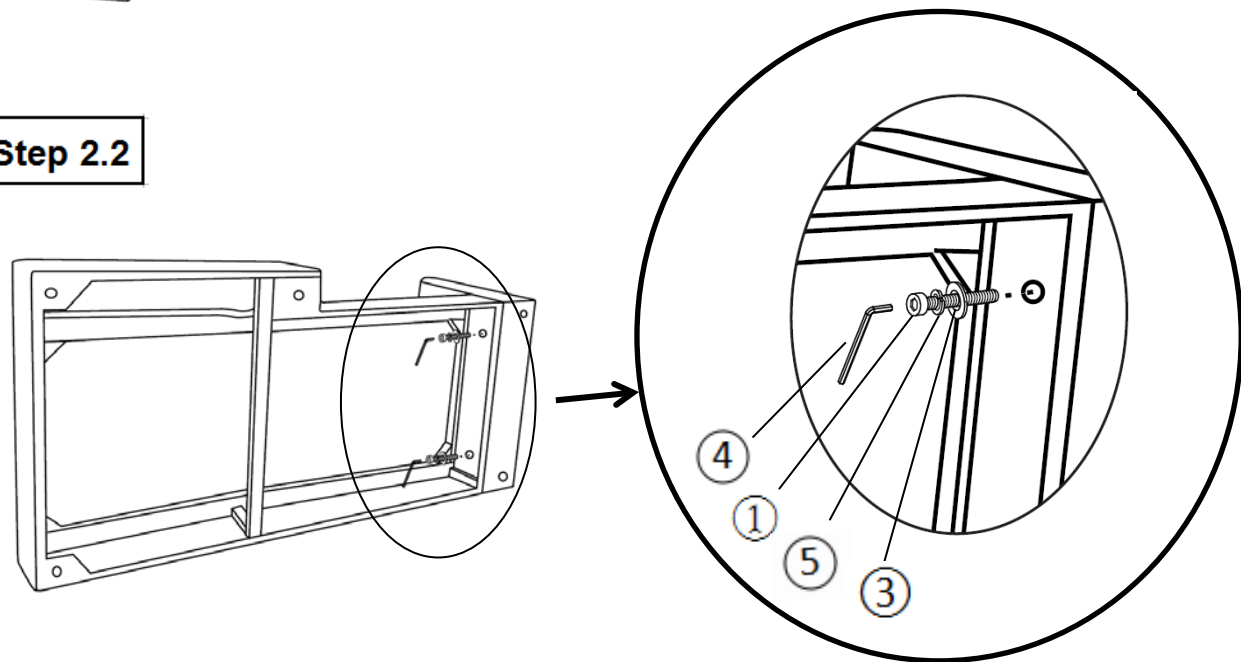

Step 2.1 Position Backrest(A) to Chaise Seat Frame(C) as Shown.

Step 2.2 Attach the Chaise Seat Frame(C) to the Backrest(A) using Bolt(1), Washer Ring(5), Washer(3) with Allen Key(4).

Step 3

Step 3.1

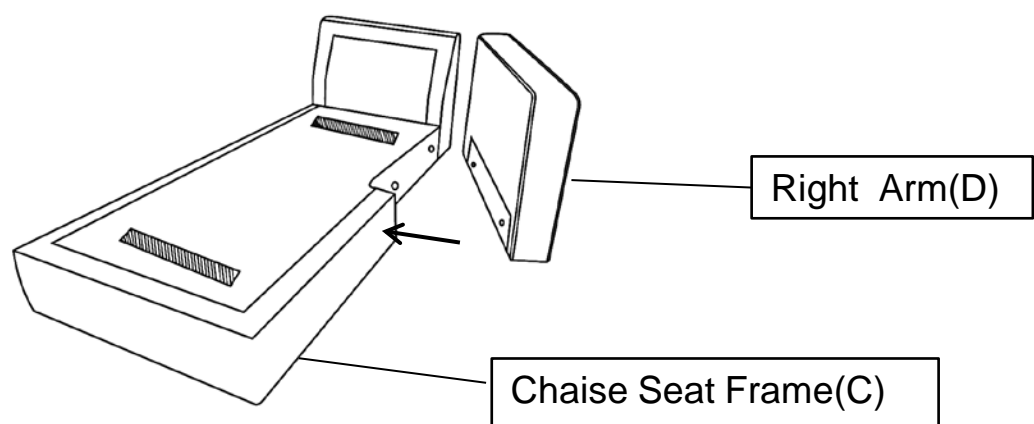

Step 3.2

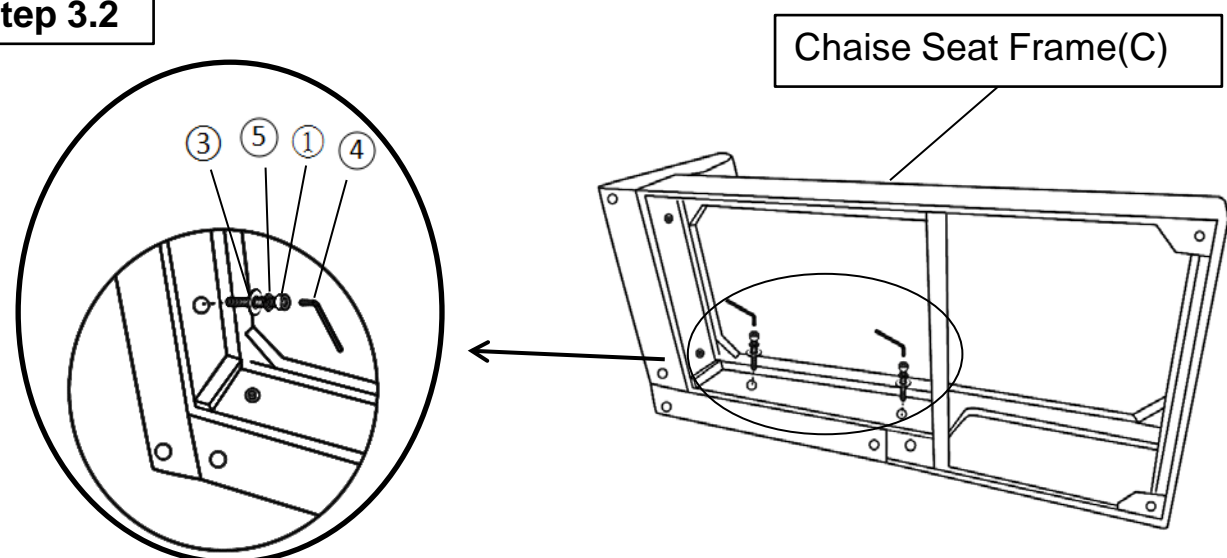

Step3.1 Position Chaise Seat Frame(C) to Right Arm(D) as Shown.
 Step3.2 Attach the Chaise Seat Frame(C) to the Right Arm(D) using Bolt(①) , Washer Ring(⑤), Washer(③) with Allen Key(④).

Step 4

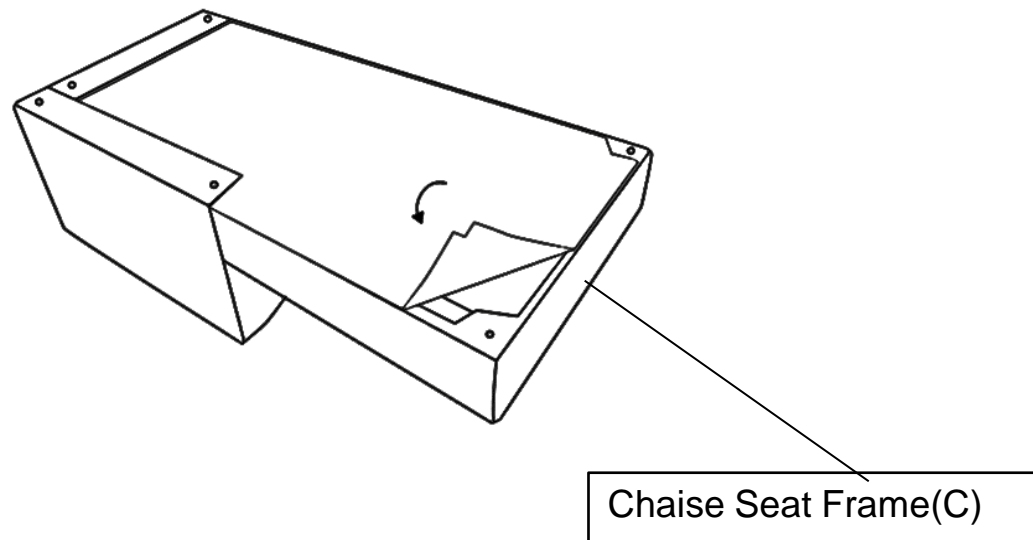

Cover the bottom of the Chaise Seat Frame(C) with the non-woven fabric.
 Smooth down the Magic Tape on all four sides of the Seat by hand.

Step 5

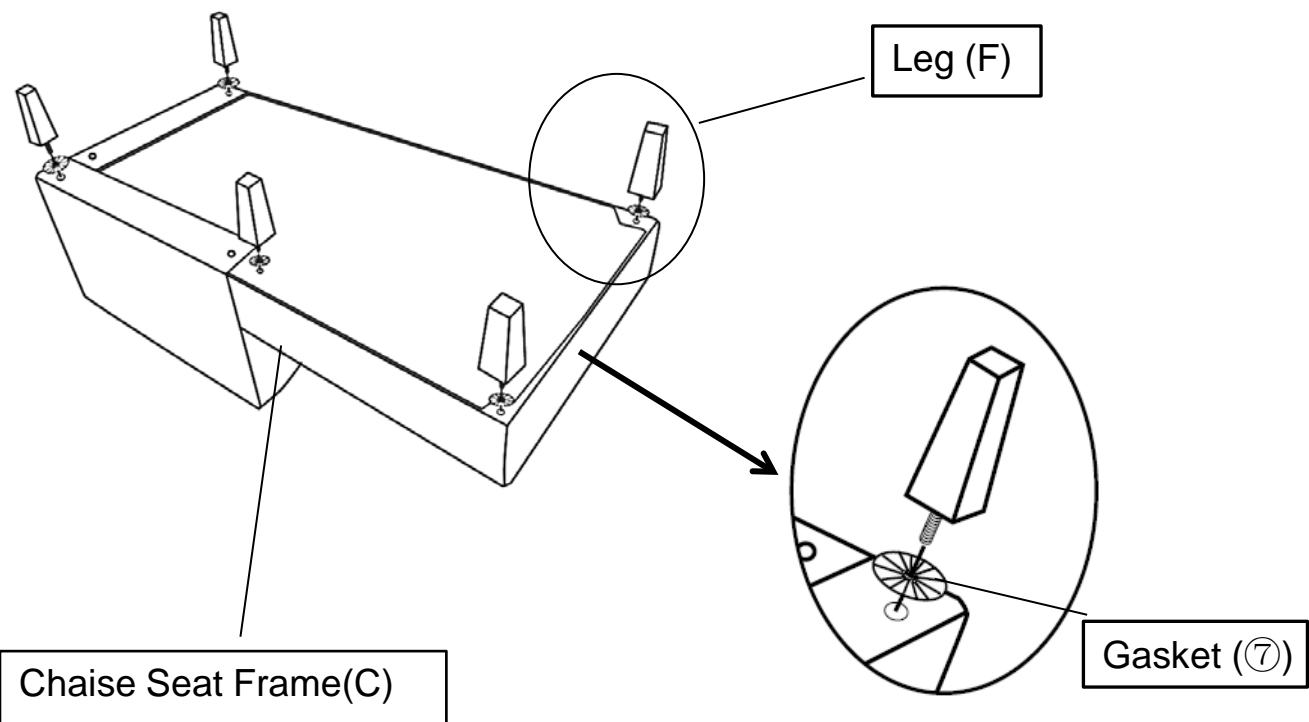

Install the Legs(F) into the bottom of Chaise Seat Frame(C) by placing a Gasket(⑦) onto the threaded stem of the Legs.
 And then insert the threaded stem into the threaded mounting position at each Corner of Chaise Seat Frame(C).
 Tighten by turning the Legs clockwise.

Note: The usage of Gaskets(⑦) are OPTIONAL and are especially useful to help alleviate slight wobbles. Some Legs may need more than one Gasket whilst some Legs may not need any.

Position Sofa right side up and test for stability on a Level Surface.
 Add or remove Gaskets(⑦) where needed to achieve stability.

Step 6

Step 6.1

Seat Cushion(B)

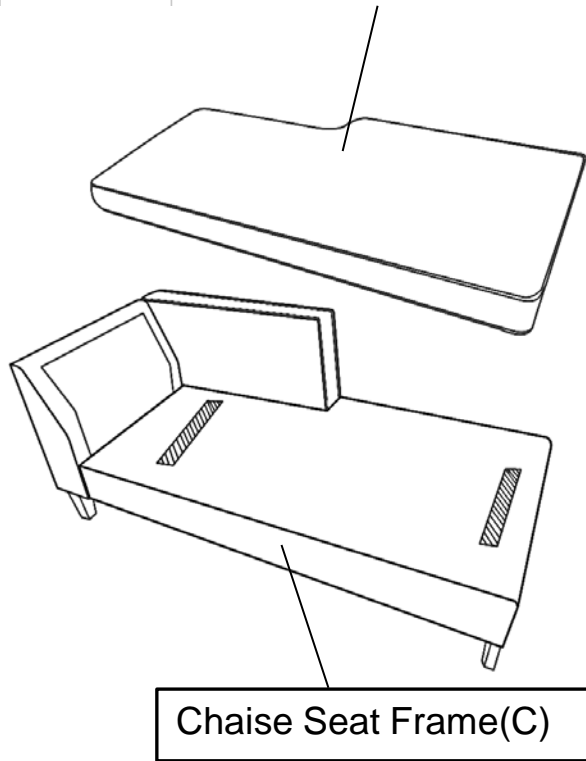

Step 6.2

Back Cushion(E)

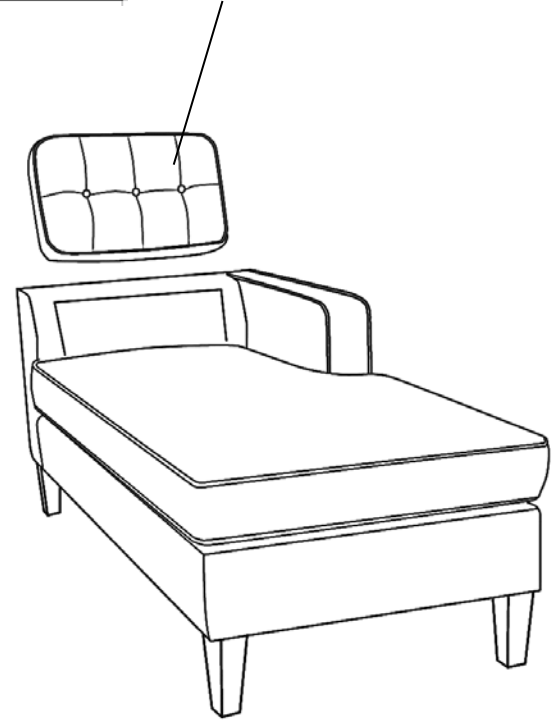

Step 6.1 Put the Seat Cushion(B) on the Chaise Seat Frame(C) as shown.
Step 6.2 Put the Back Cushion(E) on the Chaise Seat Frame(C) as shown.

Step 7

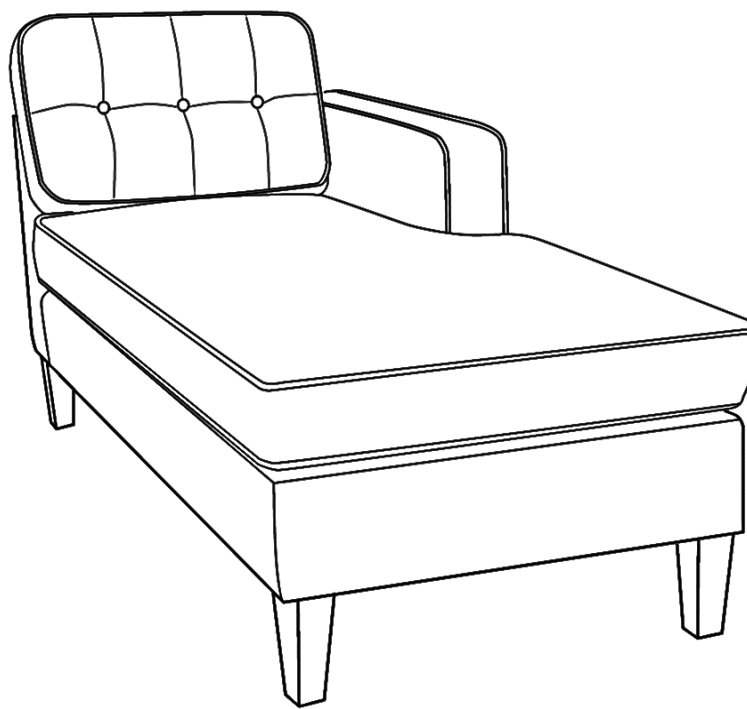

Your Right Arm Sofa is ready for use.
Your Right Arm Sofa can only be used on a flat, level surface.





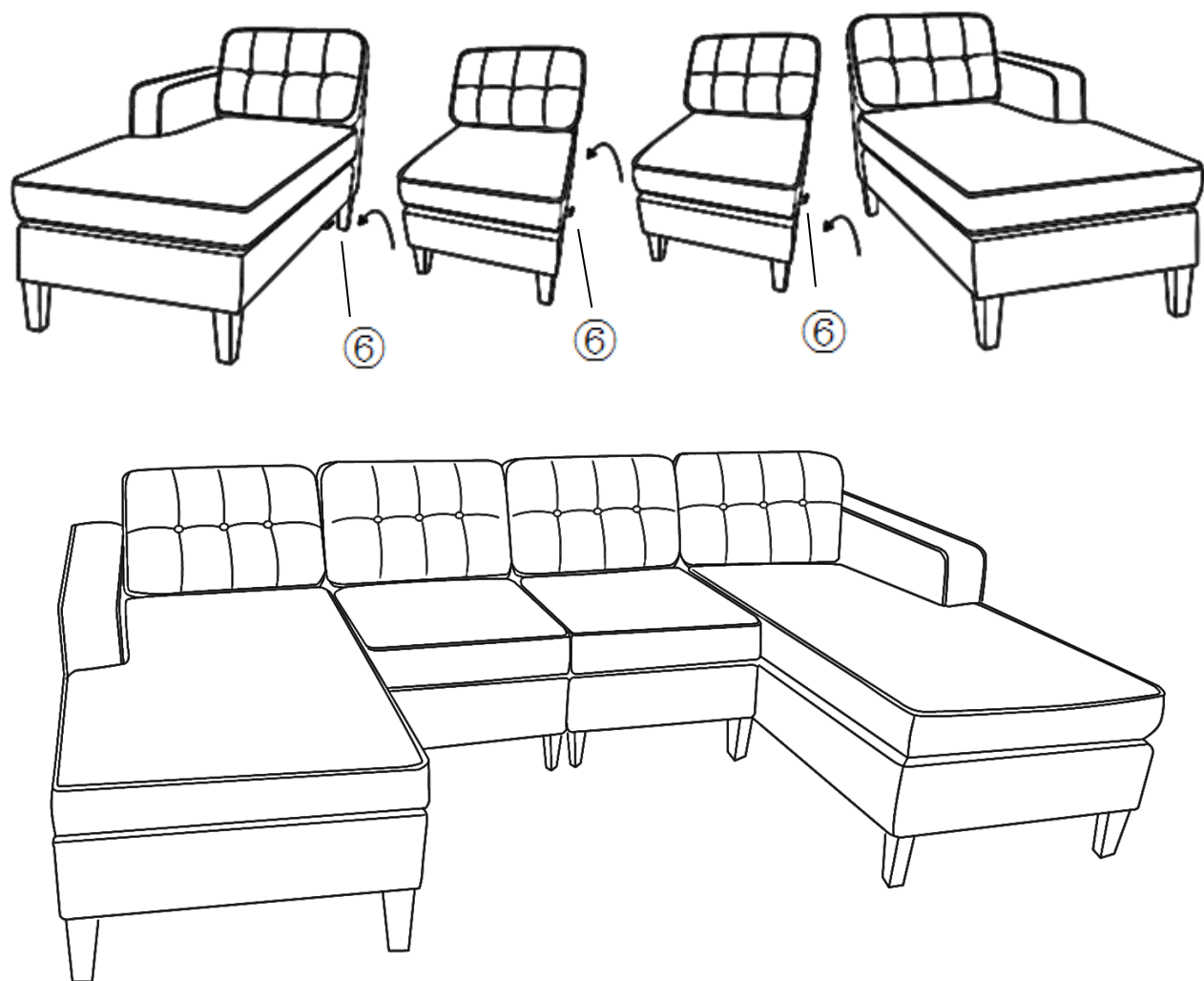















If you already purchased 2 or more than 2 products, Please read on

Step 8



Connecting the two sofas by using the pre-fixed Connecting Piece(®) as shown in above picture.

Care & Maintenance

-   ● Do not put hot items directly on furniture surface
 -   ● Do not clean furniture with harsh cleansers or polish.
 -   ● Do not place furniture under direct sunlight.
 -   ● Do not place furniture near heating or cooling vents.
 -   ● Do not write on furniture without a padded barrier to protect the surface.
 -   ● Do not place furniture outside . For indoor use only .
 -   ● Not for commercial use. For residential use only .
 -   ● Stains may be removed with mild soap solution and damp cloth.
 -   ● Children should not climb or jump on the furniture.
-
-   ● Dust and pick-up spills using a clean, non-colored, lint-free cloth .

Questions & Answers about Proposition 65

• What is Proposition 65?

Proposition 65 requires businesses to provide warnings to Californians about significant exposures to chemicals that cause cancer, birth defects or other reproductive harm. These chemicals can be in the products that Californians purchase, in their homes or workplaces, or that are released into the environment. By requiring that this information be provided, Proposition 65 enables Californians to make informed decisions about their exposures to these chemicals.

Proposition 65 also prohibits California businesses from knowingly discharging significant amounts of listed chemicals into sources of drinking water.

Proposition 65 requires California to publish a list of chemicals known to cause cancer, birth defects or other reproductive harm. This list, which must be updated at least once a year, has grown to include approximately 900 chemicals since it was first published in 1987.

• What types of chemicals are on the Proposition 65 list?

The list contains a wide range of naturally occurring and synthetic chemicals that include additives or ingredients in pesticides, common household products, food, drugs, dyes, or solvents. Listed chemicals may also be used in manufacturing and construction, or they may be byproducts of chemical processes, such as motor vehicle exhaust.

• What does a warning mean?

If a warning is placed on a product label or posted or distributed at a workplace, a business, or in rental housing, the business issuing the warning is aware or believes that it is exposing individuals to one or more listed chemicals.

By law, a warning must be given for listed chemicals unless the exposure is low enough to pose no significant risk of cancer or is significantly below levels observed to cause birth defects or other reproductive harm.

• Where can I get more information on Proposition 65?

If you have specific questions on the administration or implementation of Proposition 65, you can contact OEHHA's Proposition 65 program at P65.Questions@oehha.ca.gov, or by phone at (916) 445-6900.