

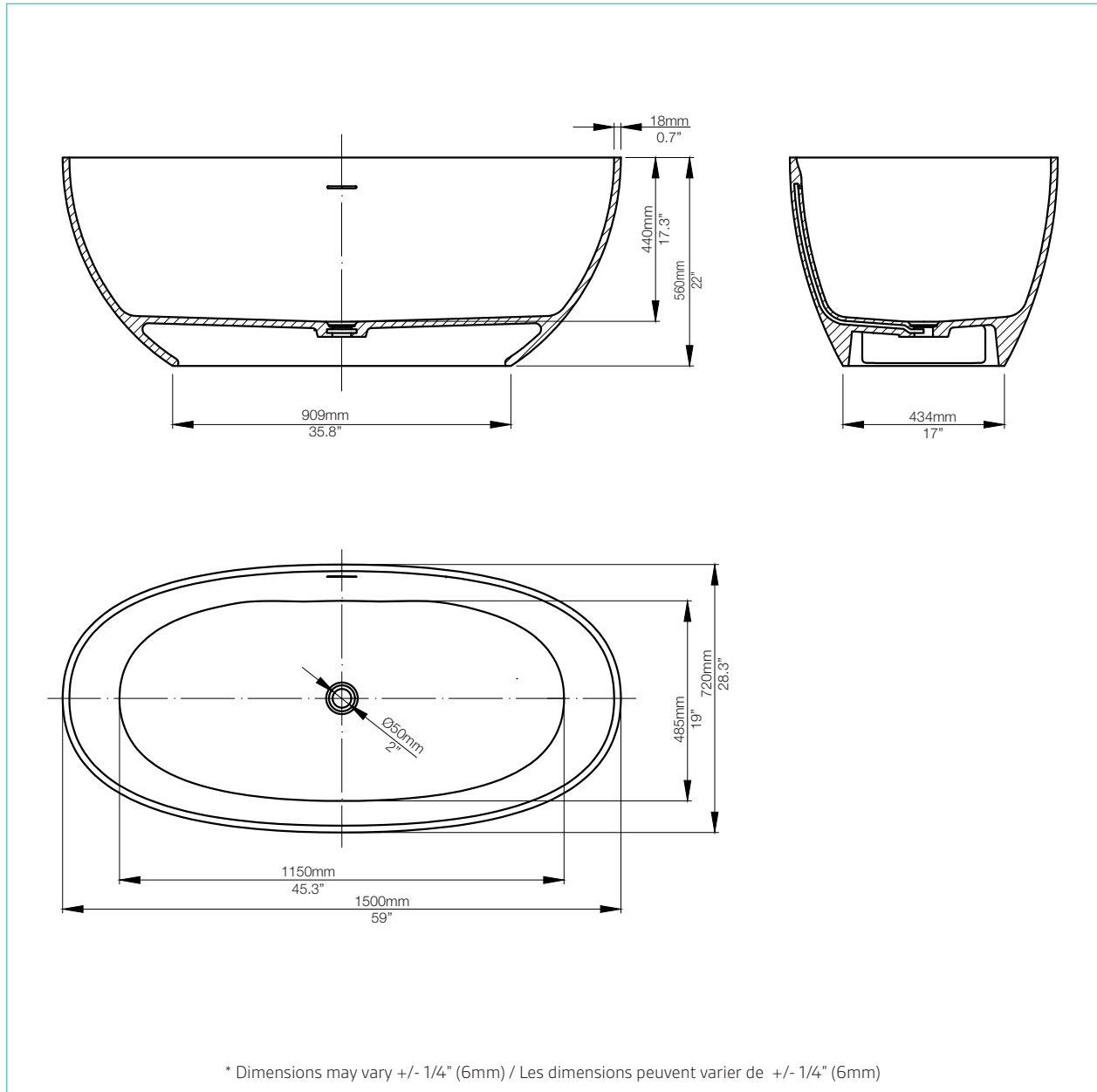

**FREESTANDING
BATHTUBS**

**BAIGNOIRES
AUTOPORTANTES**

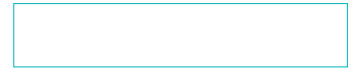

DIMENSIONS	WEIGHT POIDS	MATERIAL MATERIEL	OVERFLOW HEIGHT HAUTEUR DU TROP-PLEIN	WATER CAPACITY CAPACITÉ DE L'EAU
59 x 28.3 x 22" 1500 x 720 x 560 mm	212 lbs 96 Kg	Aluminum powder & resin Poudre d'aluminium et résine	14" 357mm	74 gal 336 lts
FINISH FINITION	DRAIN LOCATION LOCATION DU DRAIN	PIECES PIÈCES	COMPLIANCE CERTIFICATIONS:	
Matte White Blanc mat	Center Centré	1 pc	Uniform Plumbing Code National Plumbing Code of Canada CSA B45.5-17/IAPMO Z124-2017	

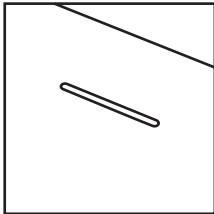
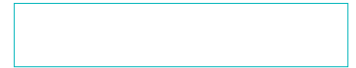

Linear overflow
Trop plein linéaire

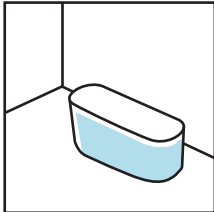

Freestanding installation
Installation autoportante

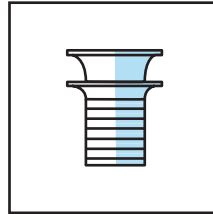

Pop-up drain
included
*Drain pop-up
inclus*



cUPC Certified
Certifié cUPC

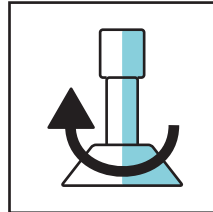

Adjustable feet
Pieds ajustables