









PARTSLIST		
LABEL	PICTURE	QTY
A		1
B-L		1
B-R		1
C		1
D		1
E		1
HARDWARE		
LABEL	PICTURE	QTY
F	M6X16 	4
G	M6X30 	11
H		4
J		1

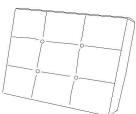

Step1

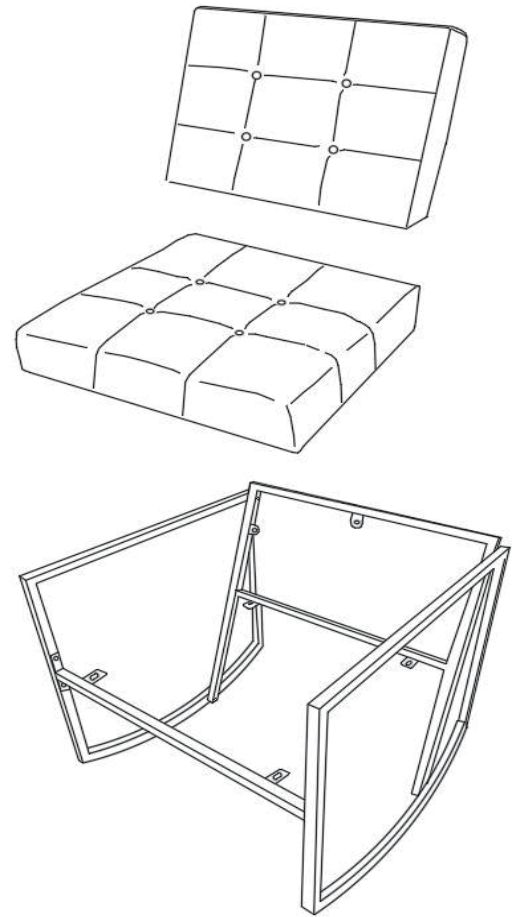
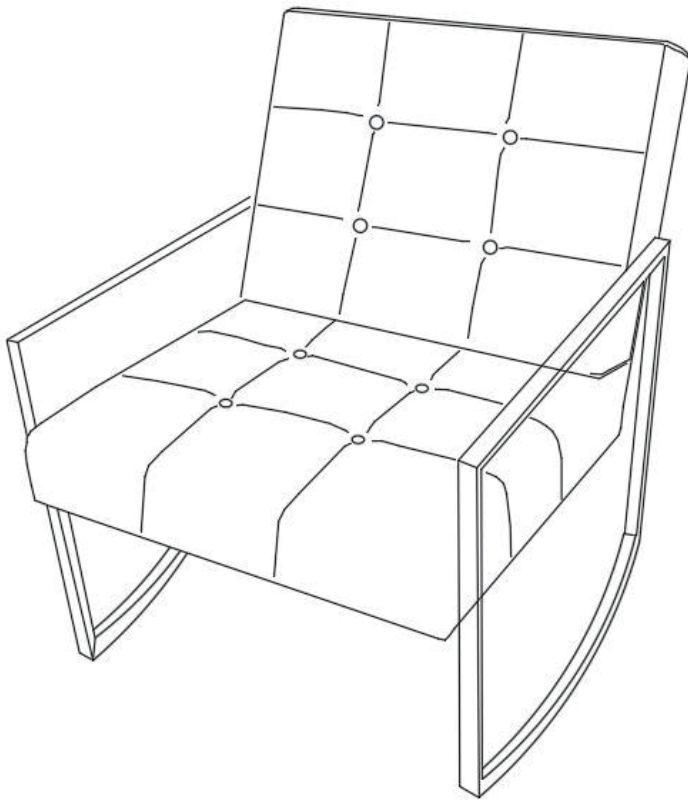
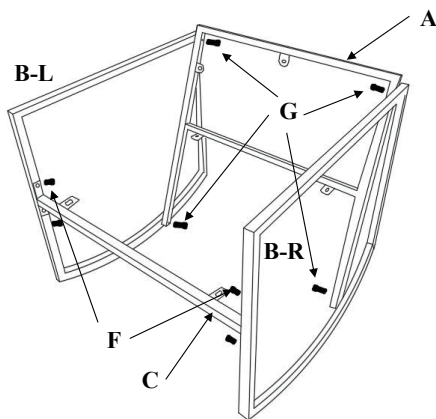

DO NOT OVER-TIGHTEN SCREWS UNTIL STEP 3 IS COMPLETE

Step2

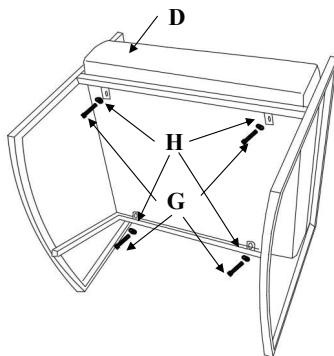

Step3

