

SOOHOW

Assembly Manual

Love seat

CS003

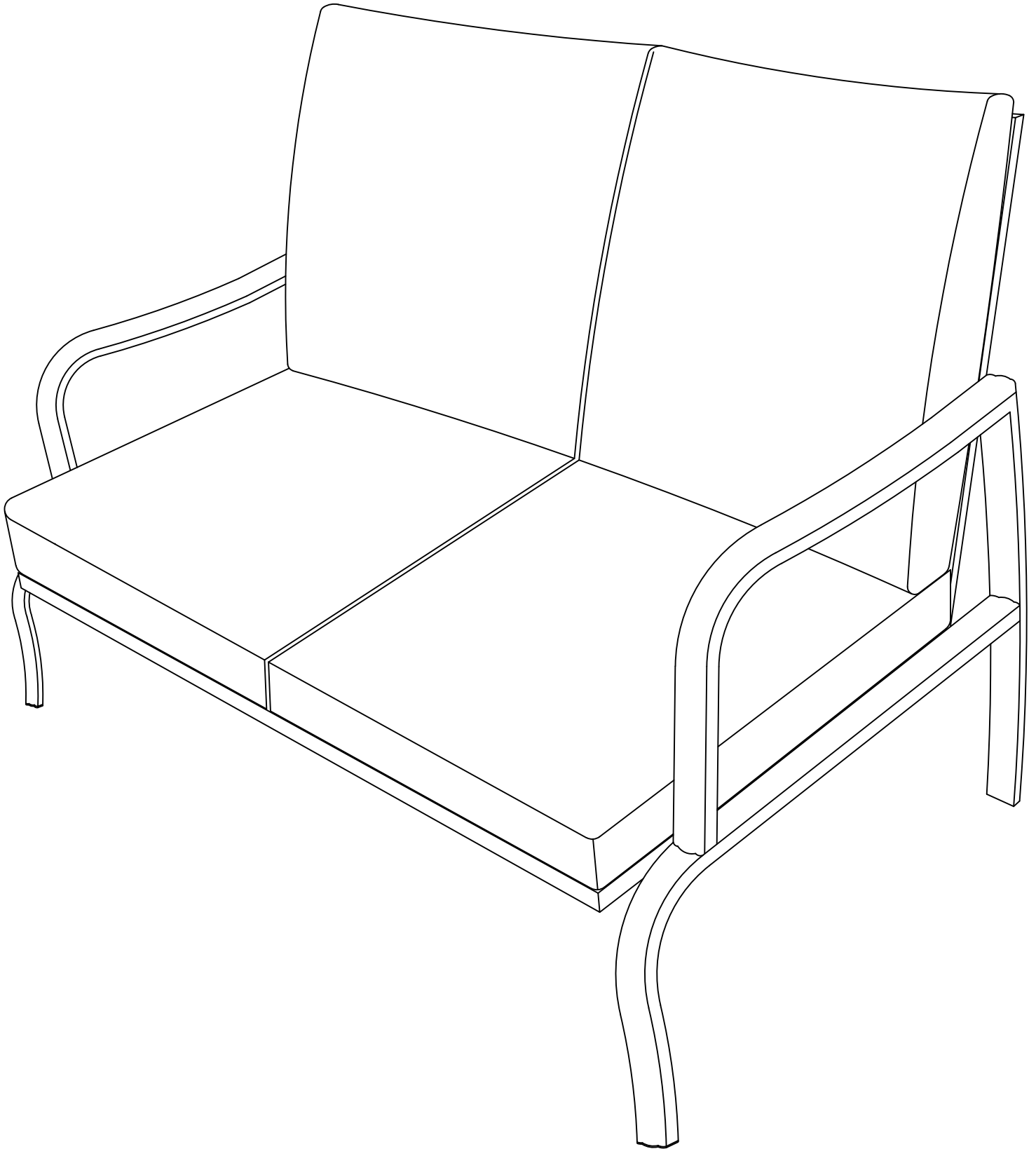

Please read this manual carefully before any operation and keep it properly for future use.

If any problems on our product, please feel free to contact us at ecservice@isunon.com.

Exploded View

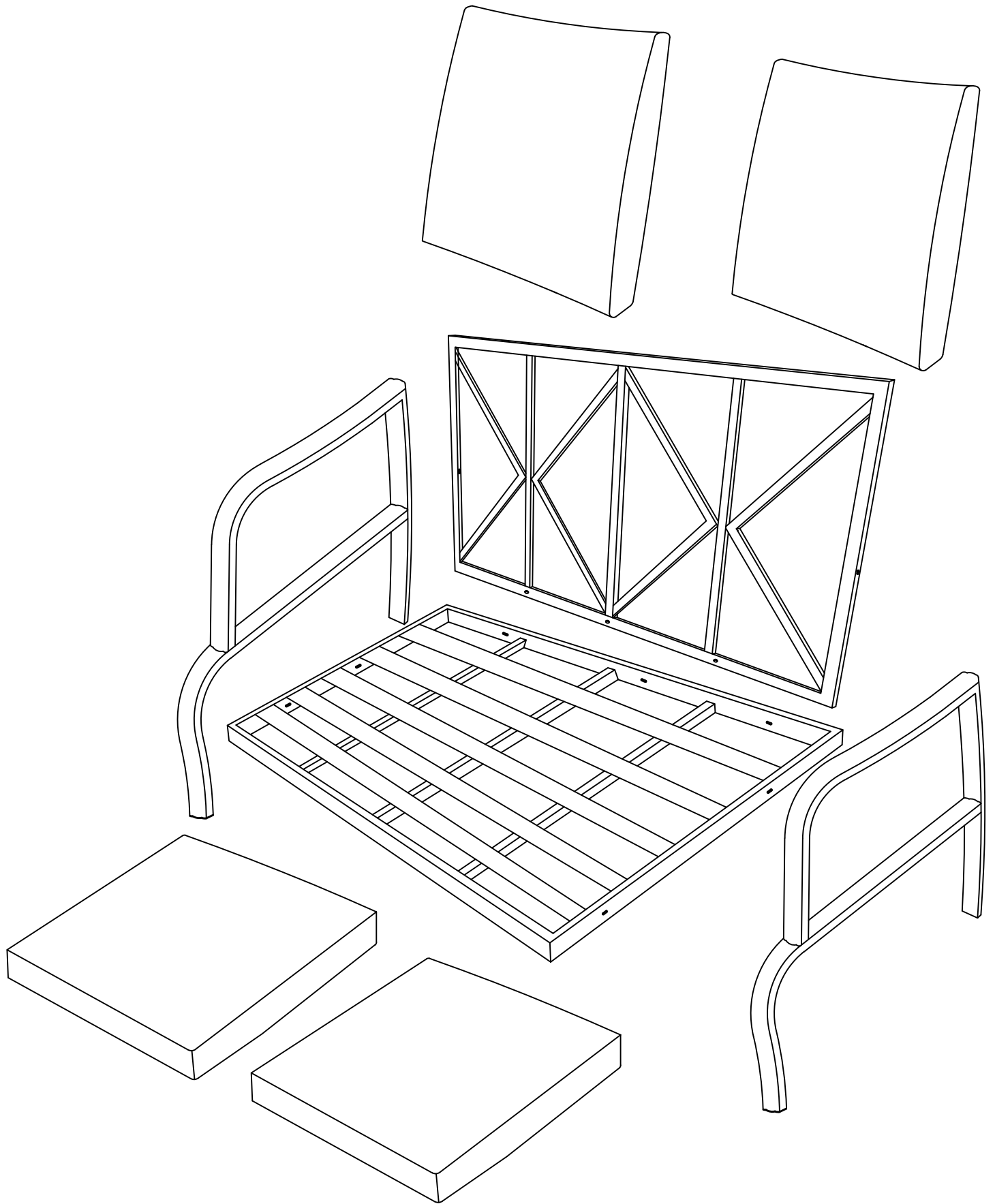

Components List

A

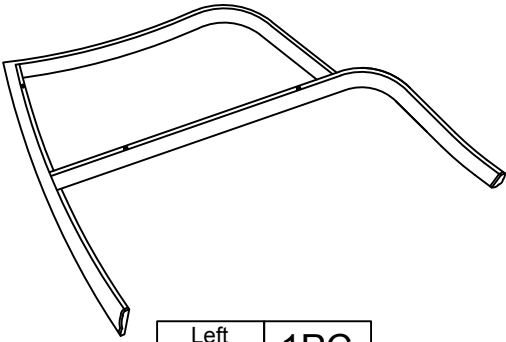

Left Armrest 1PC

B

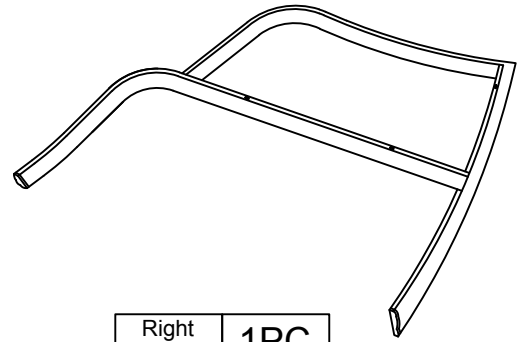

Right Armrest 1PC

C

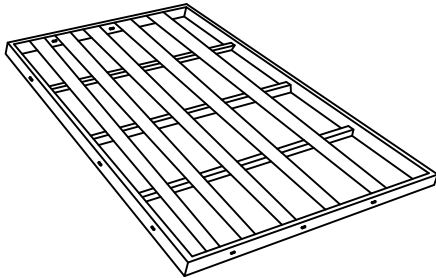

Seat 1PC

D

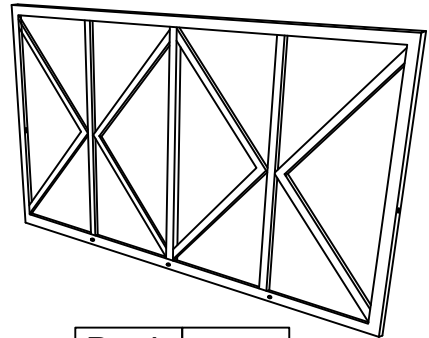

Back 1PC

E



Bolt M6X30 8PCS

F

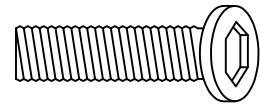

Bolt M6X40 3PCS

G



Washer M6 11PCS

H

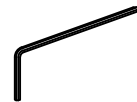

Allen wrench M6 1PC

I

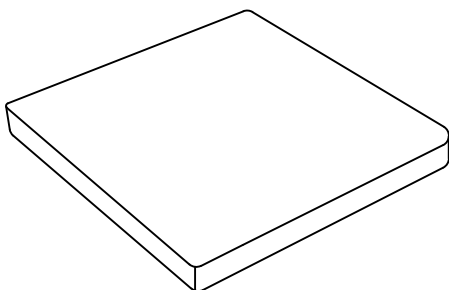

Seat Cushion 2PCS

J

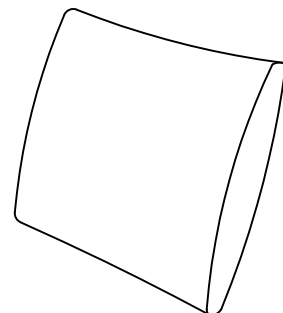

Back Cushion 2PCS

ASSEMBLY INSTRUCTION

Step 1 Attach left armrest(A) to the seat board(C) using washers(G), bolts(E) and Allen wrench(H). Hand-tighten all screws to about 80% first. After all screws are in place, tighten them fully in sequence

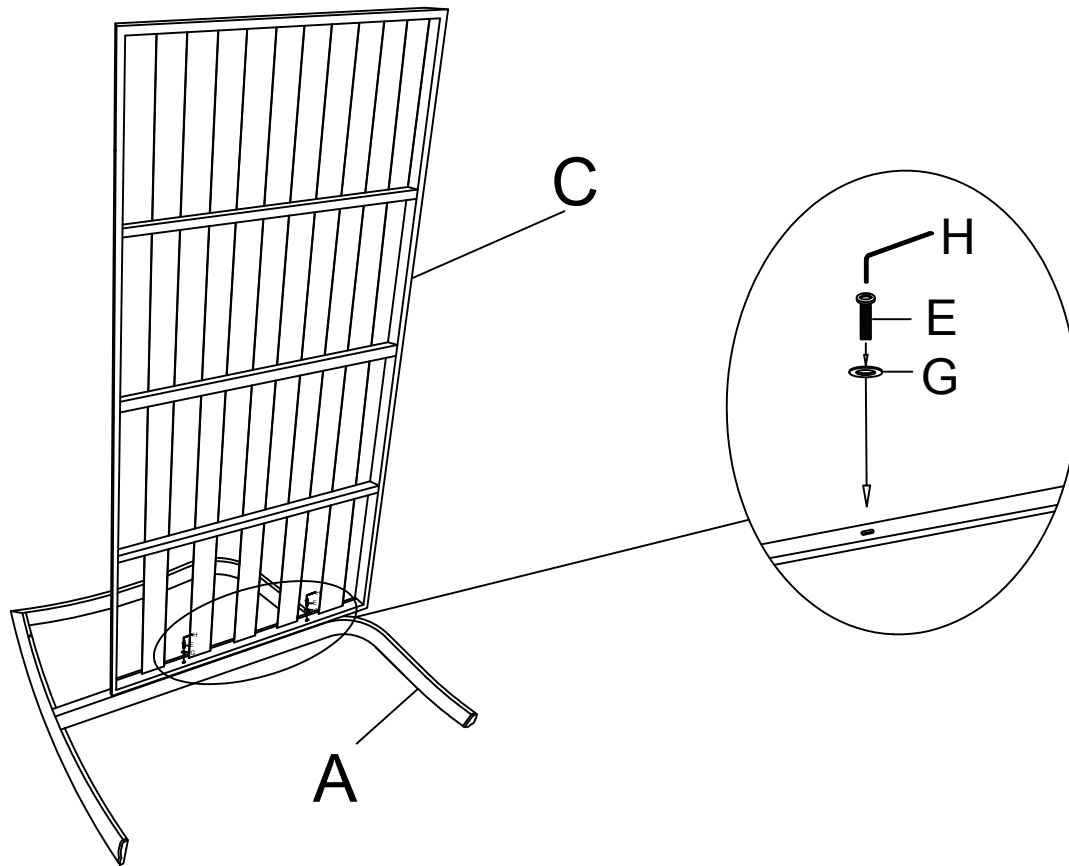

	AX1
	CX1
	EX2
	GX2
	HX1

Step 2 Attach back frame(D) to the seat frame using washers(G), bolts(E&F), and Allen wrench(H). Hand-tighten all screws to about 80% first. After all screws are in place, tighten them fully in sequence

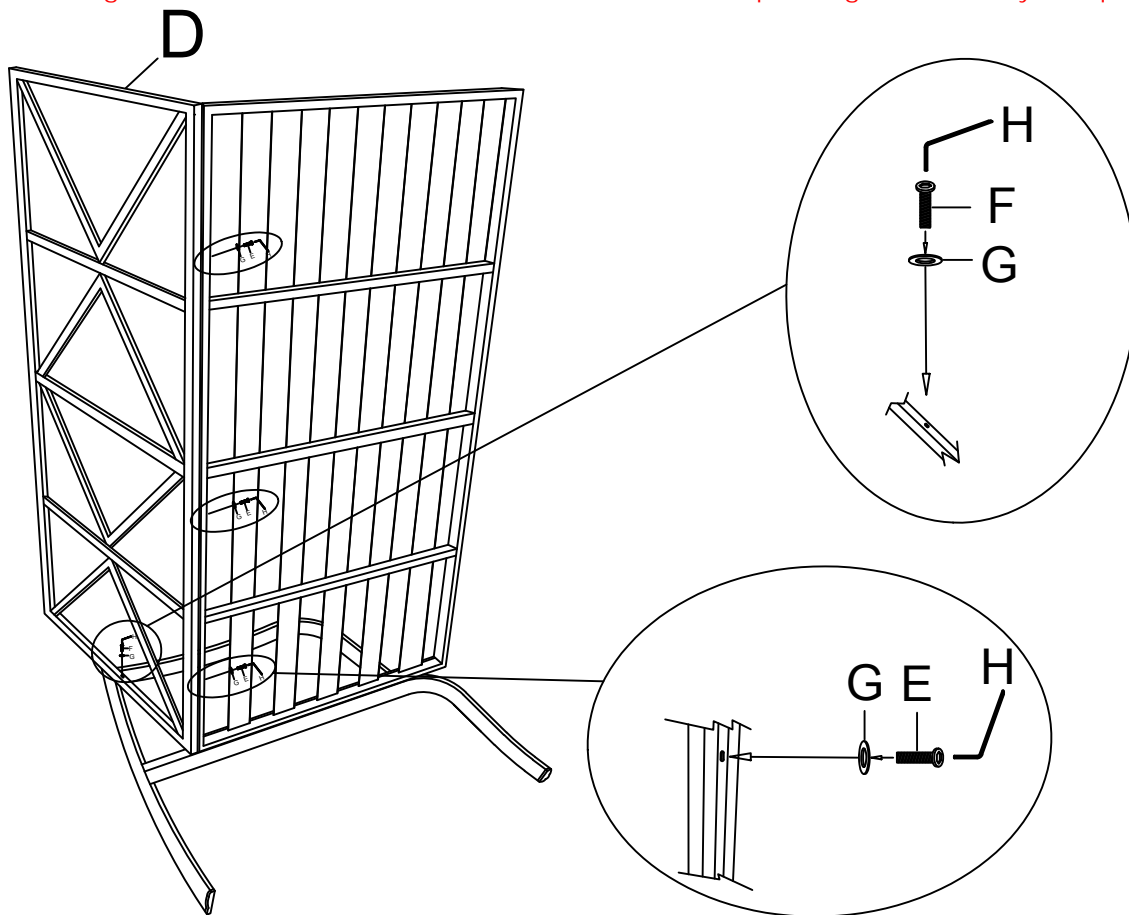

	DX1
	EX3
	FX1
	GX4
	HX1

ASSEMBLY INSTRUCTION

Step 3 Attach right armrest(B) to the seat board(C) using washers(G), bolts(E) and Allen wrench(H). **Hand-tighten all screws to about 80% first. After all screws are in place, Hand-tighten all screws to about 80% first. After all screws are in place, tighten them fully in sequence**

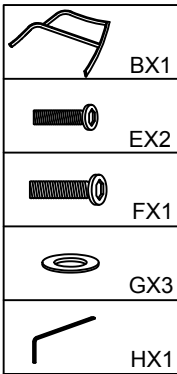
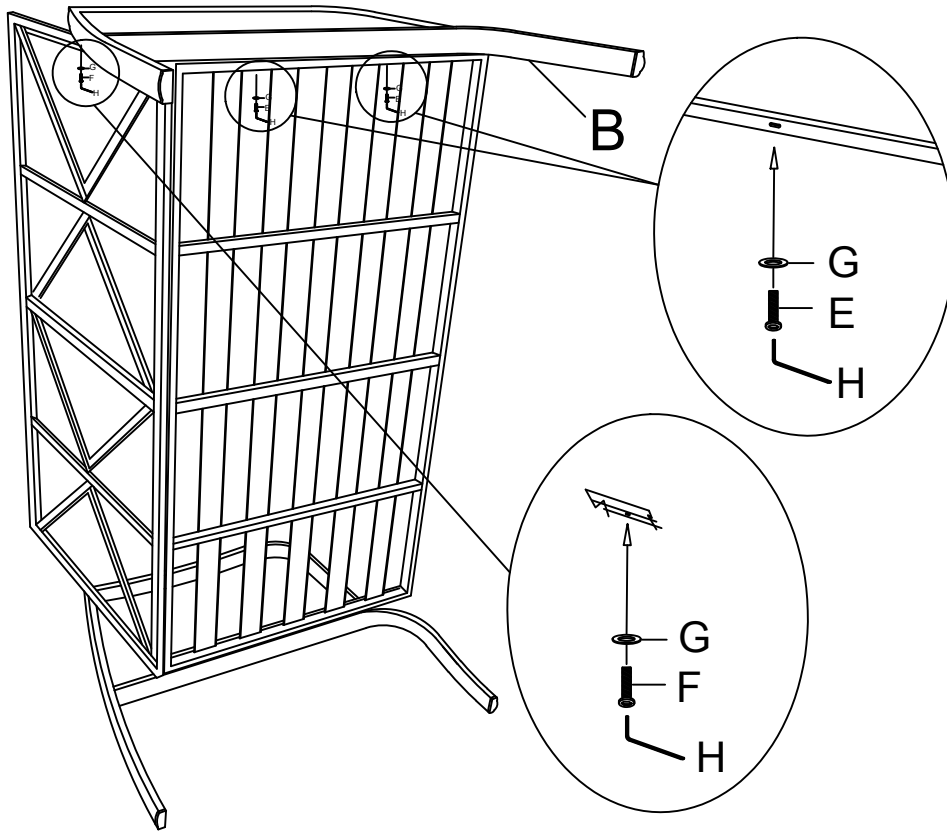

Step 4 Tighten all bolts 100%, and flip the seat over. Put the seat cushion(I) and back cushion(J) on the seat frame. The assembly is done.

