

# DREAMS

IDEA

Instruction Manual



DREAMS/DEA

NO:OD1001-LOVESEAT

# ABOUT US

**D**REAMSIDEA IS A ONE-STOP HOME  
FURNISHING AND SERVICE COMPANY BASED IN USA.

WE ARE DEDICATED TO BRINGING YOUR DREAM HOME TO LIFE.

OUR SERVICES COVER FROM DESIGN, PRODUCTION,  
DIRECT SELL, STORAGE, AND TRANSPORTATION.

IF REALITY IS THE NEAR SHORE

AND IDEALISM THE FAR SHORE,

**D**REAMSIDEA

AS THE FERRY BETWEEN THEM,

EAGER TO ACCOMPANY YOU ON A JOURNEY

TO YOUR IDEAL HOME.



ITEM NO.OD1001-LOVESEAT

# WARRANTY

We strive to offer high quality product and we also try our best to satisfy each customer that order from us, no matter on products or services as needed. Each customer receives a record of their order, such as the order number or item receipt. For any items that are out of warranty period, you may still be able to purchase the replacement parts from our company if they are available.

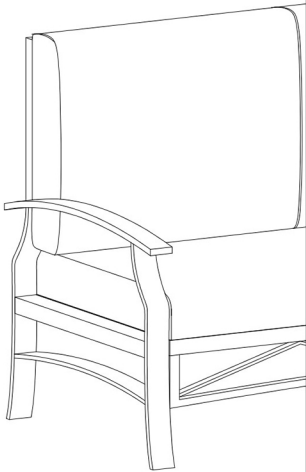

Are you having difficulty  
with assembly? Missing parts?

Please contact us : [info@firstopintl.com](mailto:info@firstopintl.com)

Tel: (562)-781-3327

send an email with your order No. to us

For return, please check the return policy with  
the retailer or platforms you bought from.

Appreciate your purchasing from us.

Pop up your life by our furniture !

# MAINTENANCE AND WARNING

Please read the manual thoroughly  
before you start installing.

Please keep the product away from  
sharp object.

Packaging and small parts may have  
chocking hazard, please keep them away  
from children and pets.

Please clean the product according to each  
clean code, check the product description  
for more information.

Please keep the product away from  
fire.

If you have any other questions, please  
contact us, we will be glad to help you out.

If the product is placed under direct  
sunlight, the pattern or color might fade  
away overtime.

Check the product periodically to make  
sure everything is secured and tightened.

Always use proper tools for installation.

Do not jump on the product.

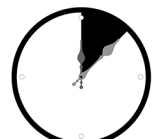
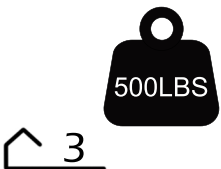

Around 45 min

# PRDOUCT DESCRIPTION

This outdoor patio sofa is a cozy spot to unwind on your patio or deck.

The sleek frame with curving arms is crafted from steel with a glossy black finish, and it's accented with a breezy wicker apron for a mix of materials.

This patio sofa includes four padded polyester cushions that are water, oil, fade, and stain-resistant, so they stand up to the elements.

Plus, the cushion covers are removable and machine-washable, making maintenance a breeze.

To keep this patio sofa looking its best, store it indoors or cover it when not in use.

Dream



House

# EXPLODED VIEW



The product's left and right are determined by sitting posture

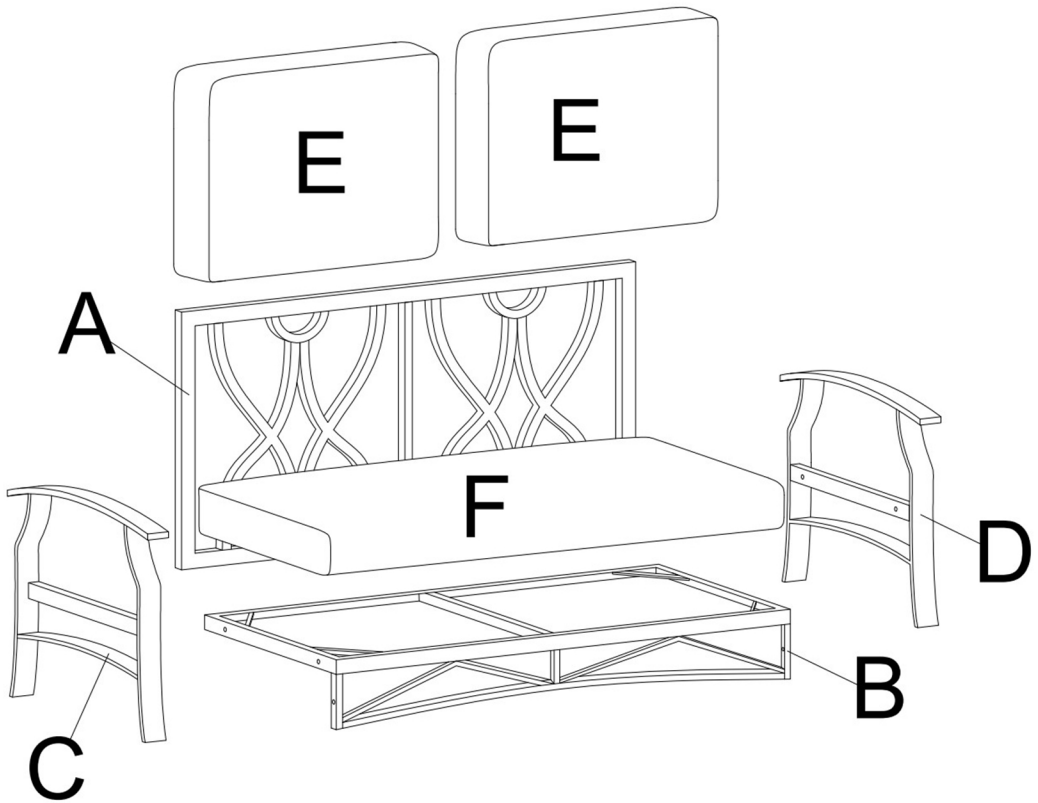

# PARTS

A\*1

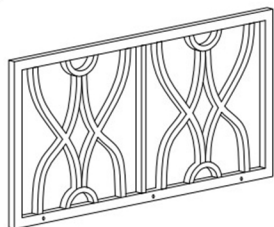

Backrest

B\*1

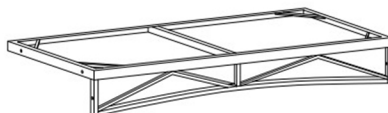

Seat frame

C\*1



Right arm

D\*1



Left arm

E\*2

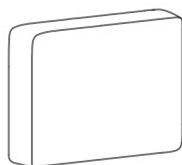

Back cushion

F\*1



Seat cushion

# HARDWARE

## TOOL LIST

NOTE: Designated with (★) We provide additional spare parts in the hardware package

①\*8



★ M6X40mm  
Bolt

②\*3



★ M6X35mm  
Bolt

③\*11



★ Flat washer

④\*1



Allen key

Please make sure all hardware&packing material fitting the list.  
Especially some small accessories may be missing during transportation. Please contact us if you have any question.



# step 1

Align the predrilled holes on backrest (A) with the seat frame (B), Add one washer (3) on each bolt (2) as shown, then align the bolt holes on both seat frame (B) and backrest (A), then use the allen wrench (4) provided to tighten all bolts by 30%-50% at first, ensuring that all bolts are aligned correctly before tightening all bolts.

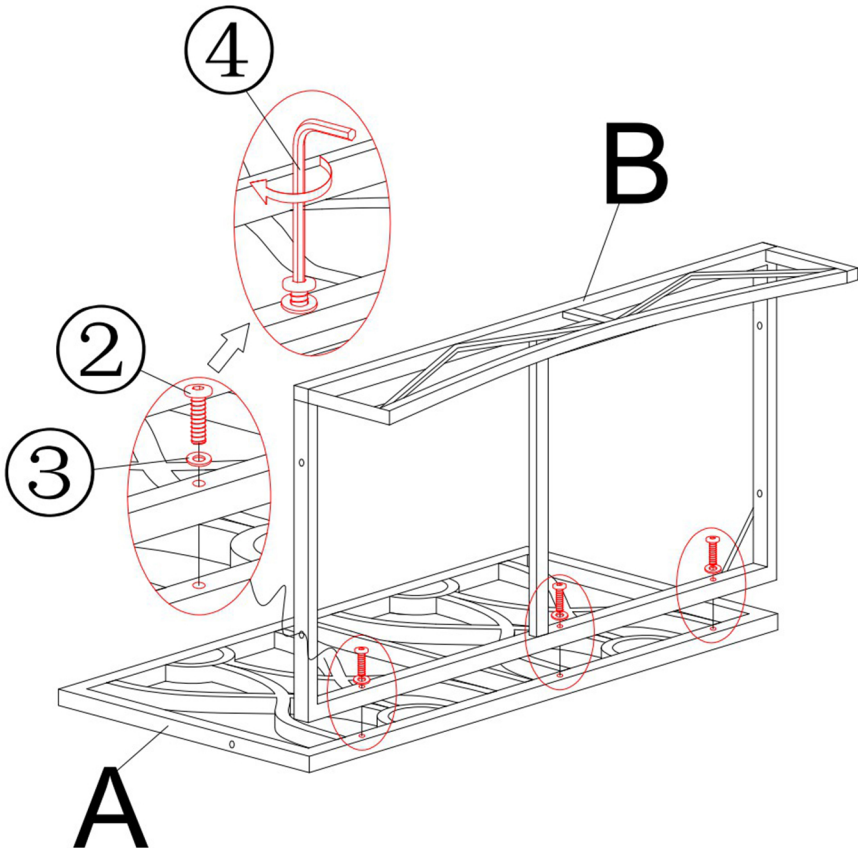

# step 2

Install the right armrest (C) onto the frame, add one washer (3) on each bolt (1) as shown, then align the bolt holes on both seat frame (B) and right armrest (C), then use the allen wrench (4) provided to tighten all bolts by 30%-50% at first, ensuring that all bolts are aligned correctly before tightening all bolts.

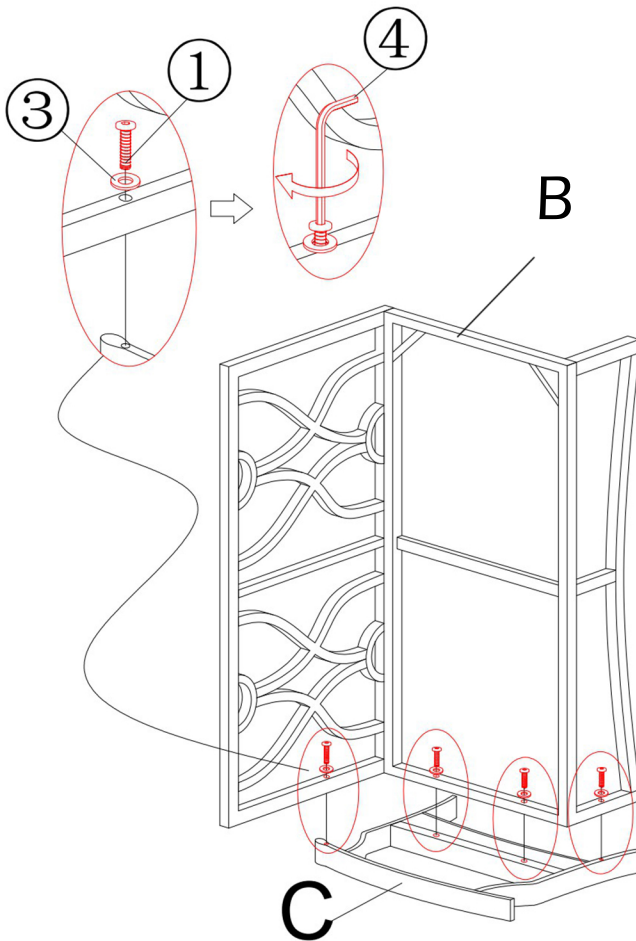

# step 3

Install the left armrest (D) onto the frame, add one washer (3) on each bolt (1) as shown, then align the bolt holes on both seat frame (B) and left armrest (D), then use the allen wrench (4) provided to tighten all bolts by 30%-50% at first, ensuring that all bolts are aligned correctly before tightening all bolts.

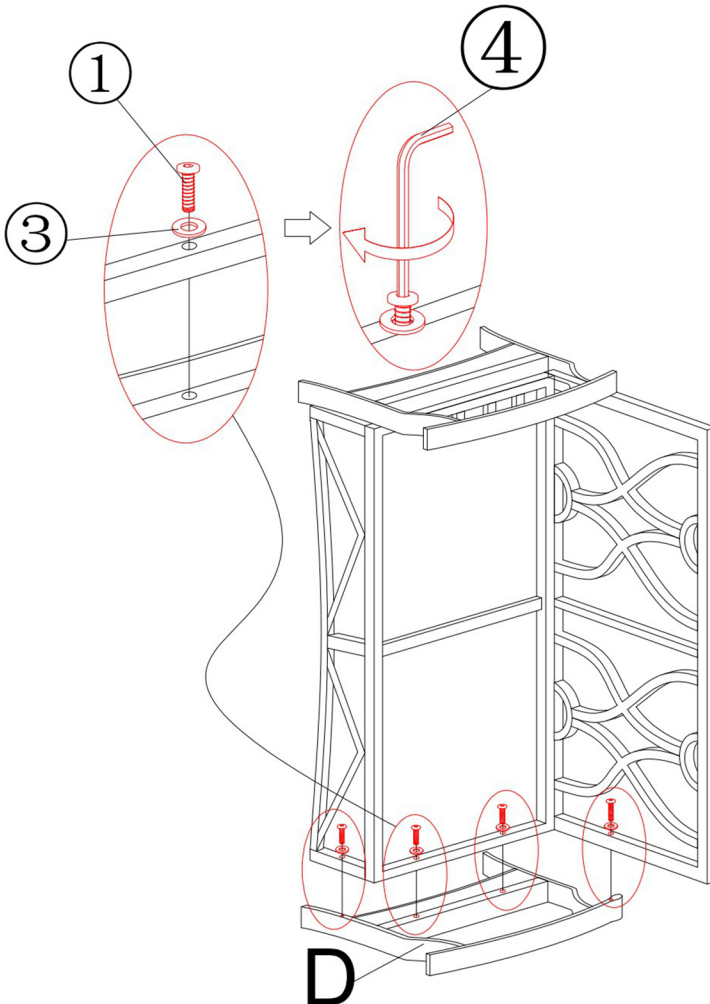

# step 4

Place the seat cushion (F) onto the chair.

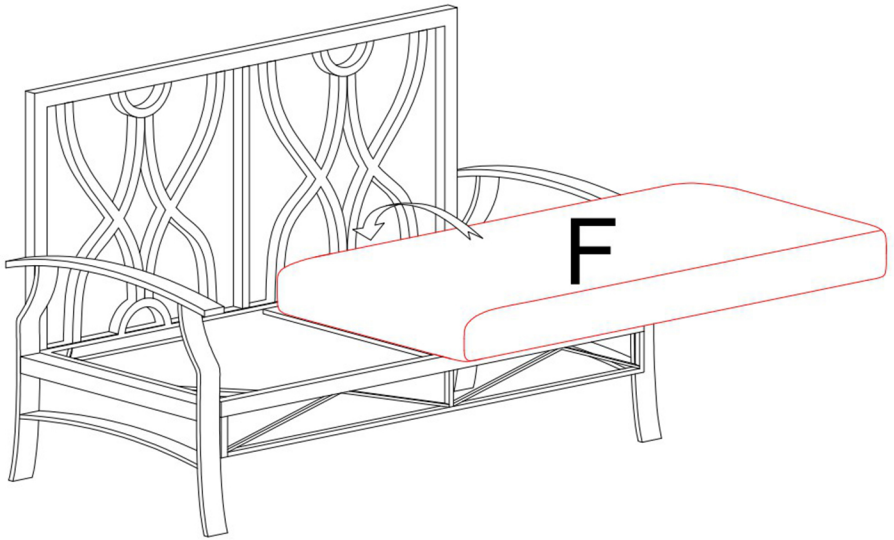

# step 5

Place the back cushion (E) onto the chair.

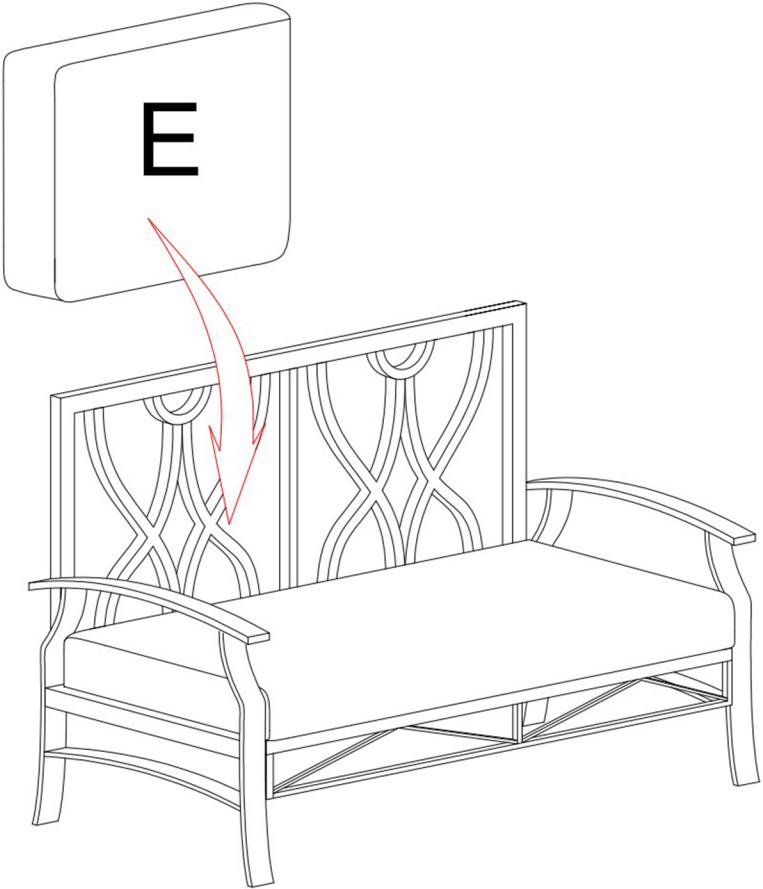

# step 6

Place the back cushion (E) onto the chair.

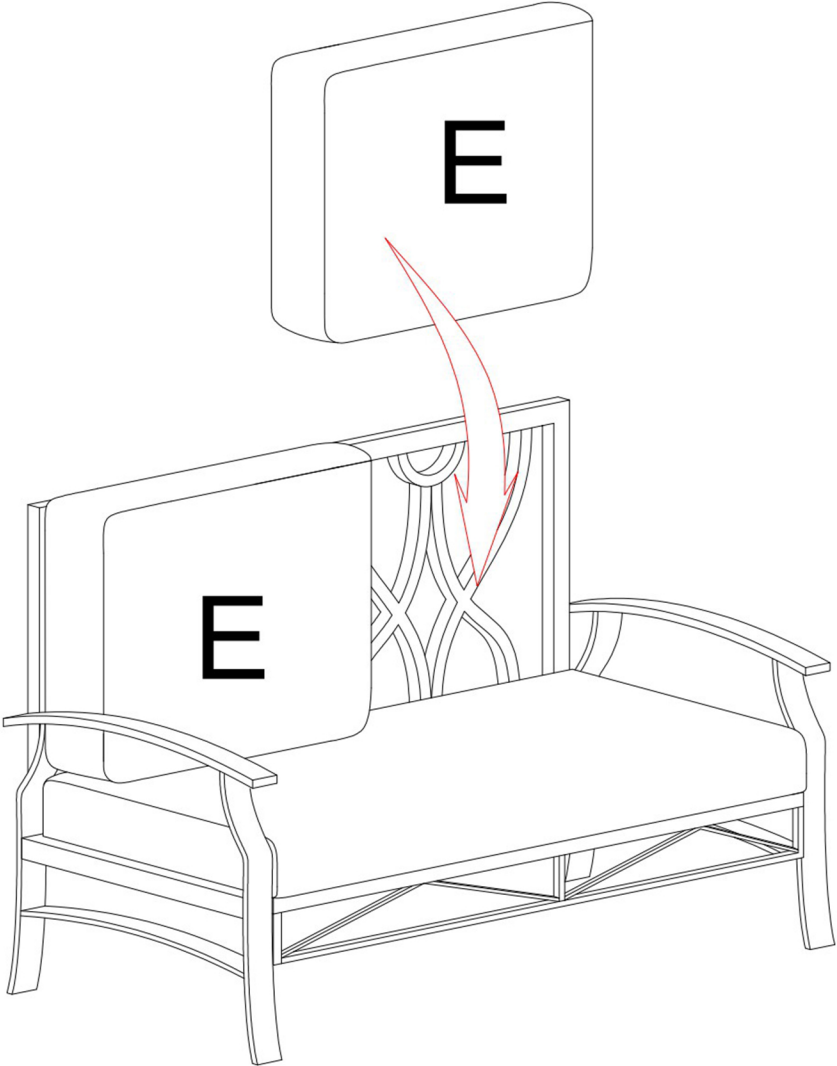

# step 7

Congradulations! You have finished the assembly, thank you again for choosing our product! Please enjoy!

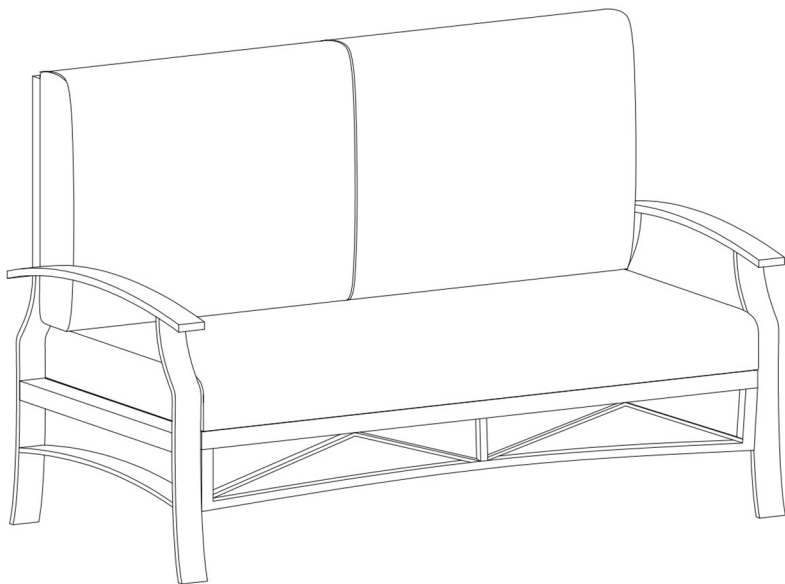

For better user experience, please carefully check all the screws, and make sure they are all fully tightened. (Use the allen wrench to twist each screw until it is fully tightened.)



## ASSEMBLY INSTRUCTIONS

Tel.(562)-781-3327

Please contact us:[info@firstopintl.com](mailto:info@firstopintl.com)

<https://www.dreamsidea.com>