



ASSEMBLY INSTRUCTION

GLIDER RECLINING CHAIR

NOTE: Do not use power tools for assembly. Power tools increase the risk of over tightening which lead to splitting or cracking the wood.

COMPONENT LIST

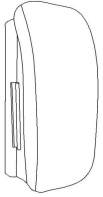
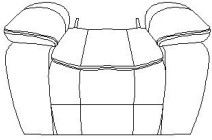
NO.	DRAWING	QTY	DESCRIPTION
A		1	LSF EAR
B		1	BACK REST
C		1	RSF EAR
D		1	SEAT

Please follow the drawings below to assemble the item.

Step 1. Use scissors to cut straps

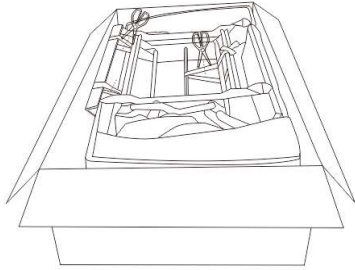

Step 2. Align the female brackets at the back rest onto the male brackets at the seat, insert and push to the end, make sure the brackets are secured in position.

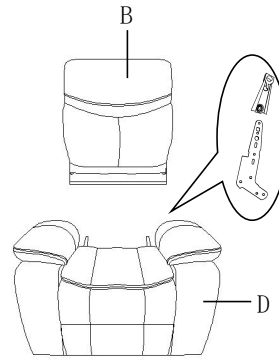

Step 3. Insert the LSF ear and RSF ear to the back rest and make sure it is secured in position.

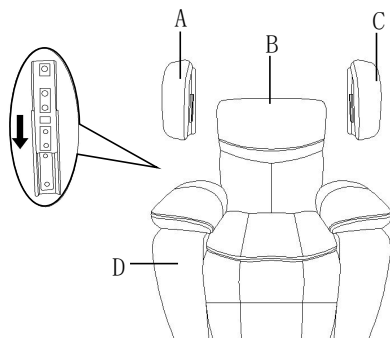

Step 4. Completed

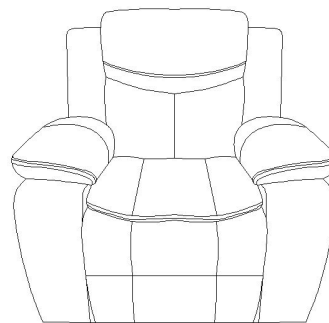

CARE INSTRUCTION FOR 8230BLK/BRW-1 (LEATHER GEL MATCH)

- **Avoid exposing furniture directly to sunlight or heating and air conditioning outlets. Exposure to sunlight or heating and air conditioning outlets will fade/damage leather gel match.**
- **Cleaning code : SW**
Spot clean with upholstery shampoo, foam from a mild detergent or a mild dry cleaning solvent. Do not saturate with liquid. Pile fabrics may require brushing to restore appearance. Cushion covers should not be removed and dry cleaned.

CARE INSTRUCTION FOR 8230FBR-1 (100% POLYESTER)

- **Avoid exposing furniture directly to sunlight or heating and air conditioning outlets. Exposure to sunlight or heating and air conditioning outlets will fade/damage 100% polyester.**
- **Cleaning code : S**
Clean only with a dry cleaning solvent. Do not saturate. Do not use water. Pile fabrics may require brushing to restore appearance. Cushion covers should not be removed and dry cleaned.



For items use on wooden floor, hard surfaces or carpets, it is recommended to install protective pads under all legs and supports to avoid/prevent from damages/scratches and discoloration

ASSEMBLY INSTRUCTION

DOUBLE GLIDER RECLINING LOVE SEAT WITH CONSOLE

NOTE: Do not use power tools for assembly. Power tools increase the risk of over tightening which lead to splitting or cracking the wood.

COMPONENT LIST

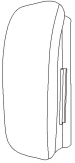
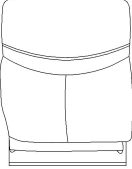
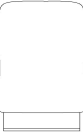
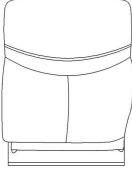
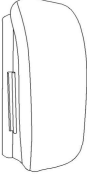
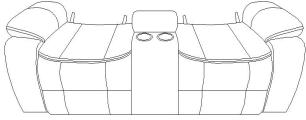
NO.	DRAWING	QTY	DESCRIPTION
A		1	LSF EAR
B		1	LSF BACK REST
C		1	CONSOLE BACK REST
D		1	RSF BACK REST
E		1	RSF EAR
F		1	SEAT

Please follow the drawings below to assemble the item.

Step 1. Use scissors to cut straps

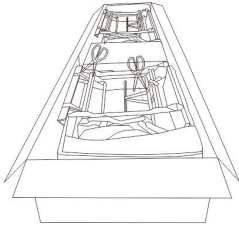

Step 2. Console back rest is stored at the lower back of the unit with a red string, please take out for assembly.

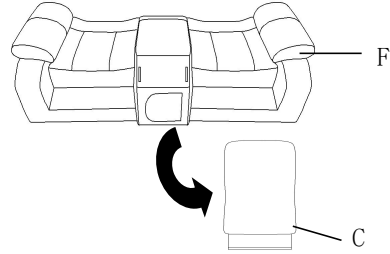

Step 3. Align the female brackets at the back rest onto the male brackets at the seat, insert and push to the end, make sure the brackets are secured in position.

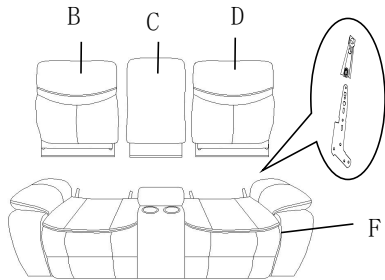

Step 4. Insert the LSF ear and RSF ear to the back rest and make sure it is secured in position.

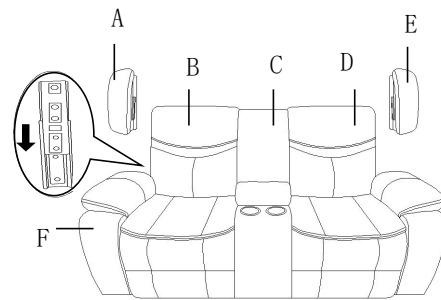

Step 5. Completed

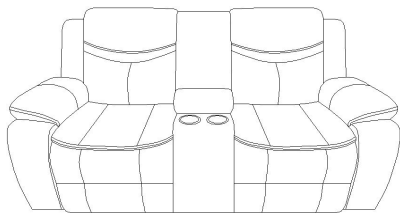

CARE INSTRUCTION FOR 8230BLK/BRW-2 (LEATHER GEL MATCH)

- **Avoid exposing furniture directly to sunlight or heating and air conditioning outlets. Exposure to sunlight or heating and air conditioning outlets will fade/damage leather gel match.**
- **Cleaning code : SW**
Spot clean with upholstery shampoo, foam from a mild detergent or a mild dry cleaning solvent. Do not saturate with liquid. Pile fabrics may require brushing to restore appearance. Cushion covers should not be removed and dry cleaned.

CARE INSTRUCTION FOR 8230FBR-2 (100% POLYESTER)

- **Avoid exposing furniture directly to sunlight or heating and air conditioning outlets. Exposure to sunlight or heating and air conditioning outlets will fade/damage 100% polyester.**
- **Cleaning code : S**
Clean only with a dry cleaning solvent. Do not saturate. Do not use water. Pile fabrics may require brushing to restore appearance. Cushion covers should not be removed and dry cleaned.



For items use on wooden floor, hard surfaces or carpets, it is recommended to install protective pads under all legs and supports to avoid/prevent from damages/scratches and discoloration

ASSEMBLY INSTRUCTION

DOUBLE RECLINING SOFA

NOTE: Do not use power tools for assembly. Power tools increase the risk of over tightening which lead to splitting or cracking the wood.

COMPONENT LIST

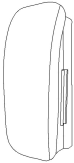
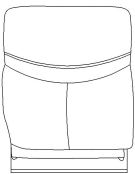
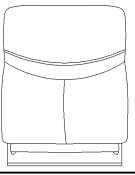
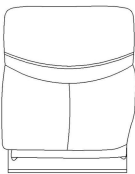
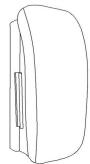
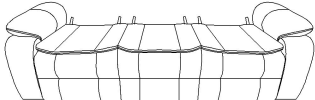
NO.	DRAWING	QTY	DESCRIPTION
A		1	LSF EAR
B		1	LSF BACK REST
C		1	MIDDLE BACK REST
D		1	RSF BACK REST
E		1	RSF EAR
F		1	SEAT

Please follow the drawings below to assemble the item.

Step 1. Align the female brackets at the back rest onto the male brackets at the seat, insert and push to the end, make sure the brackets are secured in position.

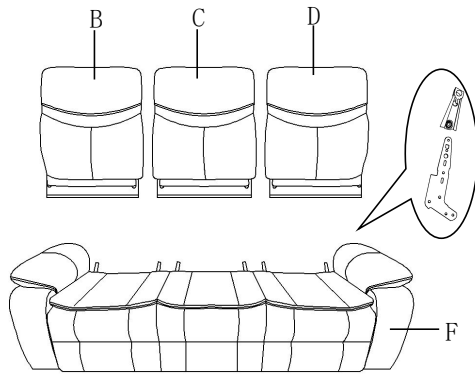

Step 2. Insert the LSF ear and RSF ear to the back rest and make sure it is secured in position.

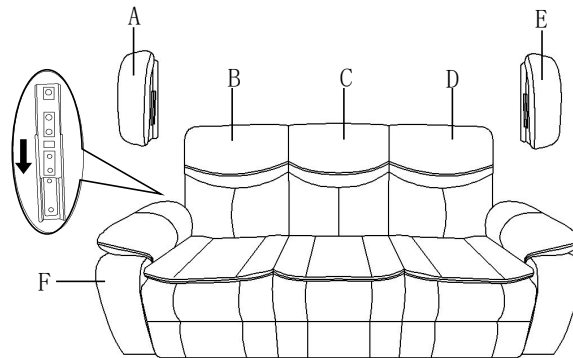

Step 3. Completed

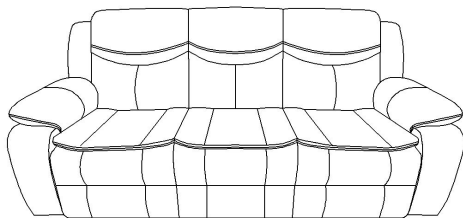

CARE INSTRUCTION FOR 8230BLK/BRW-3 (LEATHER GEL MATCH)

- **Avoid exposing furniture directly to sunlight or heating and air conditioning outlets. Exposure to sunlight or heating and air conditioning outlets will fade/damage leather gel match.**
- **Cleaning code : SW**
Spot clean with upholstery shampoo, foam from a mild detergent or a mild dry cleaning solvent. Do not saturate with liquid. Pile fabrics may require brushing to restore appearance. Cushion covers should not be removed and dry cleaned.

CARE INSTRUCTION FOR 8230FBR-3 (100% POLYESTER)

- **Avoid exposing furniture directly to sunlight or heating and air conditioning outlets. Exposure to sunlight or heating and air conditioning outlets will fade/damage 100% polyester.**
- **Cleaning code : S**
Clean only with a dry cleaning solvent. Do not saturate. Do not use water. Pile fabrics may require brushing to restore appearance. Cushion covers should not be removed and dry cleaned.



For items use on wooden floor, hard surfaces or carpets, it is recommended to Install protective pads under all legs and supports to avoid/prevent from damages/scratches and discoloration