

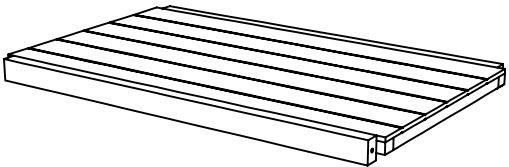









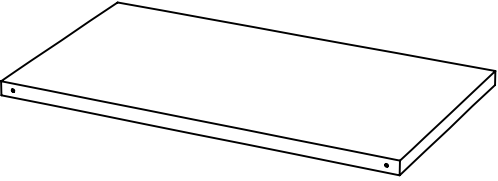
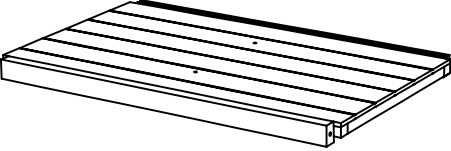
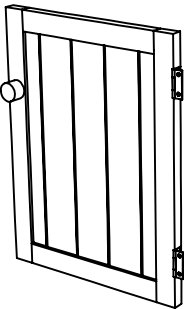

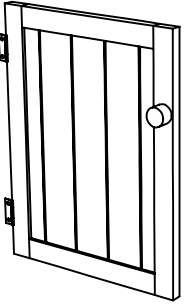
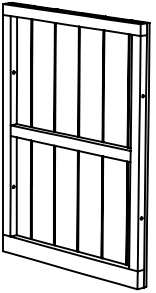
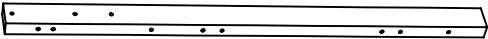
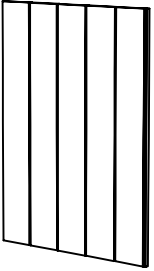
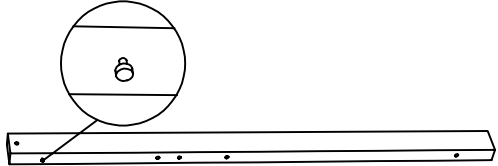
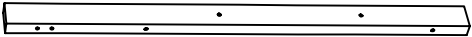
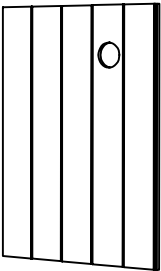
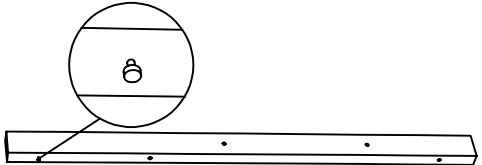
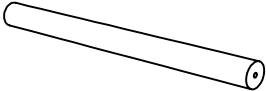
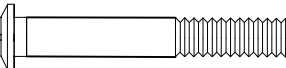
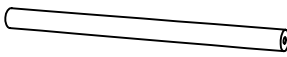

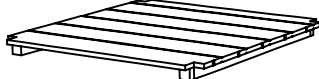

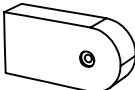

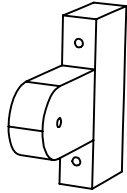
A		1PC	I		1PC
B		1PC	J		1PC
C		1PC	K		1PC
D		1PC	L		2PCS
E		1PC	M		1PC
F		1PC			
G		1PC	N		1PC
H		1PC			

O		1PC	DD	 M6*70 Bolt	14PCS
P		1PC	EE	 4*20 Screw	8PCS
Q		1PC	FF	 4*16 Screw	2PCS
R		2PCS	GG		1PC
S		1PC	HH		1PC
AA	 M6*20 Bolt	4PCS	II		2PCS
BB	 M6*40 Bolt	12PCS	JJ		2PCS
CC	 M6*45 Bolt	3PCS	 		

1

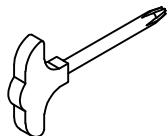
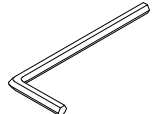
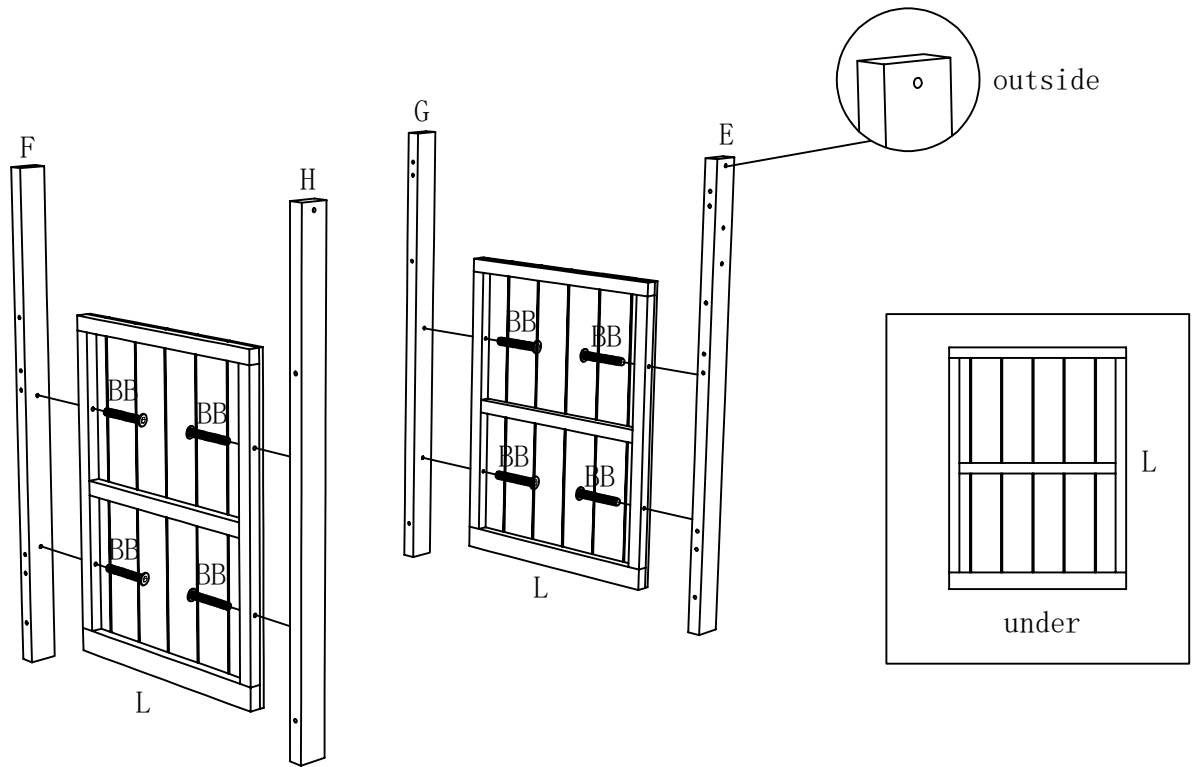

The wide side is downward facing.

2

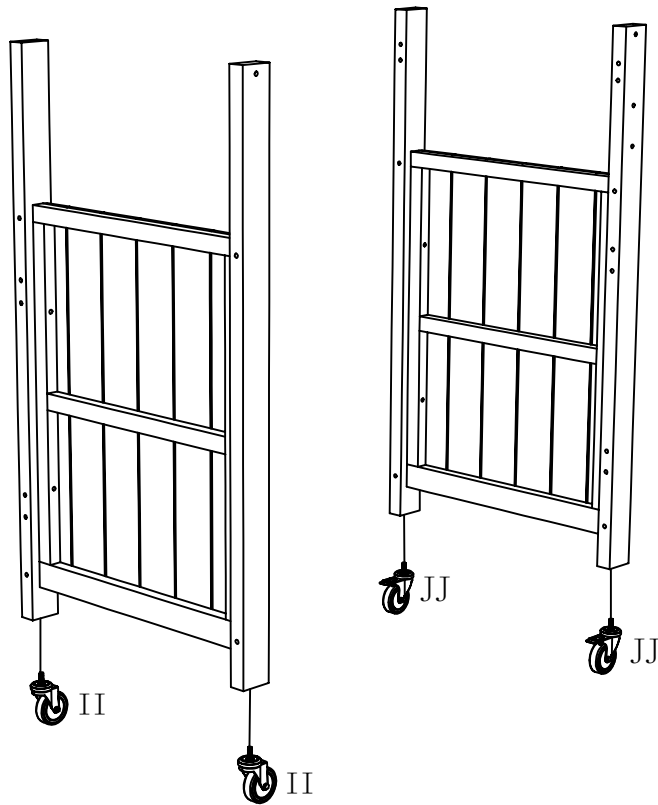

3

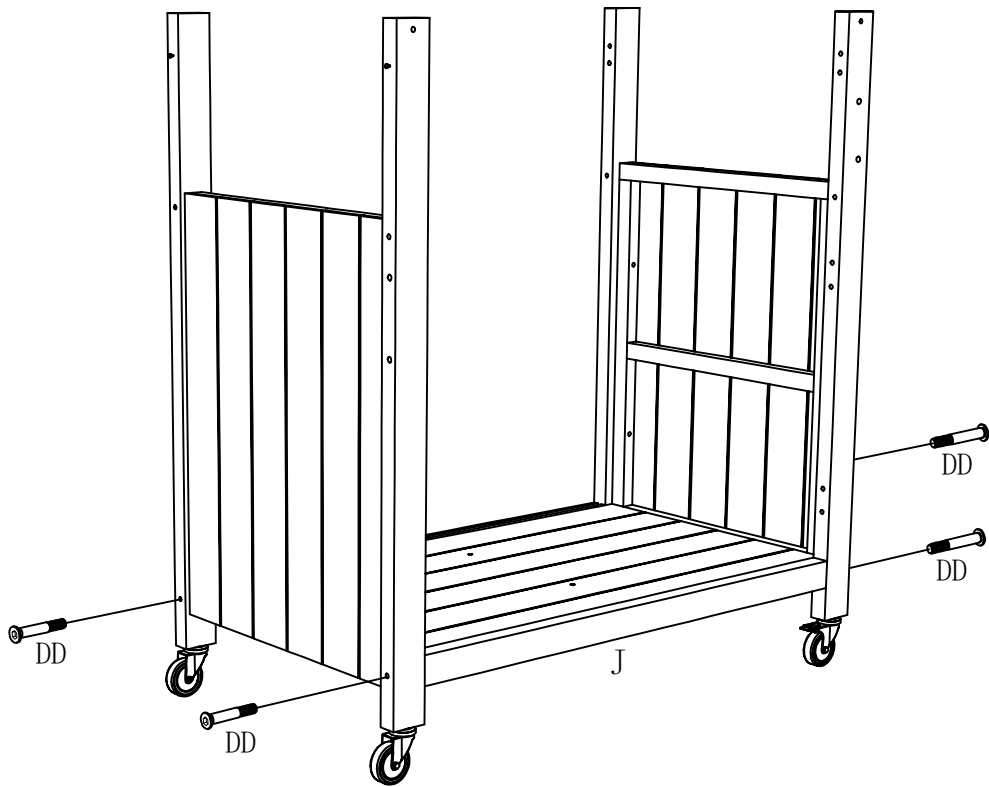

4



5

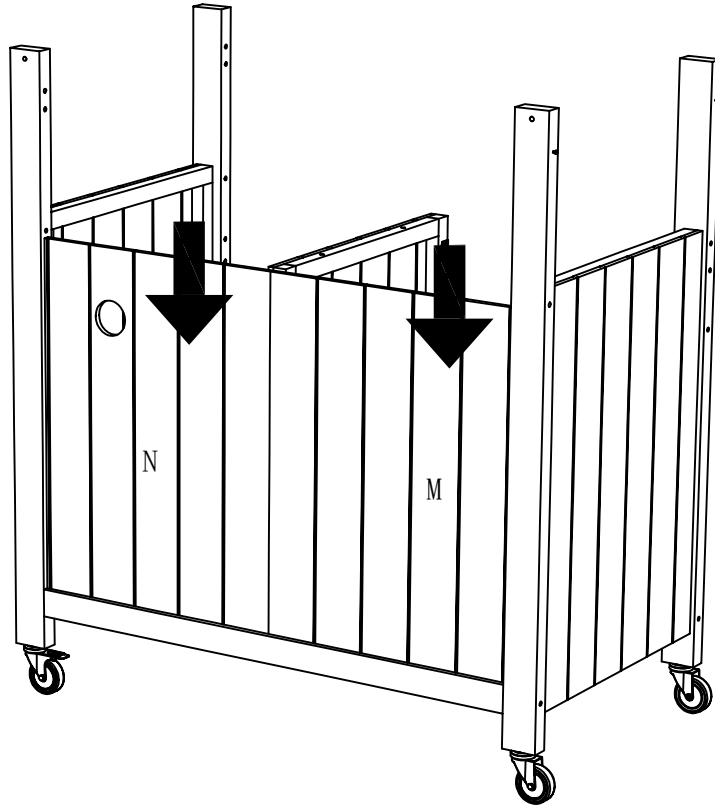

6

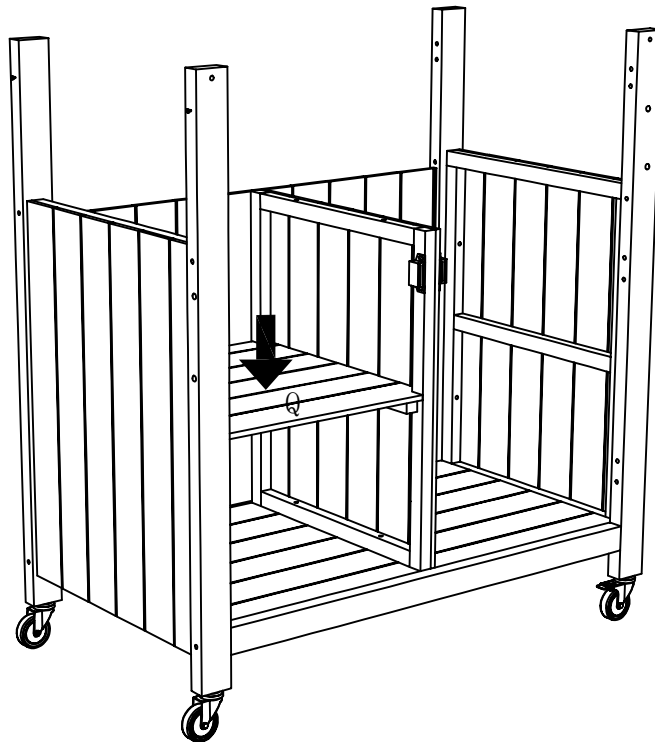

7

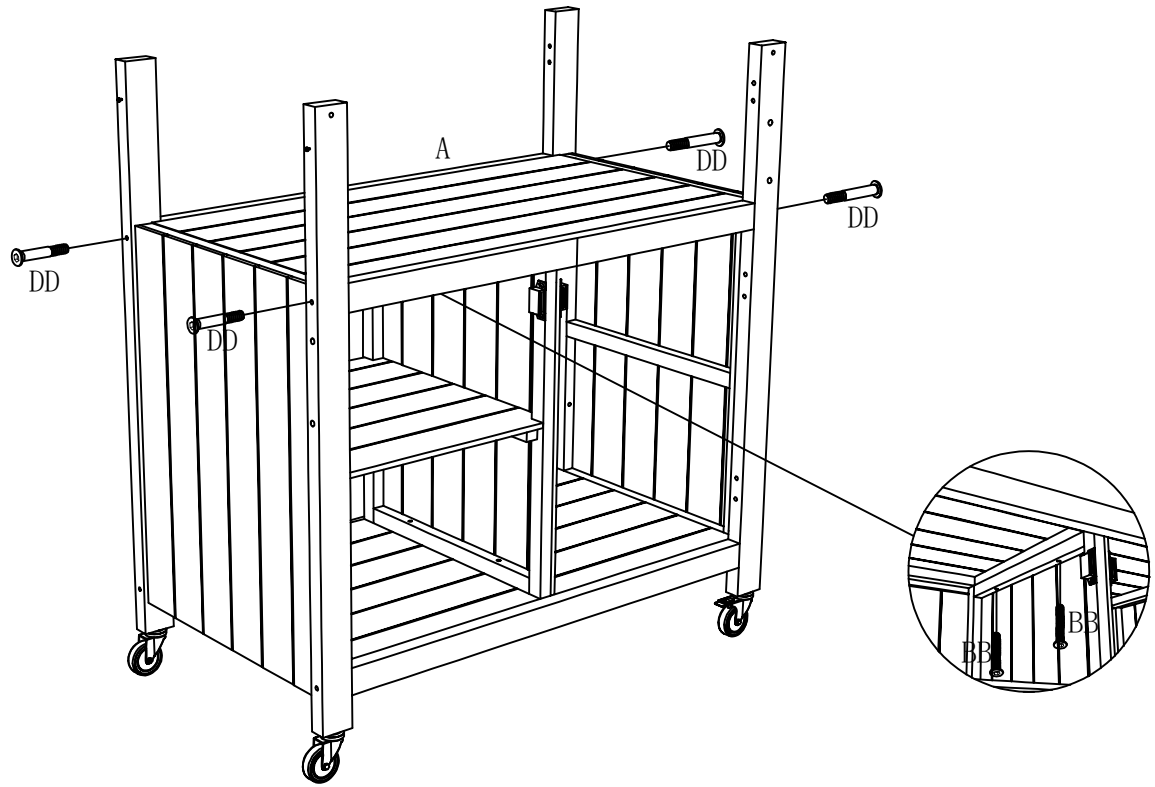

8

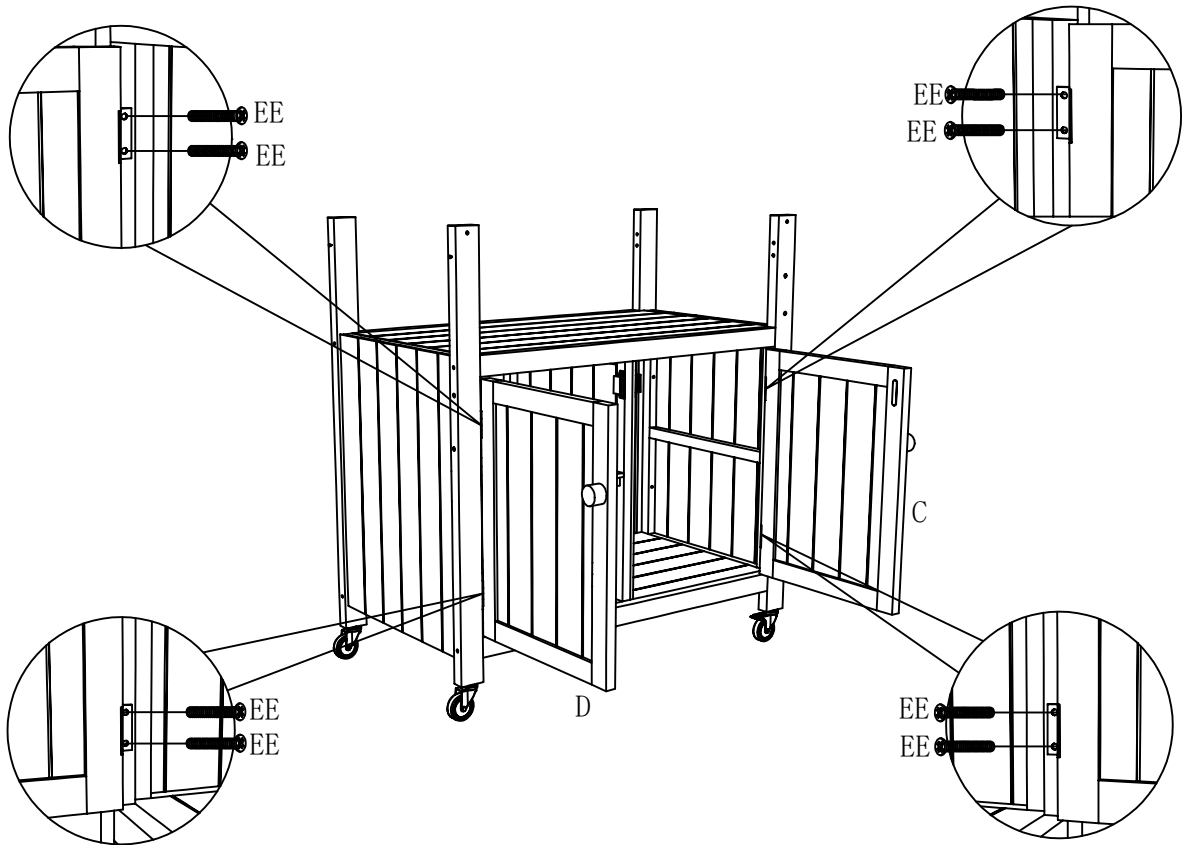

9

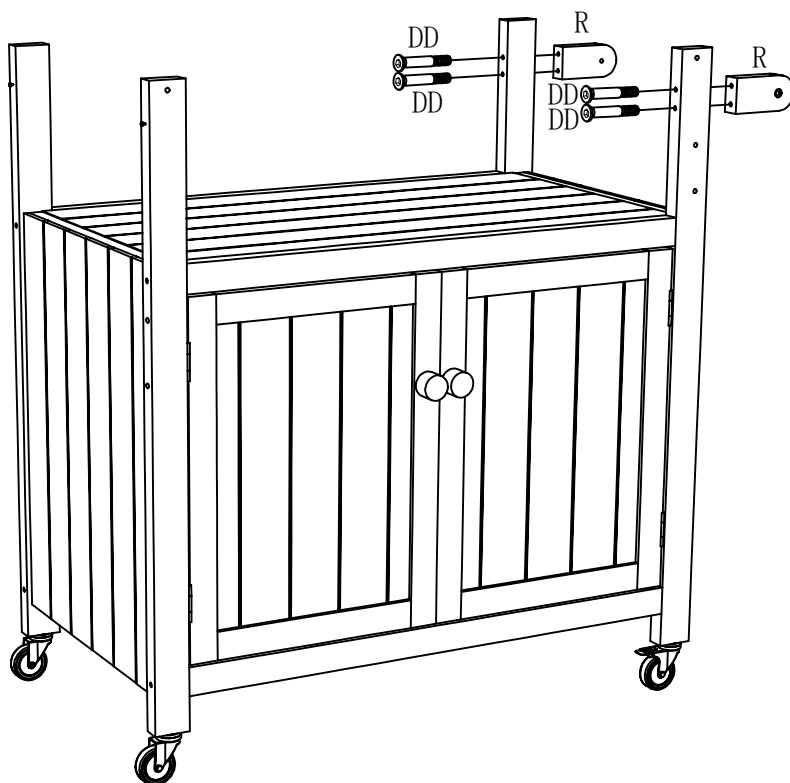

10

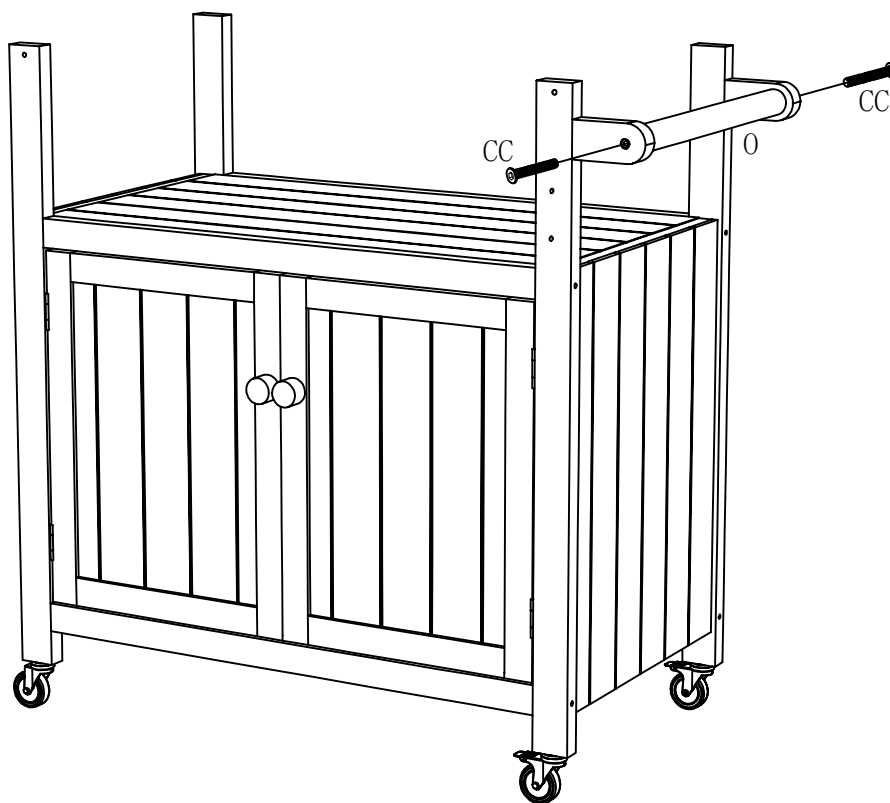

11

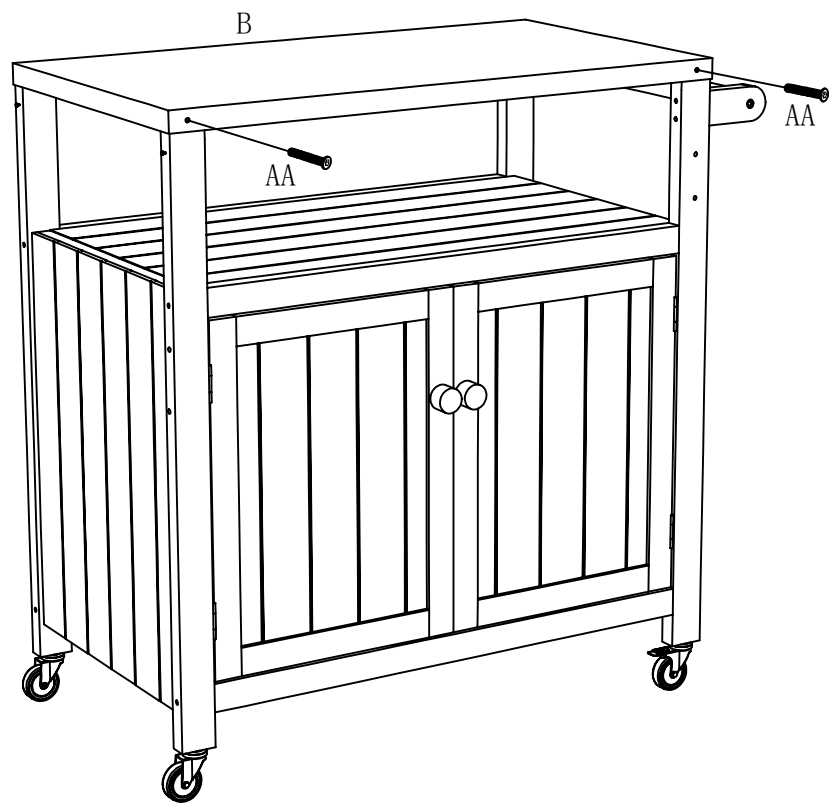

12

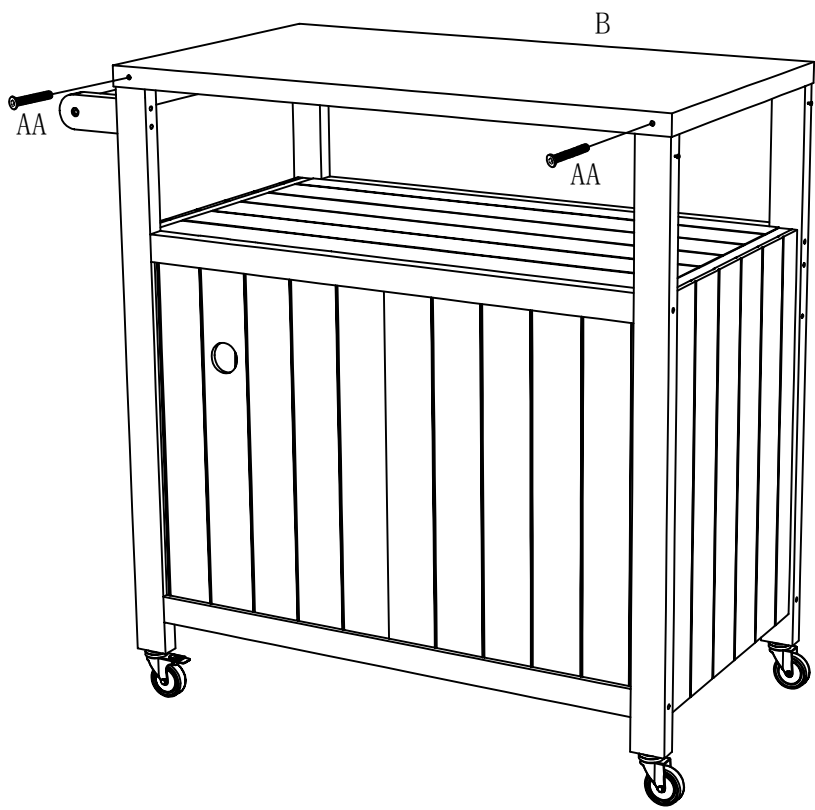

13

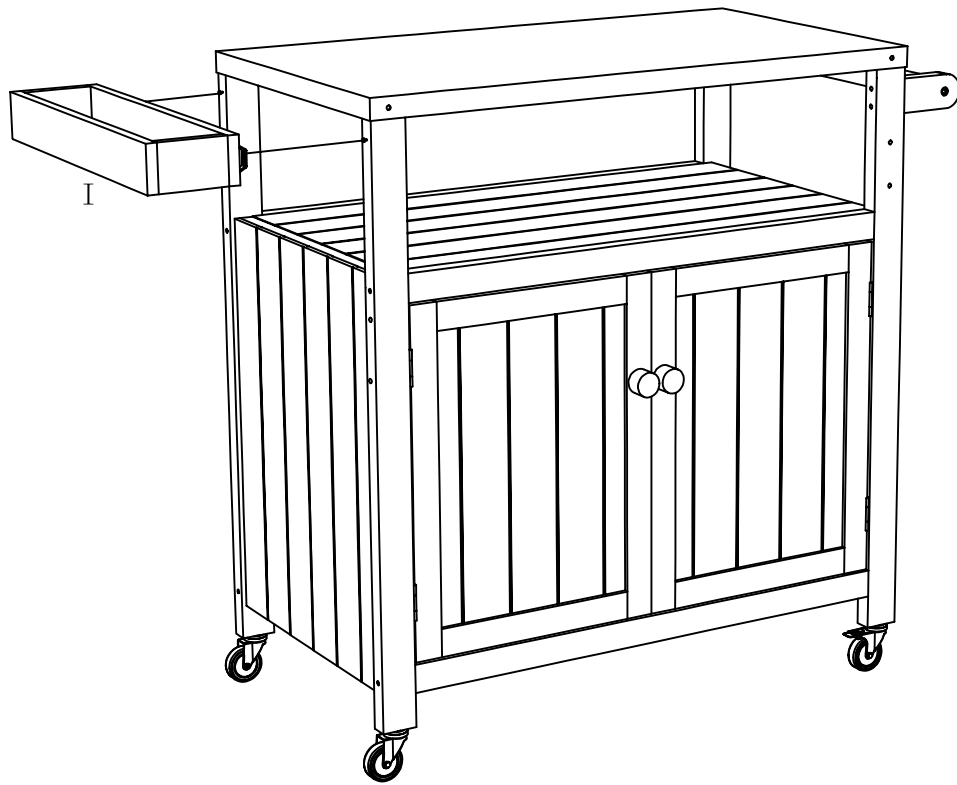

14



15

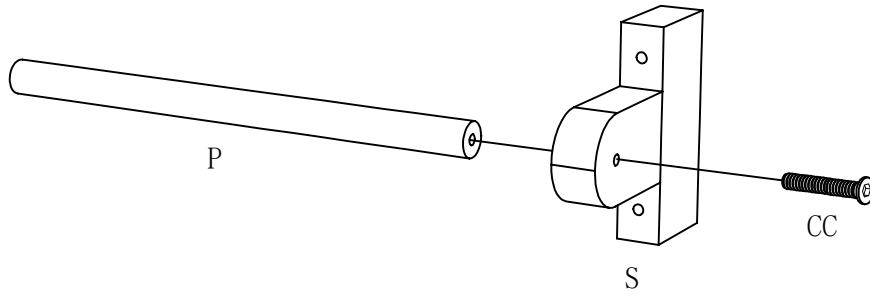

16



17



18

