

**EK/CK STORAGE HEADBOARD & FOOTBOARD /
TÊTE ET PIED DE LIT AVEC RANGEMENT EK/CK**











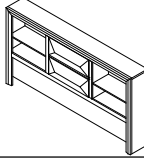
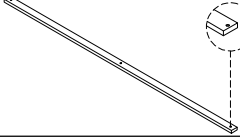

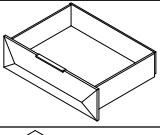

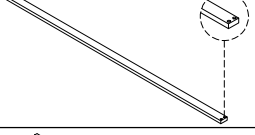

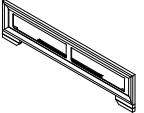

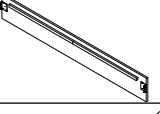

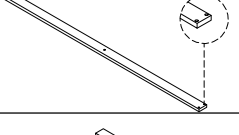
**QUEEN RAILS & CROSS BAR /
LONGERONS AVEC BARRE TRANSVERSALE ET COURONNE SUPÉRIEURE GRAND LIT**

**EK/CK SIZE BED DRAWERS /
TIROIRS DE CÔTÉ EK/CK**

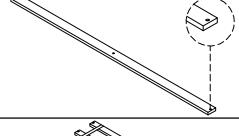
ASSEMBLY INSTRUCTIONS / INSTRUCTIONS D'ASSEMBLAGE

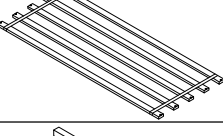
Thank you for purchasing this product. Please take time to read and follow the instructions below. Check that you have all parts and hardware before assembly. Parts apparently missing are often found in the packing materials. If you do not have all the parts listed, have your dealer contact us and they will be sent to you immediately.

Merci d'avoir acheté ce produit. Veuillez lire et suivre les instructions ci-dessous. Vérifiez avant le montage que vous avez toutes les pièces et fixations. Les pièces qui semblent manquer se trouvent souvent dans les matériaux d'emballage. Si vous n'avez pas toutes les pièces de la liste, demandez à votre détaillant et nous vous les enverrons immédiatement.

No.	PARTS LIST / LISTE DE PIÉCES		Qty.	No.	PARTS LIST / LISTE DE PIÉCES		Qty.
A		Headboard / Tête de lit	1	L		Center Rail / Longeron central	1
B		RSF Leg / Pied	1	M		Drawer / Tiroir	2
C		LSF Leg / Pied	1	N		Drawer Slat Cover / Couvert de latte de tiroir	1
D		Headboard Support Rail Front & Rear / Longeron de support avant et arrière pour tête de lit	2	O		Drawer Slat Support Stopper / Arrêt de latte de support pour tiroir	1
				No.	HARDWARE LIST / LISTE DE QUINCAILLERIE		Qty.
E		Footboard / Pied de lit	1	1		Screw / Vis (CSK M4 x 16mm)	7
F		Side Rail / Longerons	2	2		Screw / Vis (CSK M4 x 32mm)	38
G		Drawer Slat / Latte de tiroir	1	3		Bolt / Boulon (35mm)	8
H		Drawer Slat Support / Latte de support pour tiroir	1	4		Bolt / Boulon (50mm)	3
I		Slat 3 Holes / Latte 3 trous	3	5		Spring Washer / Rondelle d'arrêt (Ø¼")	8
J		Slat 2 Holes / Latte 2 trous	10	6		Flat Washer / Rondelle plate (Ø¼" x 20mm)	8
K		Support Leg / Support pour transverses	3	7		Allen Key / Clé Allen (M4)	1
				8		Allen Key / Clé Allen (M5)	1

*



It is recommended to install protective pads under all legs and supports to avoid damage or scratches when placing furniture on a wood floor or other hard surface, and to limit indentation and prevent discoloration if placing on carpet.



Il est recommandé de placer des coussins protecteurs sous tous les pieds et toutes les bases des meubles pour éviter d'endommager ou d'égratigner les planchers en bois ou autres surfaces dures, et pour limiter l'empreinte et empêcher la décoloration quand les meubles reposent sur la moquette.

TIPS :
Lay down the unit. To make
the installation work easier.

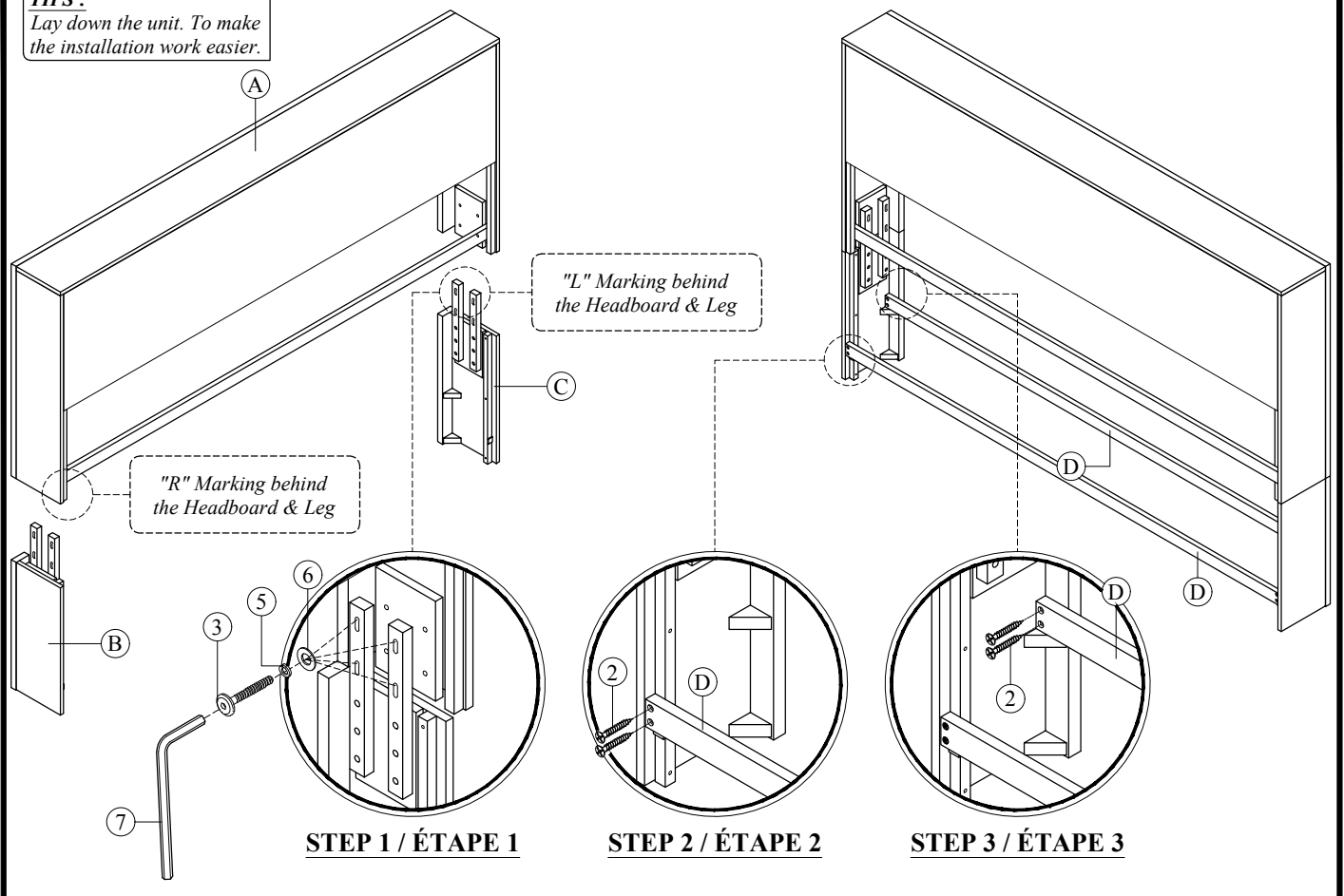

STEP 4 / ÉTAPE 4

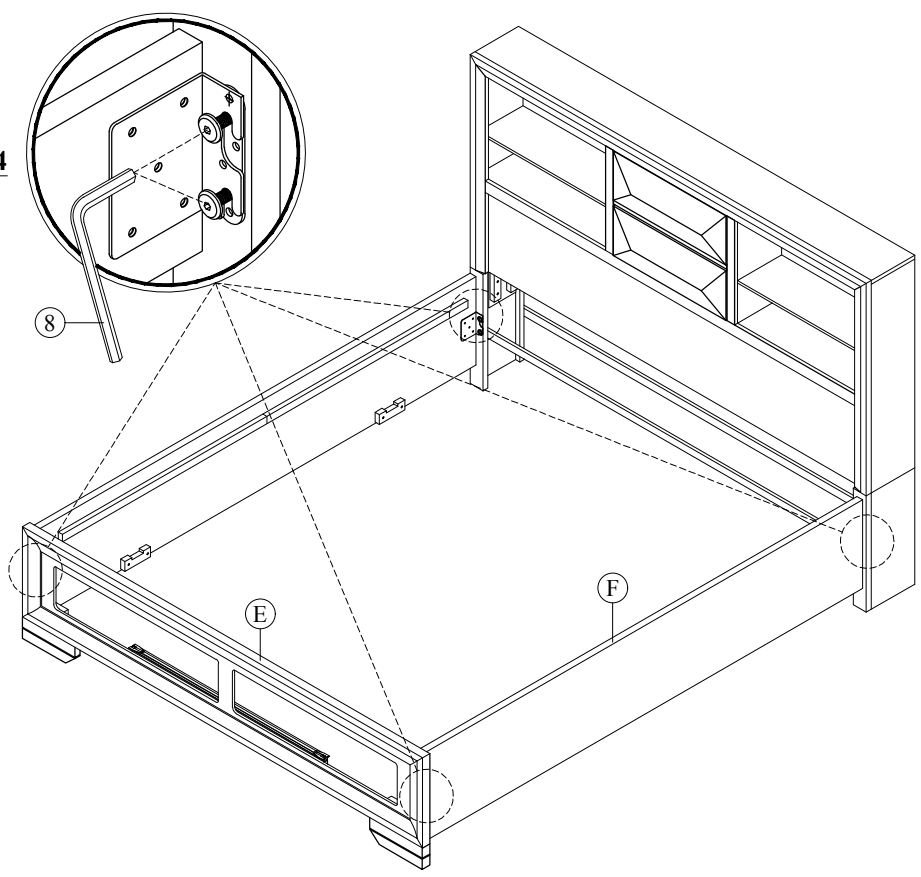

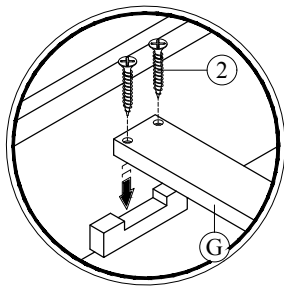

STEP 6 / ÉTAPE 6

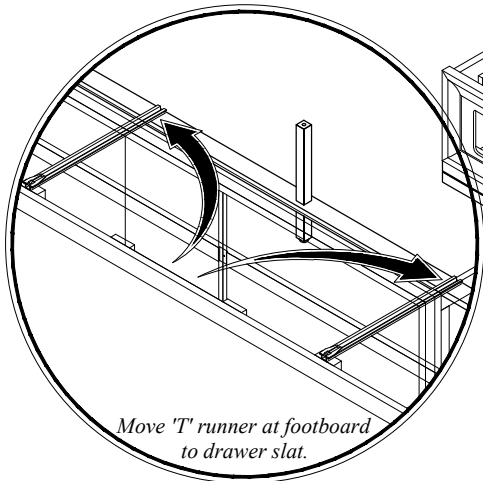

Move 'T' runner at footboard to drawer slat.

STEP 7 / ÉTAPE 7

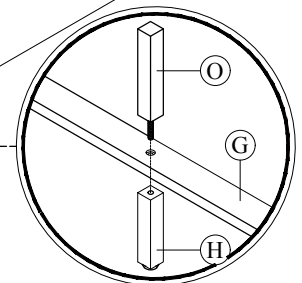

STEP 5 / ÉTAPE 5

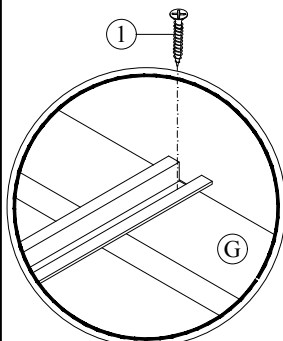

After insert the drawer please fasten the T-Runner on the drawer slat with screw.

STEP 9 / ÉTAPE 9

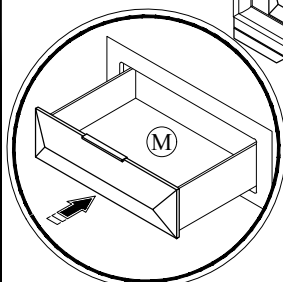

STEP 8 / ÉTAPE 8

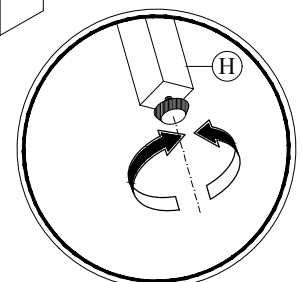

Adjust the leveler until the drawer closes tightly.

STEP 10 / ÉTAPE 10

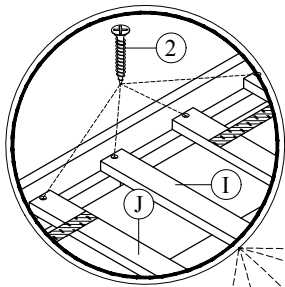

STEP 13 / ÉTAPE 13

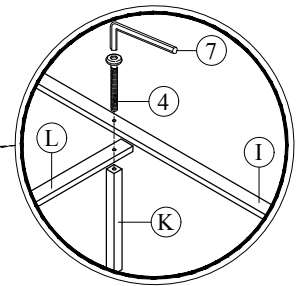

STEP 11 / ÉTAPE 11

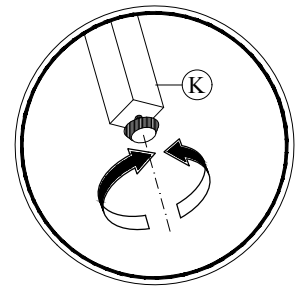

STEP 12 / ÉTAPE 12

Adjust the leveler until touch the floor.

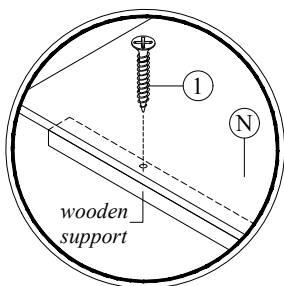
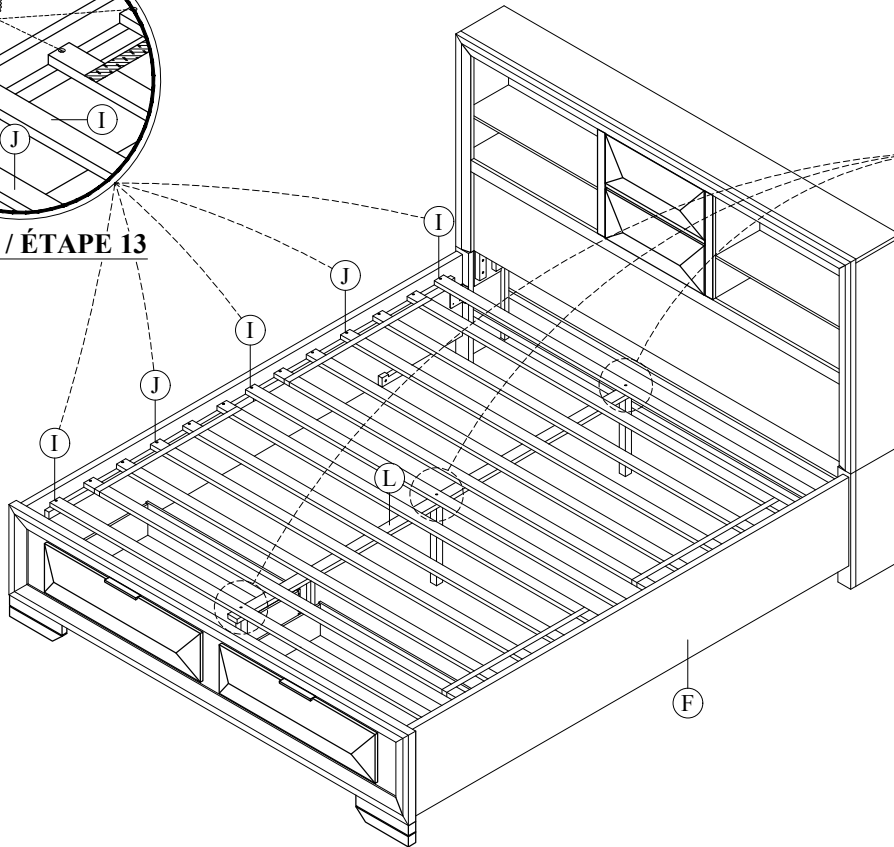

STEP 14 / ÉTAPE 14

Close the drawer slat cover to the back of the footboard. Then, fasten the drawer slat cover on the wooden support using screws.

