







Part No.	Part	Qty	Image	Part No.	Part	Qty	Image
A	Top	1		B	Shelf	1	
C	Leg	4		D	Bolt	12	 M6 * 15MM
E	Wahser	12		F	Hex Wrench	1	

STEP 1

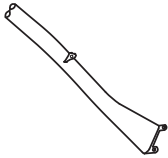

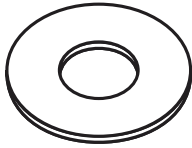
STEP 2

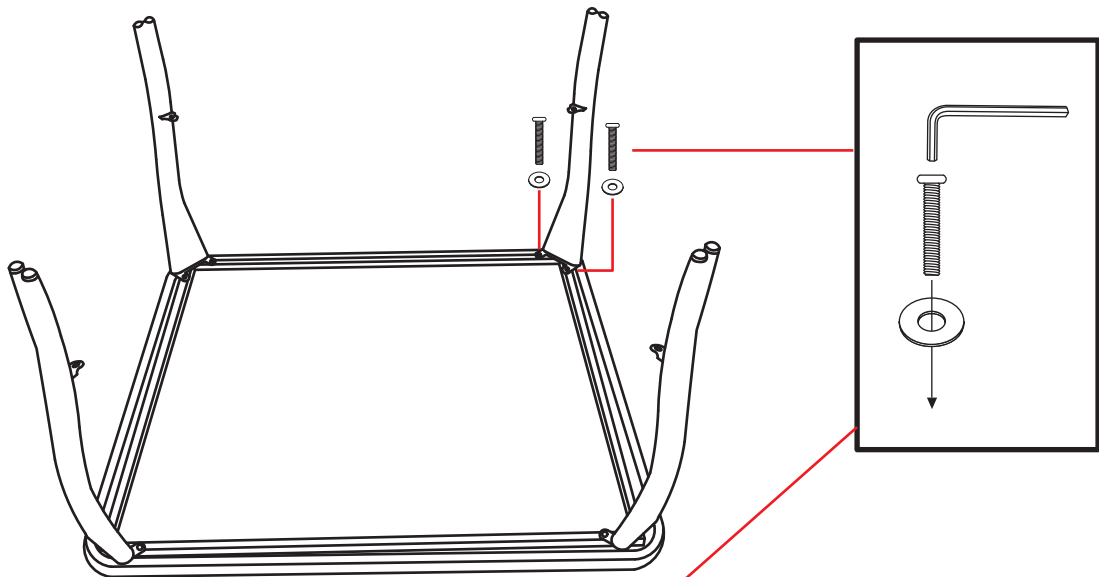