

NOTICE

*Please make sure that you have all parts indicated and they are in good condition before you begin assembly of this item. Refer to part list and hardware list below for guidance.

*This item should be assembled on a soft surface to prevent scratching the finish during assembly.

*This item may require periodic tightening.

*If you are having difficulty, our friendly Customer Care team is always here to help. Please email customersupport@safavieh.com.

PREPARATION

* Before beginning assembly of product, make sure all parts are present. Compare parts with part contents list and hardware contents list.

* If any part is missing or damaged, do not attempt to assemble the product.







* Estimated Assembly Time: 10 minutes.

* **Tools Required for Assembly (included): Allen Key**

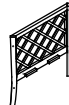
CARE AND MAINTENANCE

Insert Care and Maintenance here

Part List and Hardware List

PIECE	DESCRIPTION	PICTURE	QUANTITY
A	Back Frame		1X
B	Frame Seat		1X
C	Leg Frame		2X
D	Cross Leg		1X
CSH1	Seat Cushion		1X
CSH2	Back Cushion		1X
HW1	Allen Bolt: M6x0.5x35 mm	 M6x35 mm	2X

SAFAVIEH C O U T U R E

Model# CPT1036A



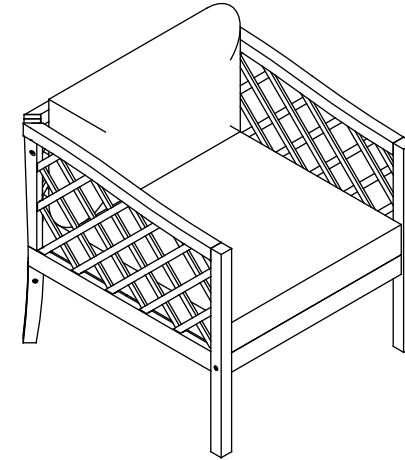

Product Dimensions: 29.13" W x 31.1" D x 28.74" H



Weight Capacity : 200 Ibs

Warning : Do not stand on bench

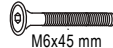
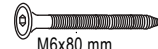
Warning : Do not over torque bolts / screws

HW2	Allen Bolt: M6x0.5x50 mm	 M6x50 mm	2X
HW3	Insert Nut	 M6x15	4X
HW4	Screws M6x0.5x45 mm	 M6x45 mm	4X
HW5	Screws M6x0.5x80 mm	 M6x80 mm	2X
HW6	Allen key	 LG4	2X

PREPARATION

- *Before beginning assembly of product, make sure all parts are present. Compare parts with package contents list and hardware contents list.
- *If any part is missing or damaged, do not attempt to assemble the product.
- * Estimated Assembly Time : 10 minutes.
- * Tools Required for Assembly (included): Allen Key
- * If you are having difficulty, our friendly Customer care team is always here to help. Please email customersupport@safavieh.com

1

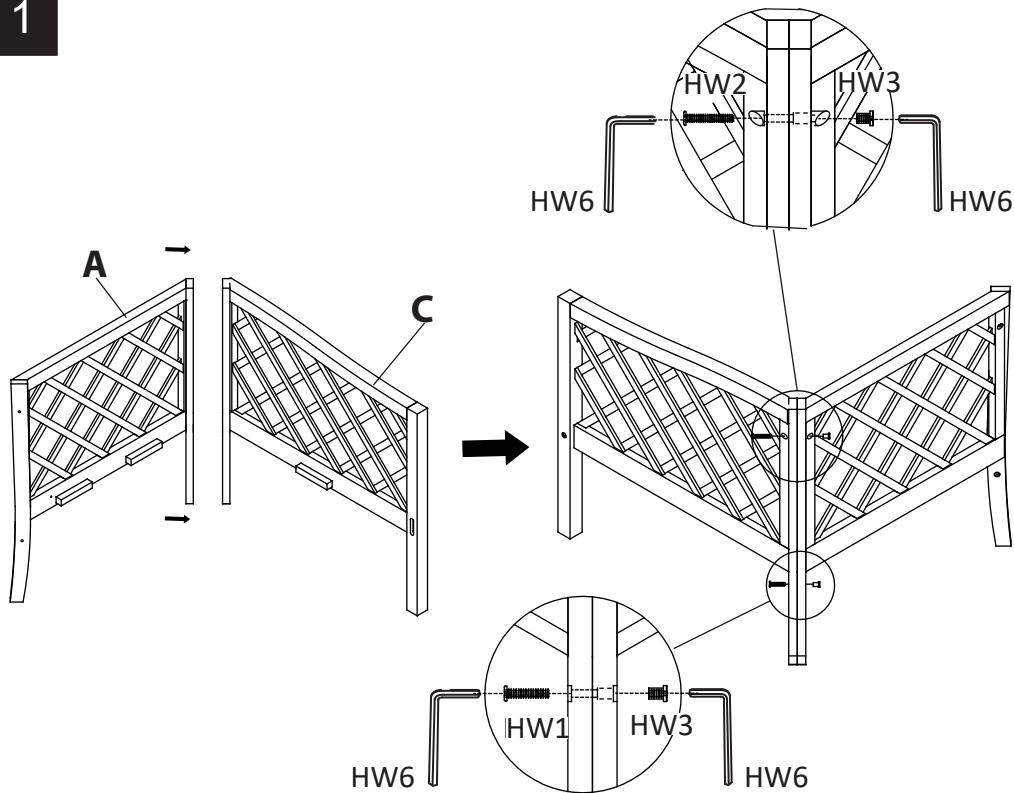

Step 1

Attach Back Frame (A) to Frame Leg (C), use Bolts (HW1) , Bolts (HW2) and Insert Nut (HW3) tighten with Allen Key (HW6)

2

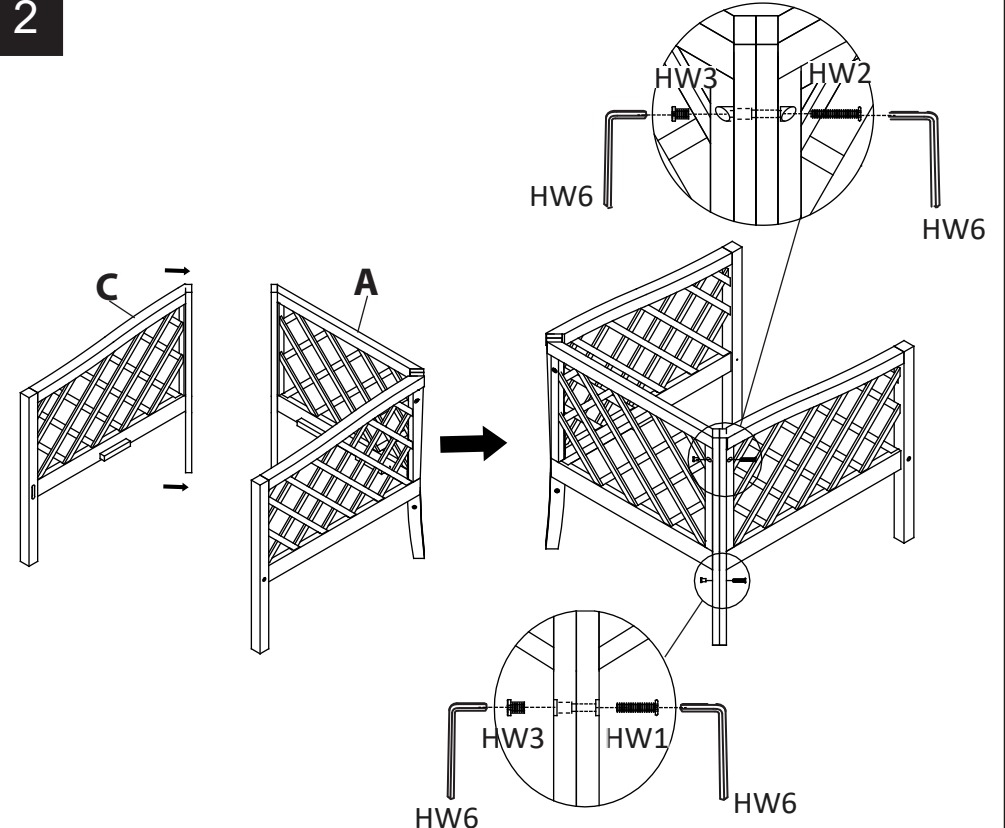

Step 2

Attach Frame Leg (C) to Back Frame (A), use Bolts (HW1) , Bolts (HW2) and Insert Nut (HW3) tighten with Allen Key (HW6)

PREPARATION

- *Before beginning assembly of product, make sure all parts are present. Compare parts with package contents list and hardware contents list.
- *If any part is missing or damaged, do not attempt to assemble the product.
- * Estimated Assembly Time : 10 minutes.
- * Tools Required for Assembly (included): Allen Key
- * If you are having difficulty, our friendly Customer care team is always here to help. Please email customersupport@safavieh.com

3

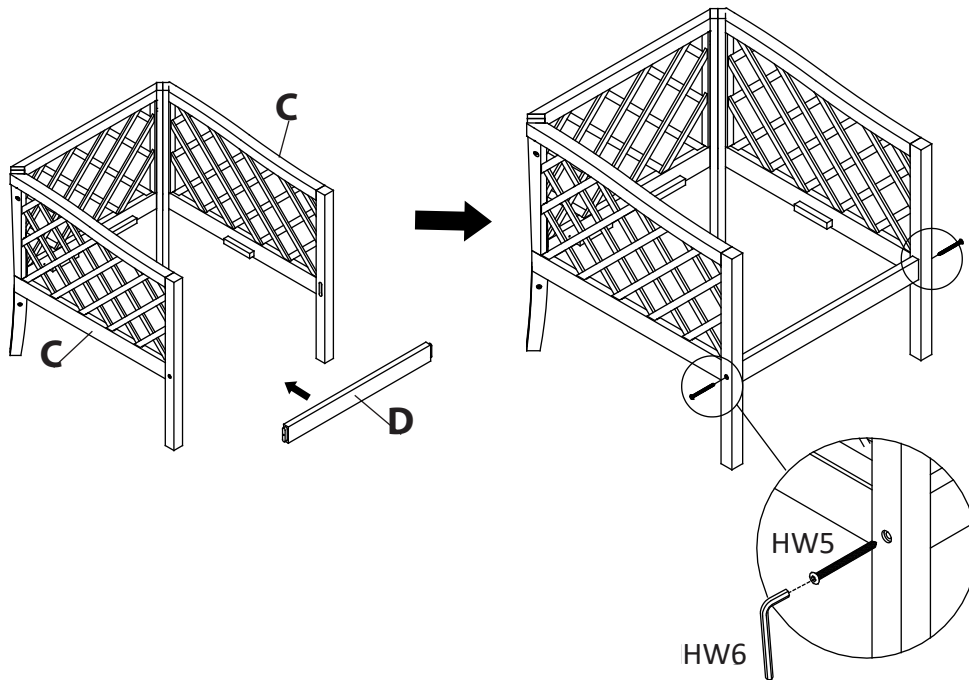

Step 3

Attach Cross Leg (D) to the assembled frame in step 2 , use Screws (HW5) tighten with Allen Key (HW6)

4

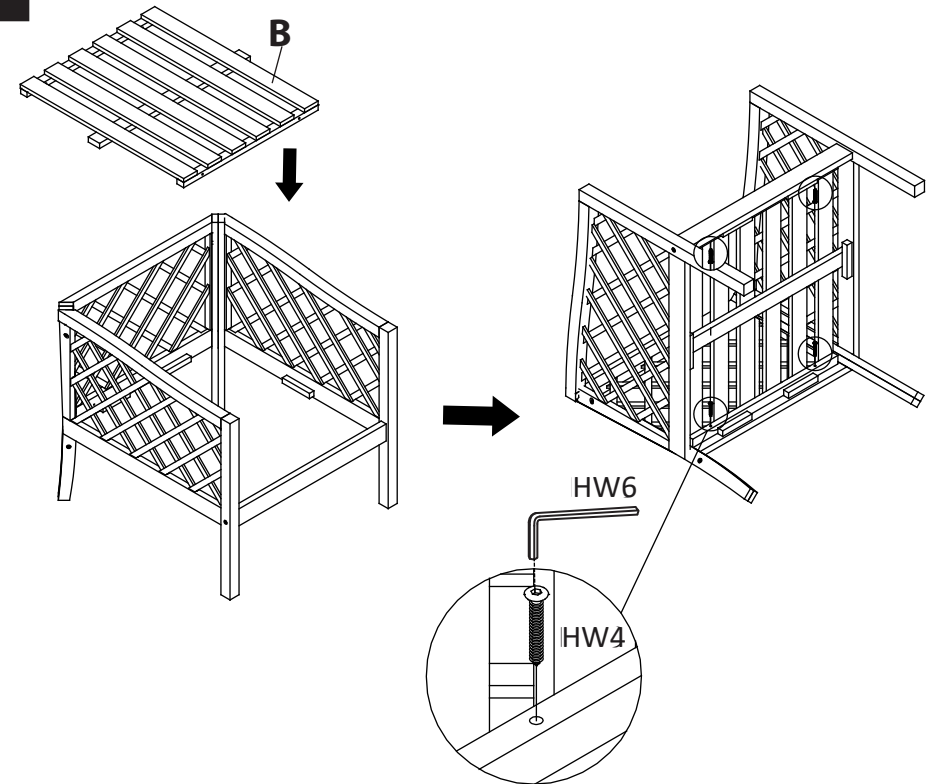

Step 4

Attach Frame Seat (B) to the assembled frame in step 3 , use Screws (HW4) tighten with Allen Key (HW6)

PREPARATION

- *Before beginning assembly of product, make sure all parts are present. Compare parts with package contents list and hardware contents list.
- *If any part is missing or damaged, do not attempt to assemble the product.
- * Estimated Assembly Time : 10 minutes.
- * Tools Required for Assembly (included): Allen Key
- * If you are having difficulty, our friendly Customer care team is always here to help. Please email customersupport@safavieh.com

5

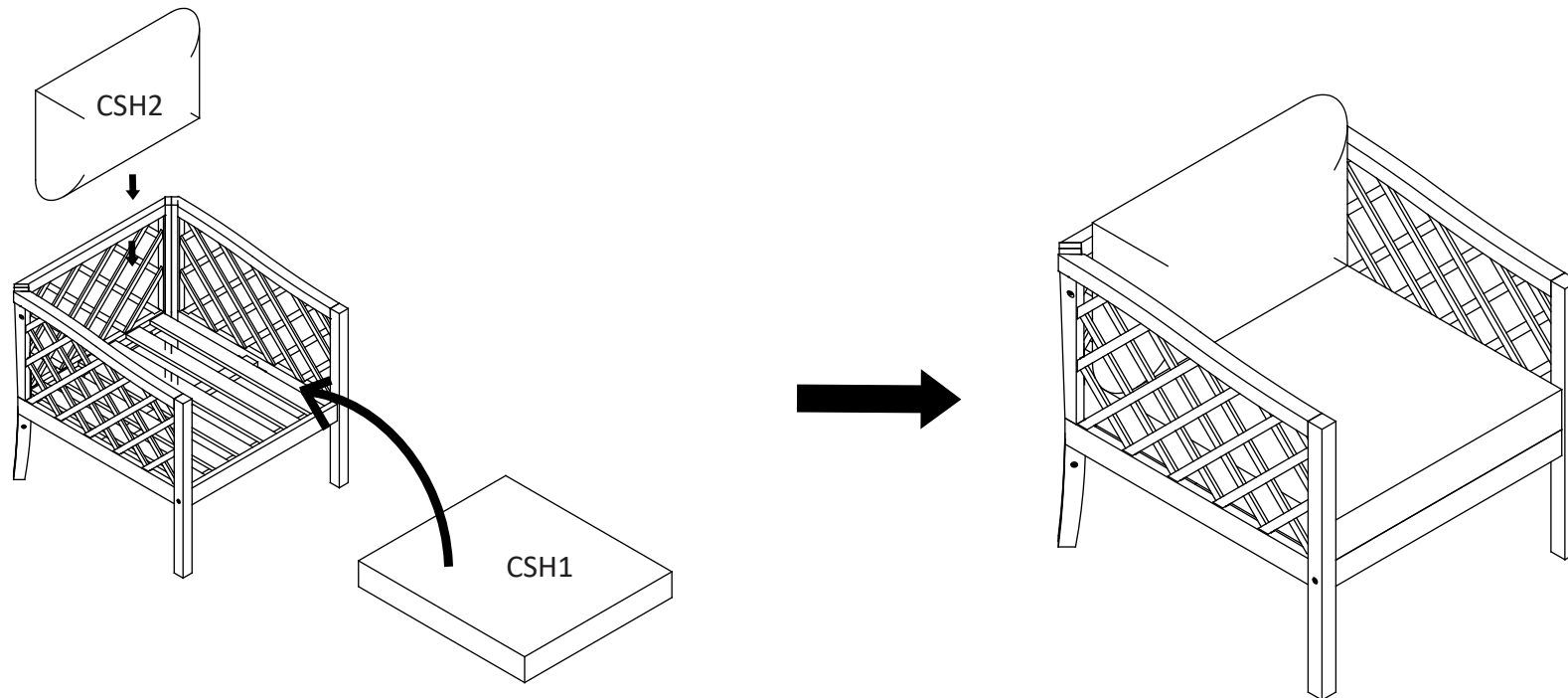

Step 5

Attach Ensure all screws, bolts are fully locked into position . Place Seat Cushion (CSH1), Back Cushion (CSH2) into the Chair.
The Chair is ready to be used