

Installation & Assembly

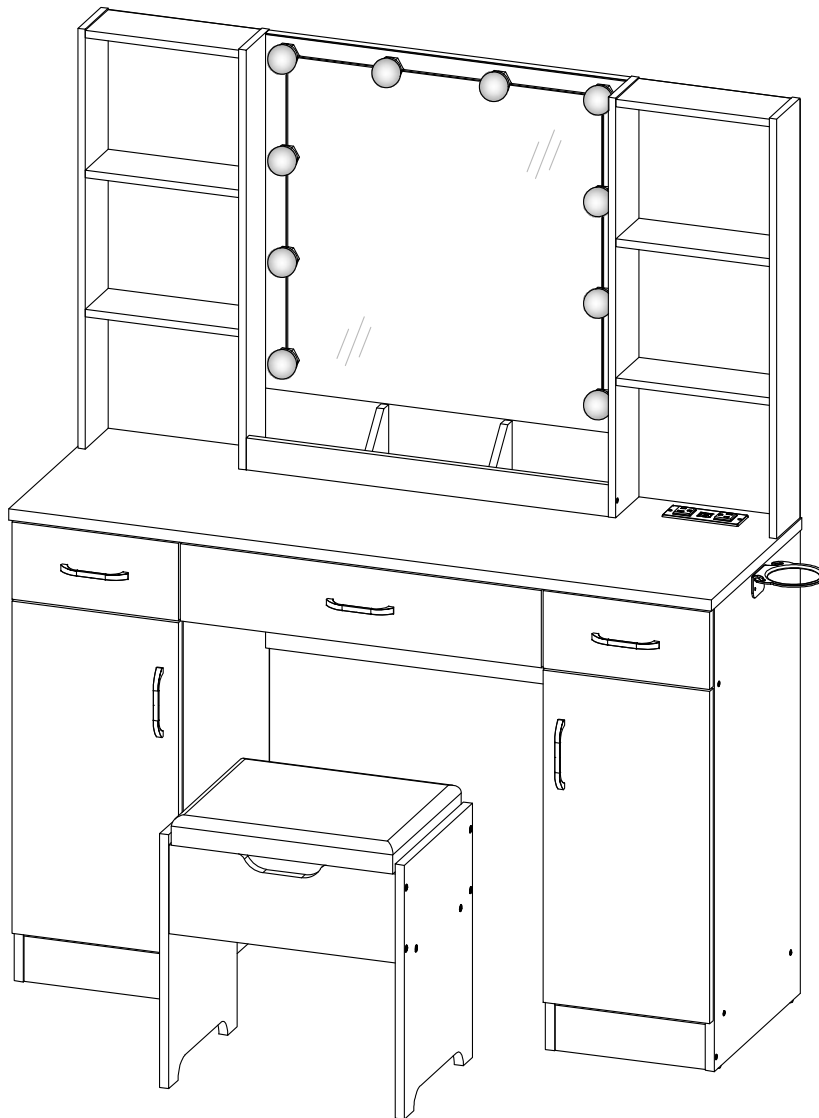

As this item contains many parts, please read the installation instruction carefully before installation. Please use tools properly and carefully. If you have any questions about the product and installation, please contact us.

Our professional after-sales team will serve you online all day.

Before You Start

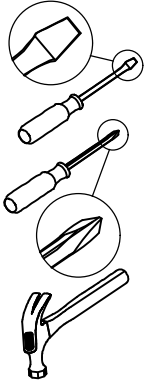

- ✓ Read through each step carefully and follow the proper order
- ✓ Separate and count all your parts and hardware
- ✓ Give yourself enough room for the assembly process
- ✓ Have the following tools: Flat Head Screwdriver, #2 Phillips Head Screwdriver and Hammer
- ✓ Caution: If using a power drill or power screwdriver for screwing, please be aware of to slow down and stop when screw is tight. Failure to do so may result in stripping the screw. (Assembly speed can be increased by using electric screwdriver)

Helpful Hints

PEOPLE NEEDED FOR ASSEMBLY: 1-2

- Open your item in the area you plan to keep it to avoid excessive heavy lifting.
- Identify, sort and count the parts before attempting assembly.
- Compression dowels are lightly tapped in with a hammer.
- Slides are labeled with an **R** (right) and **L** (left) for proper placement.
- Make sure to always face the point on the top of the Cam Lock towards the outer edge.
- If there is a back panel in the package, please install it to make sure your unit is complete and sturdy.
- Please fix all the screws provided for the back panel which can enhance product stability. If it is difficult to fix it when tightening, it can be fixed with the help of a hammer and then tightened.
- Do NOT use harsh chemicals or abrasive cleaners on this item.
- Never push, pull, or drag your furniture.



Board Identification

Not actual size

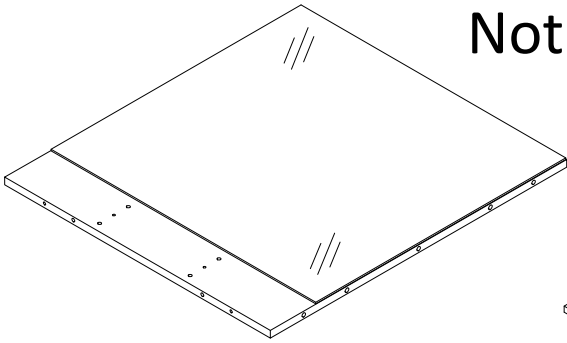

(A)

DRESSING MIRROR
Qty:1

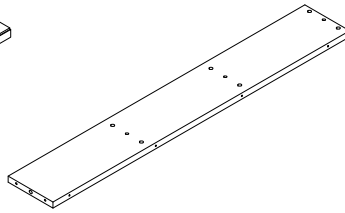

(B)

UPPER LEFT SIDE PANEL
Qty:1

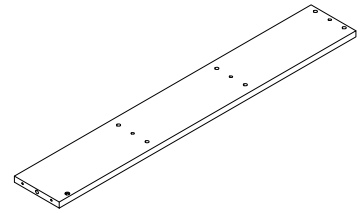

(C)

UPPER LEFT PARTITION
Qty:1

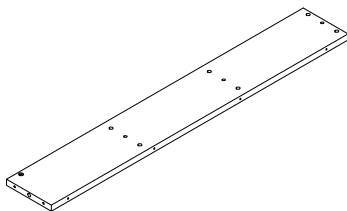

(D)

UPPER RIGHT PARTITION
Qty:1

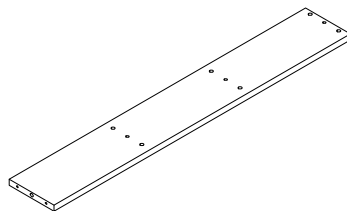

(E)

UPPER RIGHT SIDE PANEL
Qty:1

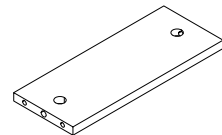

(F)

FIXED SHELF
Qty:6

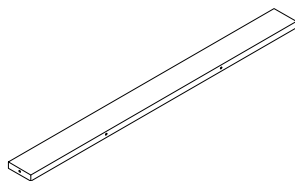

(G)

FRONT BAFFLE
Qty:1

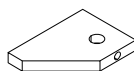

(H)

SMALL PARTITION
Qty:2

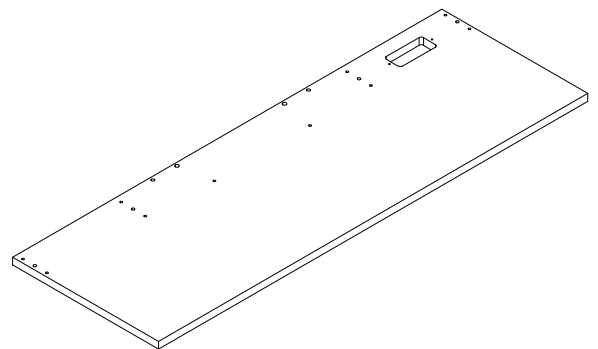

(I)

DESK TOP
Qty:1

Board Identification

Not actual size

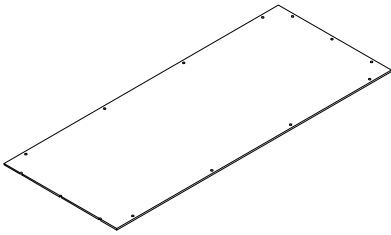

ⓐ

BACK PANEL
Qty:3

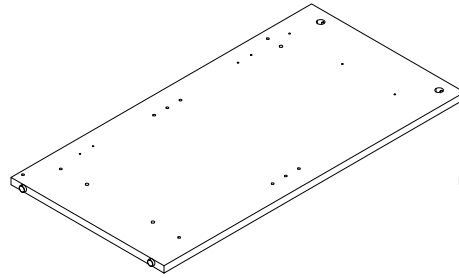

ⓑ

LOWER LEFT SIDE PANEL
Qty:1

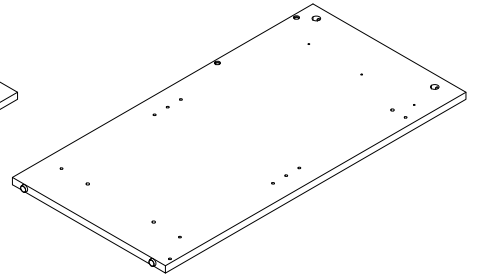

ⓒ

LOWER LEFT PARTITION
Qty:1

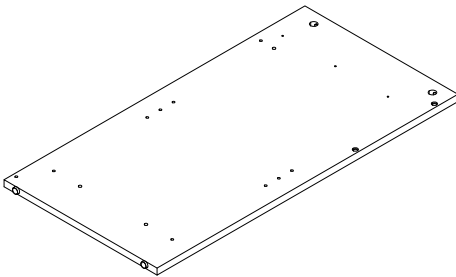

ⓓ

LOWER RIGHT PARTITION
Qty:1

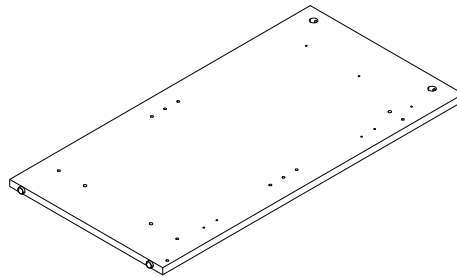

ⓔ

LOWER RIGHT SIDE PANEL
Qty:1

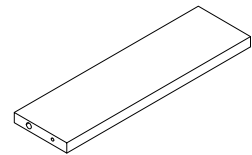

ⓕ

SIDE SLAT UNDER DRAWER
Qty:2

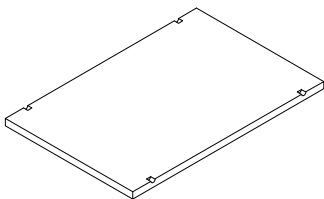

ⓖ

ADJUSTABLE SHELF
Qty:2

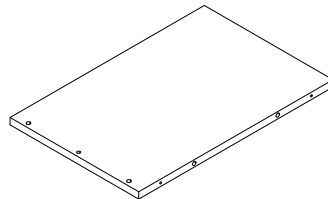

ⓗ

BOTTOM
Qty:2

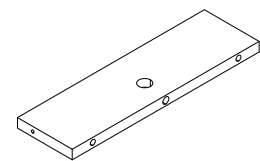

ⓘ

BOTTOM FRONT RAIL
Qty:2

Board Identification

Not actual size

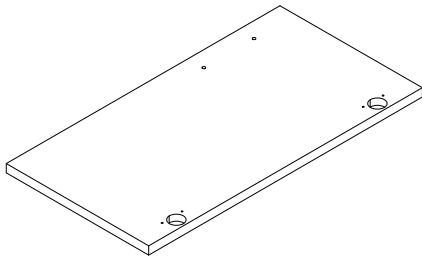

Ⓢ

LEFT DOOR
Qty:1

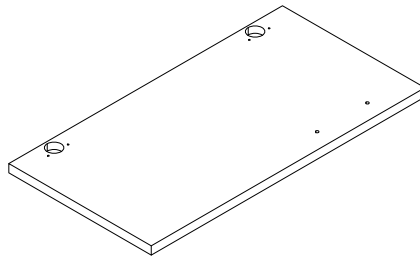

Ⓣ

RIGHT DOOR
Qty:1

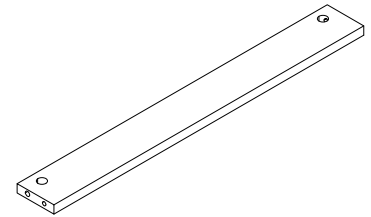

Ⓤ

MIDDLE SLAT UNDER DRAWER
Qty:1

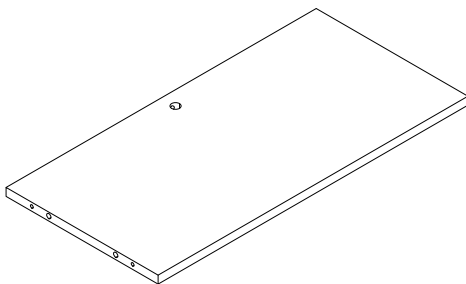

Ⓥ

LOWER MIDDLE BACK
Qty:1

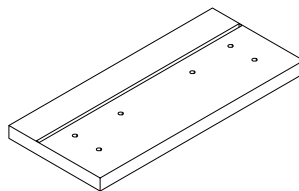

Ⓦ

DRAWER FRONT
Qty:2

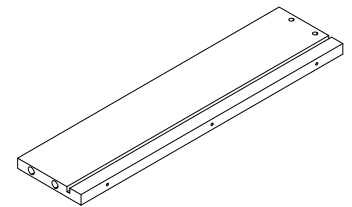

Ⓧ

DRAWER LEFT SIDE
Qty:1

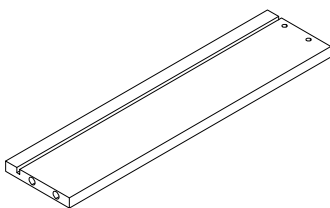

Ⓨ

DRAWER RIGHT SIDE
Qty:1

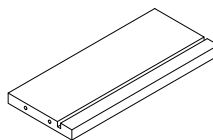

Ⓩ

SMALL DRAWER BACK
Qty:2

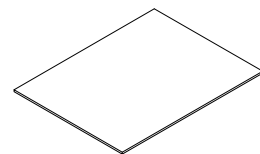

ⒶⒶ

SMALL DRAWER BOTTOM
Qty:2

Board Identification

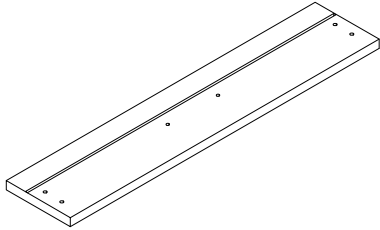

BB

BIG DRAWER FRONT
Qty:1

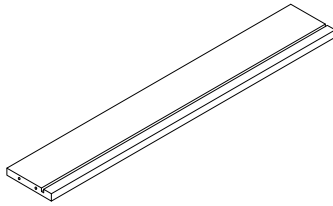

CC

BIG DRAWER BACK
Qty:1

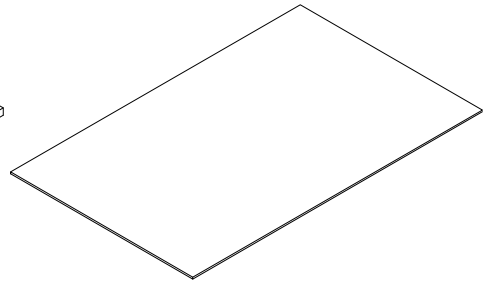

DD

BIG DRAWER BOTTOM
Qty:1

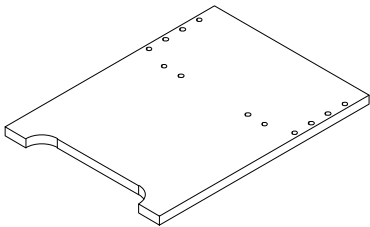

EE

STOOL SIDE PANEL
Qty:2

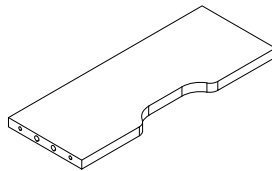

FF

STOOL FRONT APRON
Qty:1

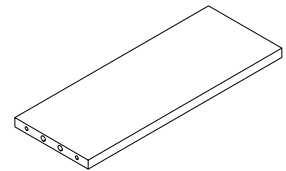

GG

STOOL BACK APRON
Qty:1

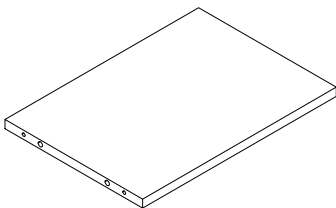

HH

STOOL BOTTOM BOARD
Qty:1

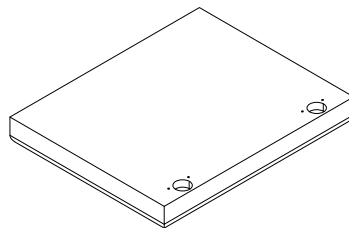

II

SPONGE CUSHION
Qty:1

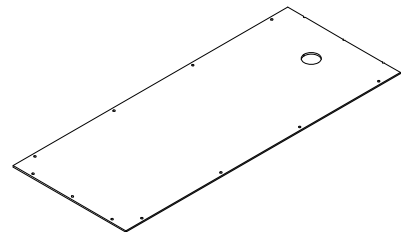

JJ

BACK PANEL
Qty:1

Board Identification

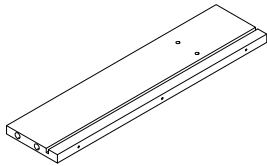

ⓀⓀ

DRAWER LEFT SIDE
Qty:2

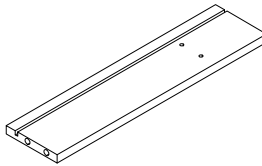

ⓁⓁ

DRAWER RIGHT SIDE
Qty:2

Board Identification

Not actual size

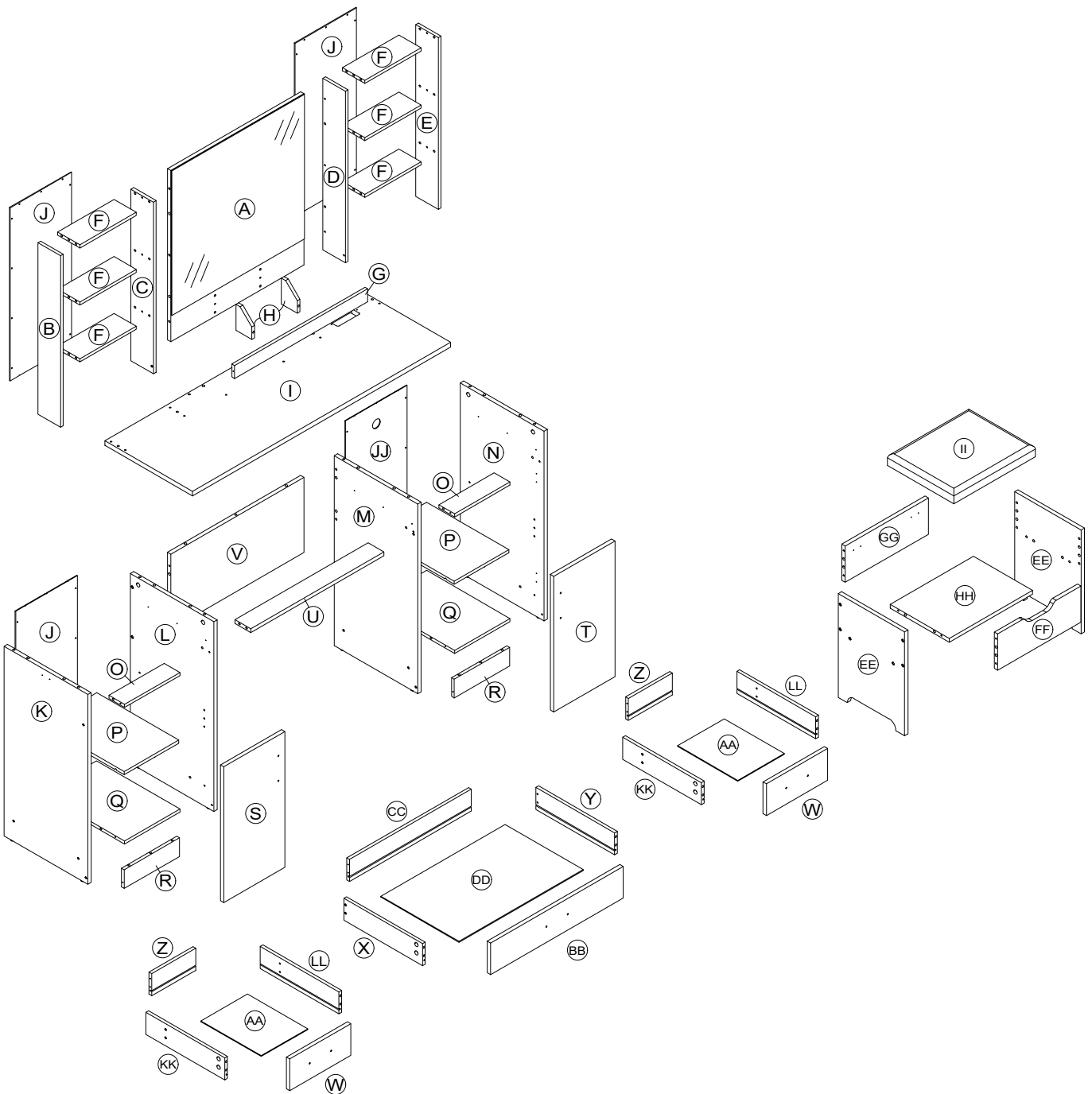

Part List

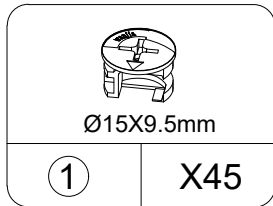

CAM LOCK
spare:3

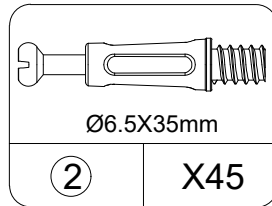

CAM BOLT
spare:3

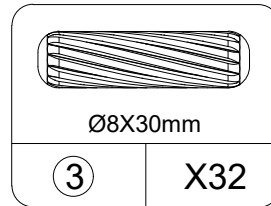

WOODEN DOWEL
spare:3

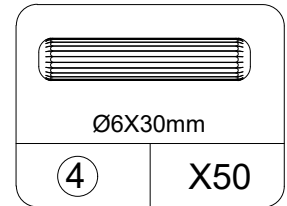

WOODEN DOWEL
spare:3

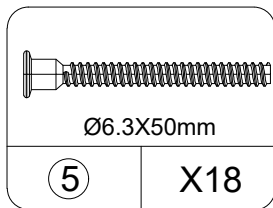

SCREW
spare:2

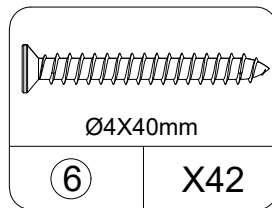

SCREW
spare:3

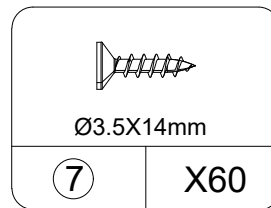

SCREW
spare:3

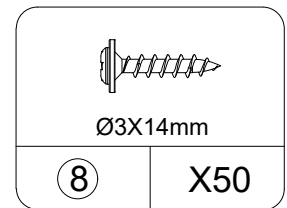

SCREW
spare:3

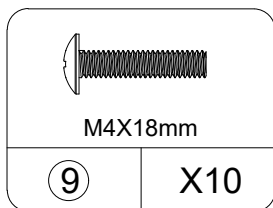

SCREW
spare:1

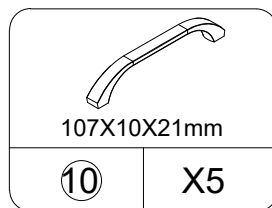

HANDLE

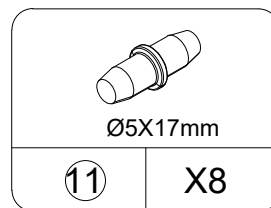

SHELF SUPPORT
spare:1

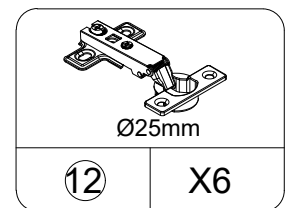

HINGE

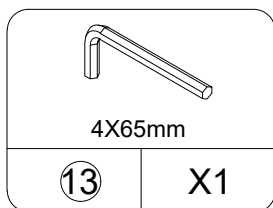

HEXAGON WRENCH

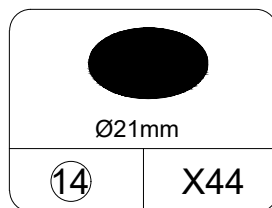

PERFECT STICKER
spare:3

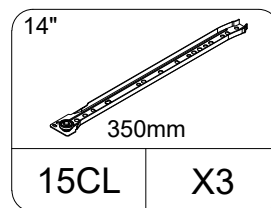

LEFT CABINET MEMBER

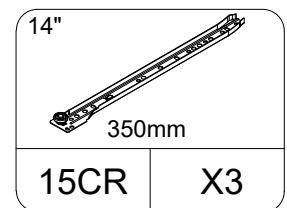

RIGHT CABINET MEMBER

Part List

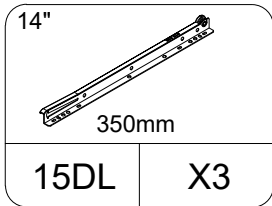

LEFT DRAWER RUNNER

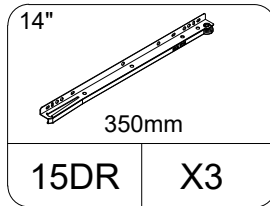

RIGHT DRAWER RUNNER

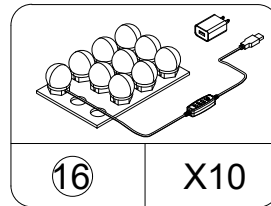

LIGHT BULB

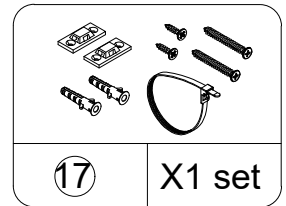

TIPPING RESTRAINT
HARDWARE KIT

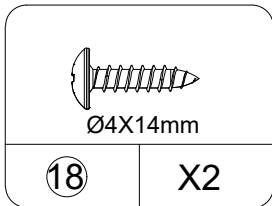

SCREW
spare:1

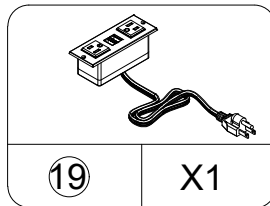

PLUG BOARD

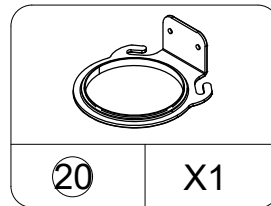

HAIR DRYER RACK

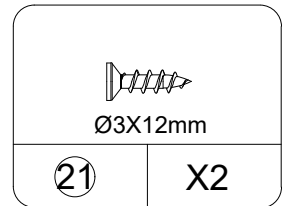

SCREW
spare:1

Cam Lock Fastening System

Insert the cam bolt into the hole first, then insert the cam lock and lock it.

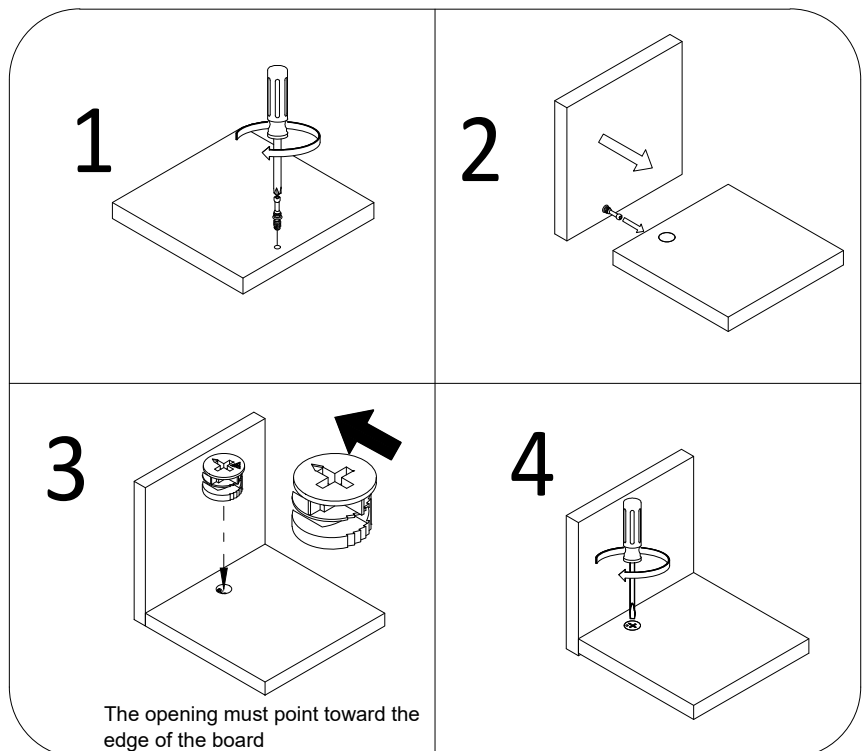

STEP 1

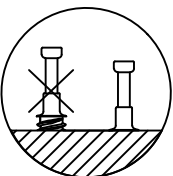
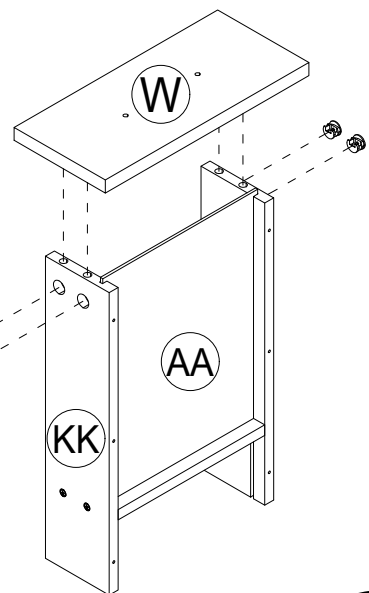
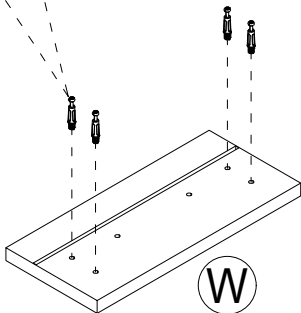
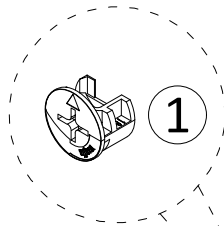
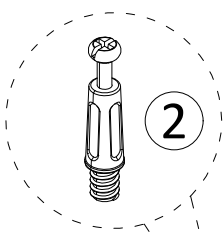
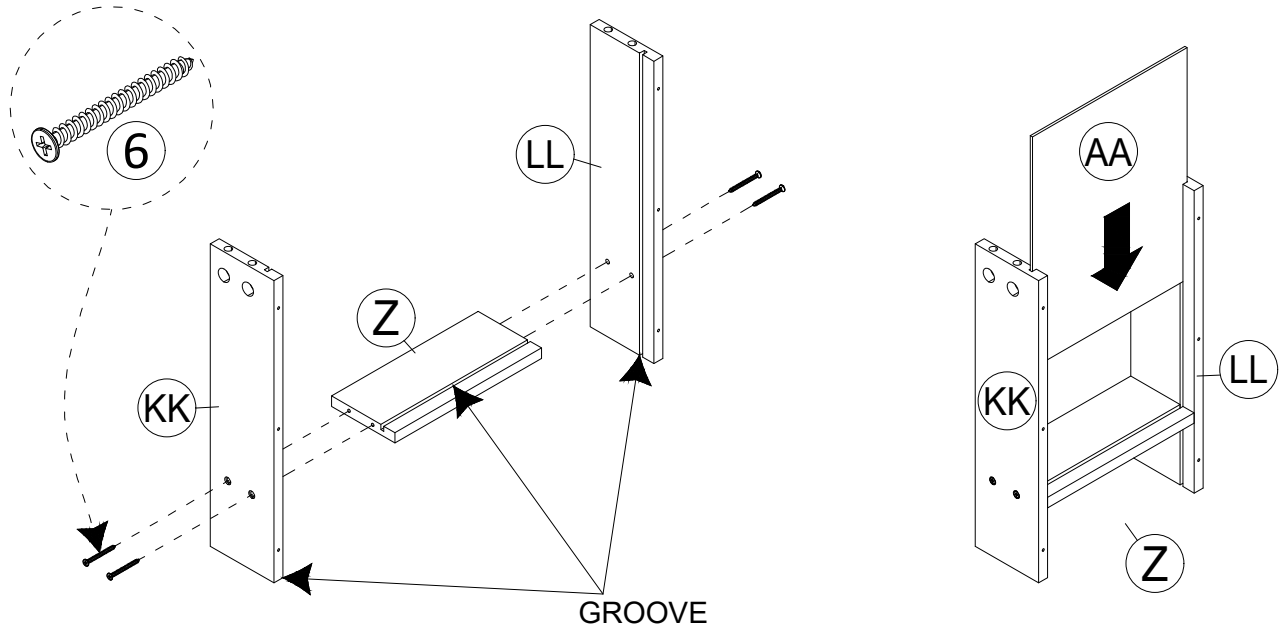
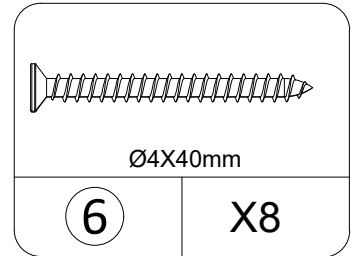
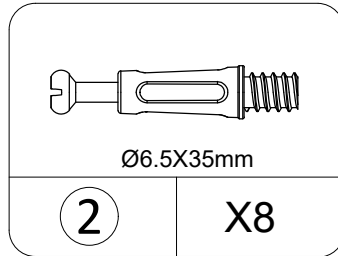
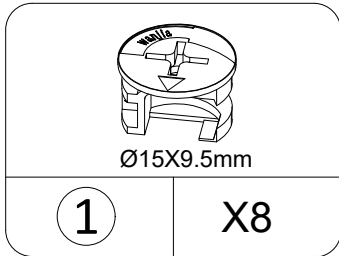
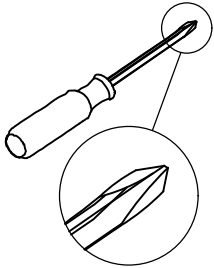

X 2

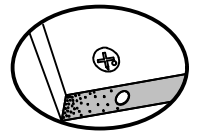

Proper orientation of CAM LOCK

STEP 2

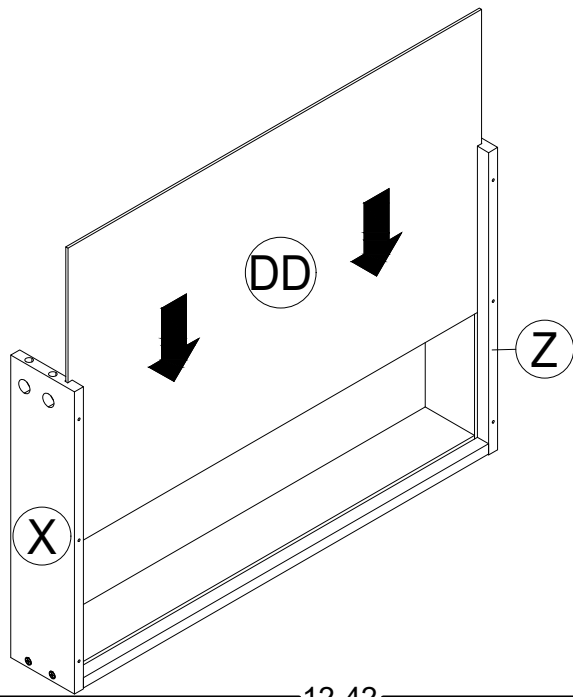
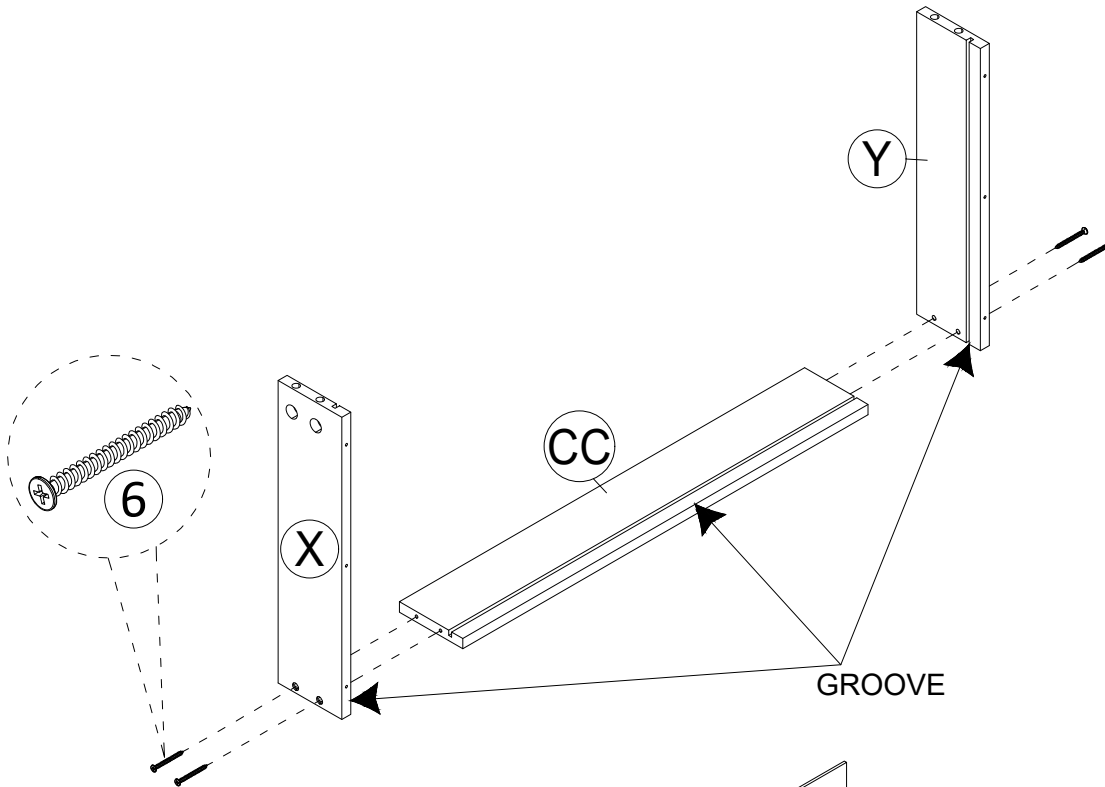
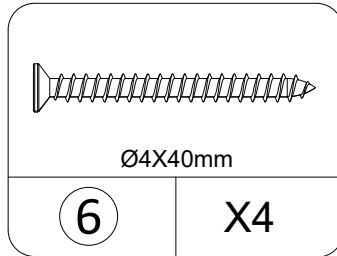
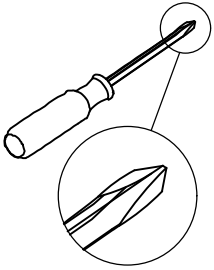

STEP 3

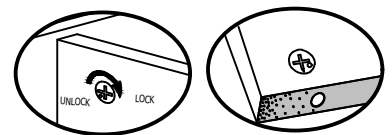
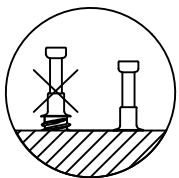
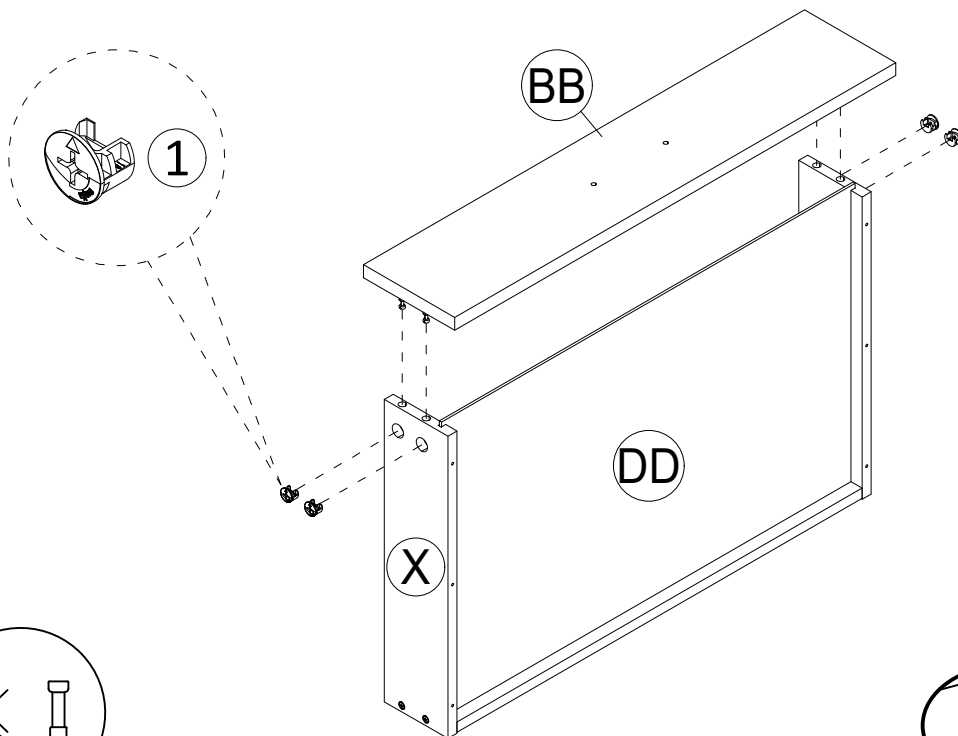
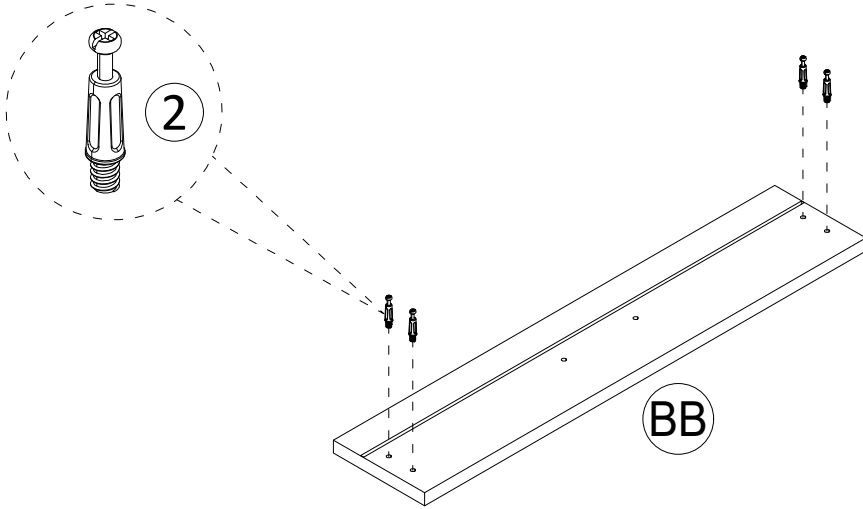
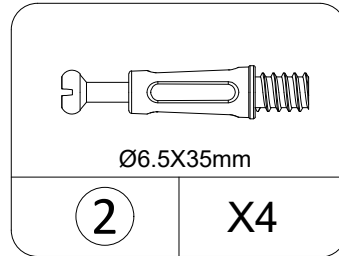
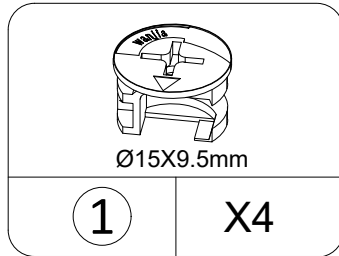
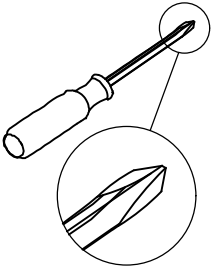

Proper orientation of CAM LOCK

STEP 4

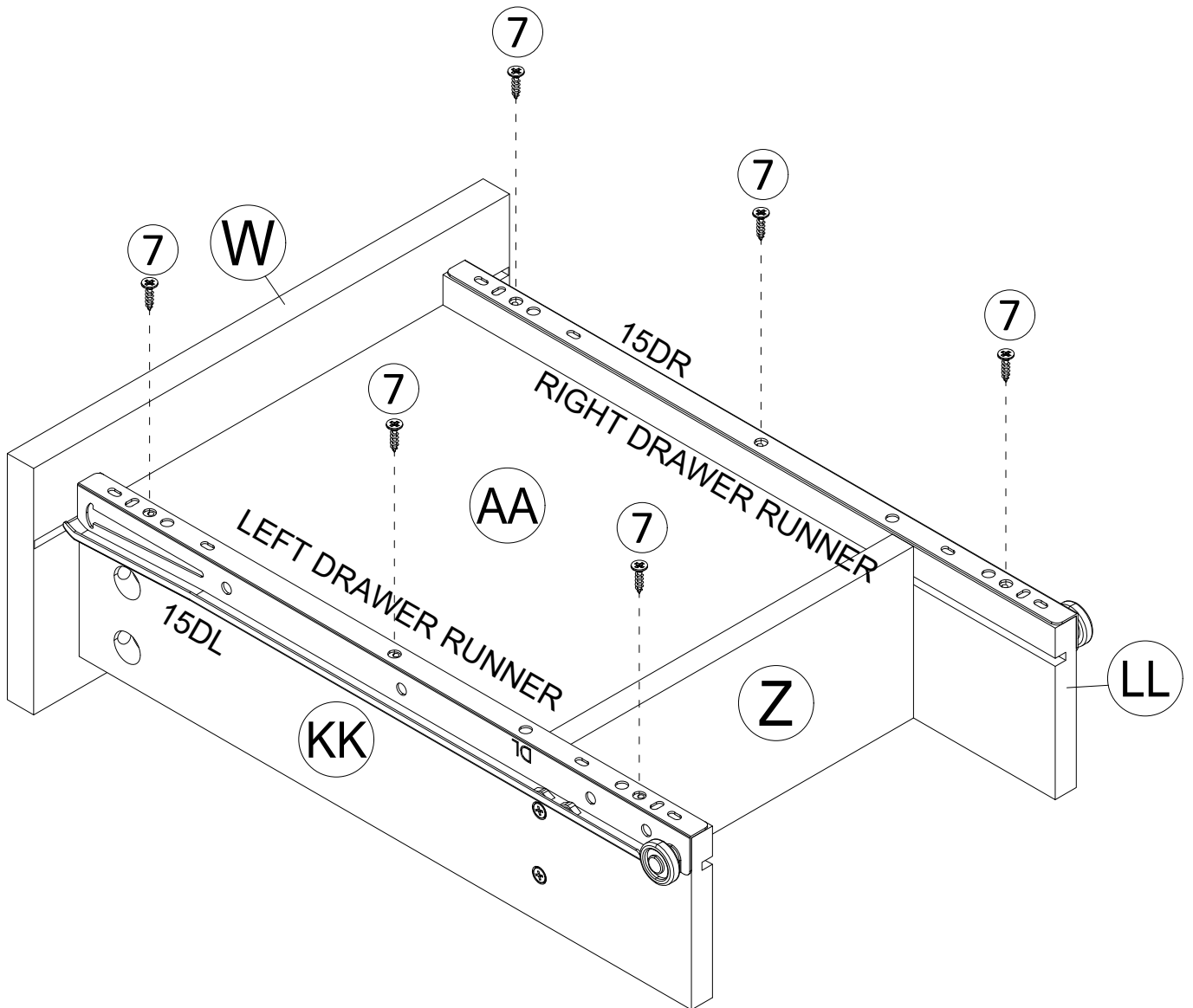
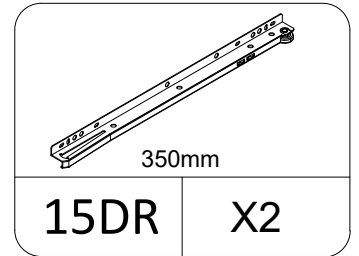
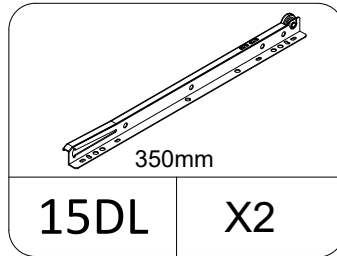
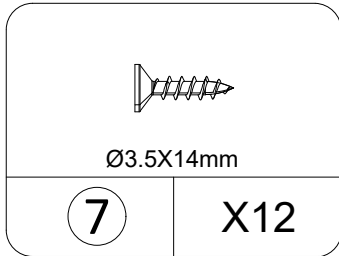
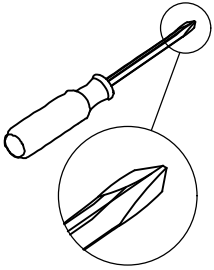

X 2

STEP5

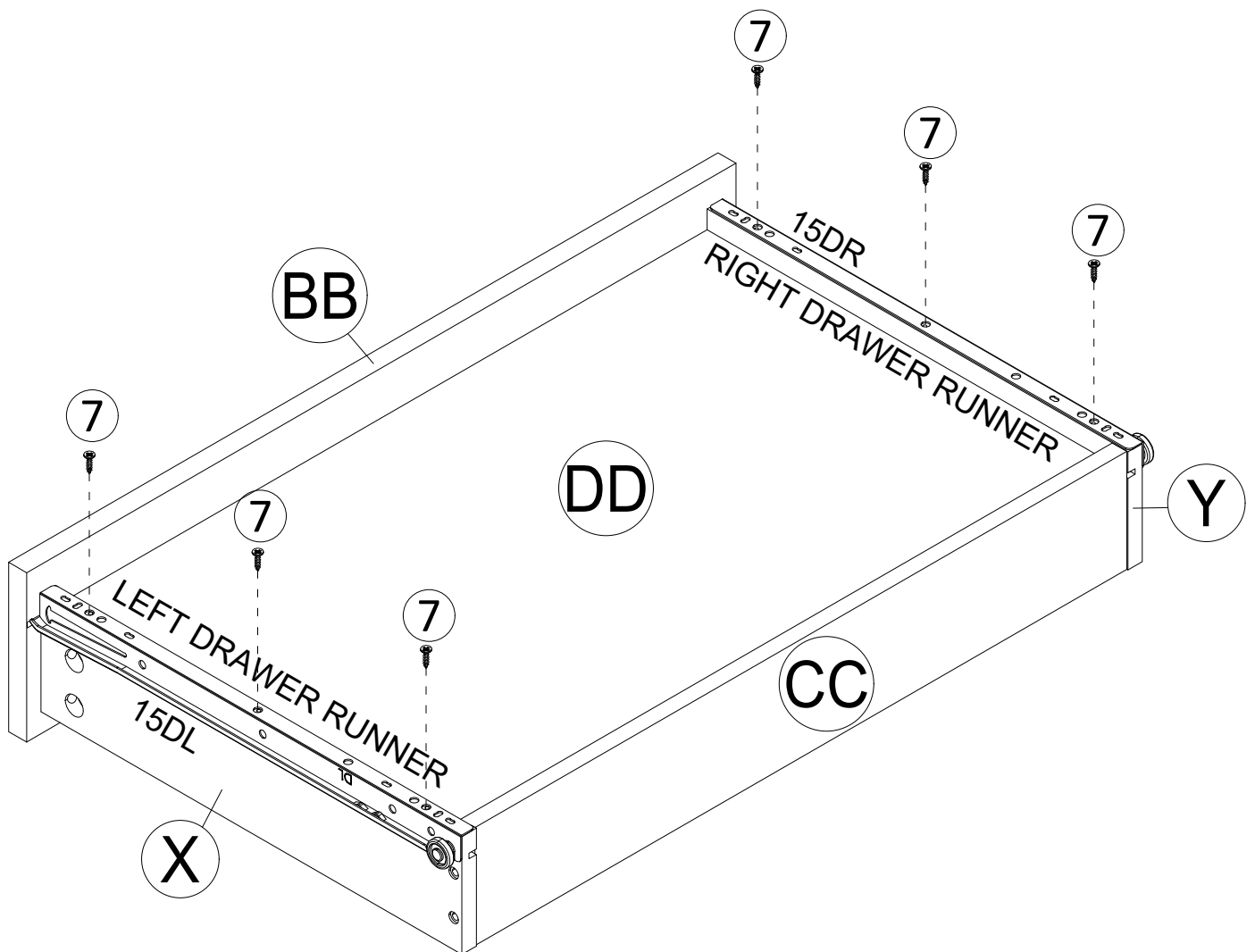
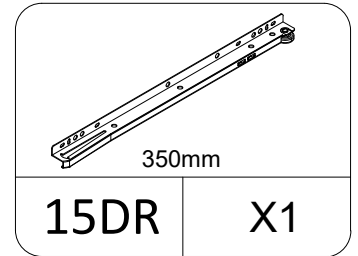
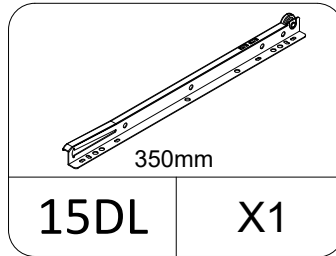
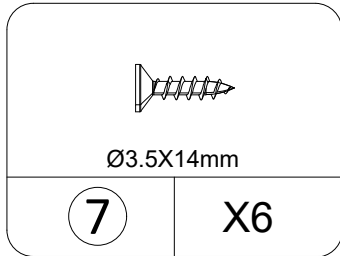
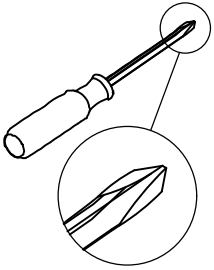

STEP 6

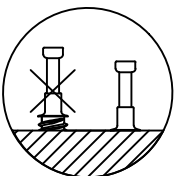
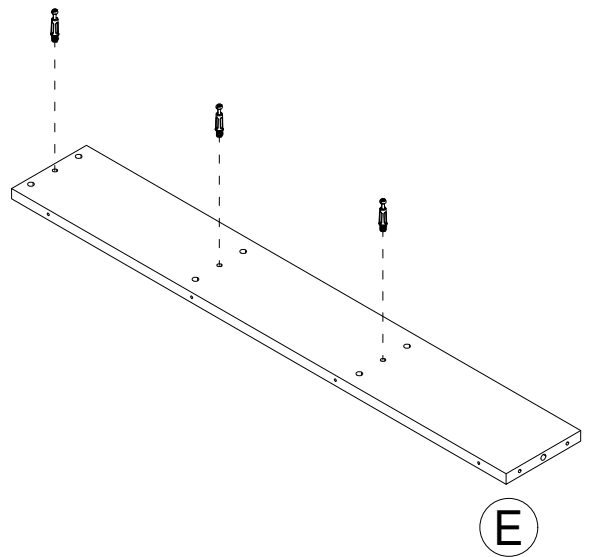
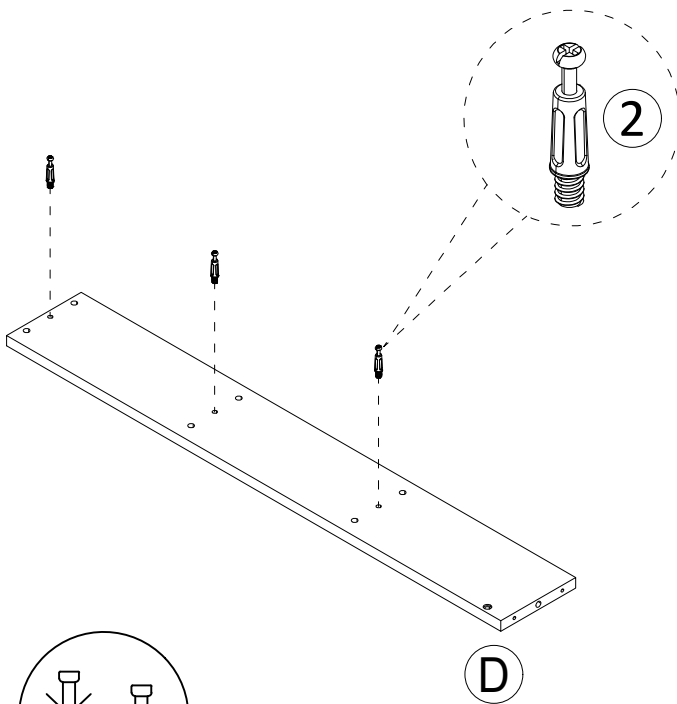
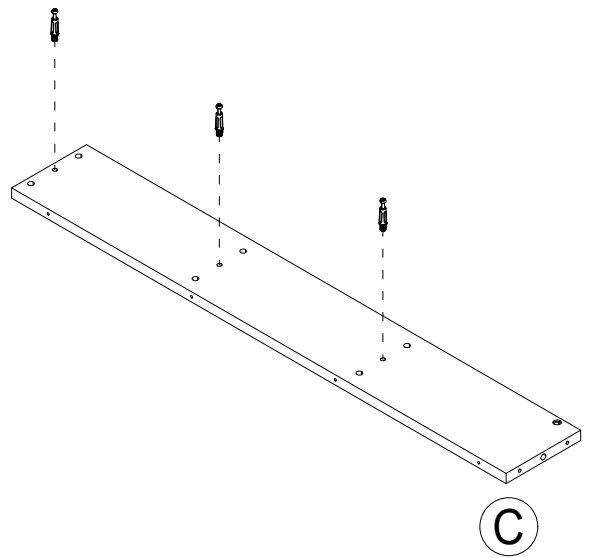
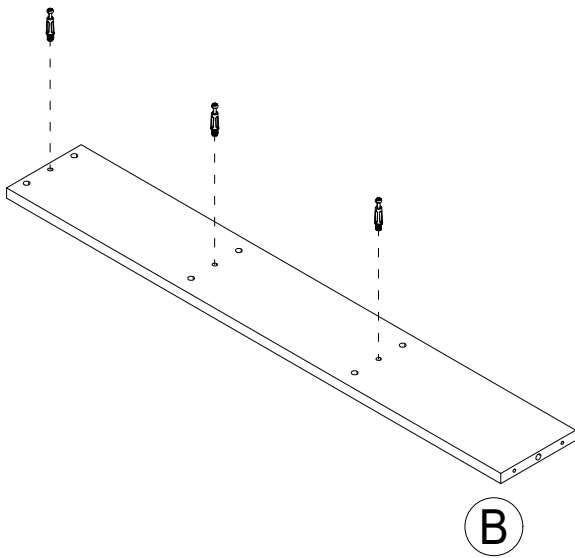
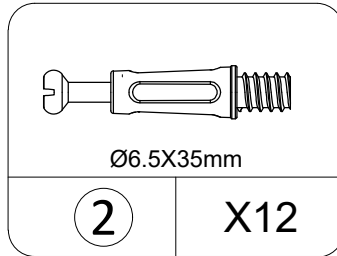
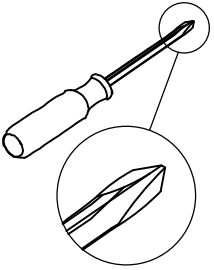

STEP 7

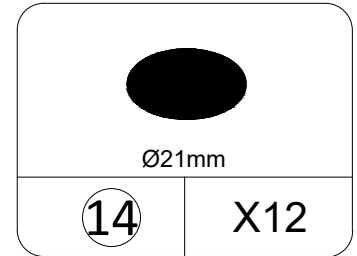
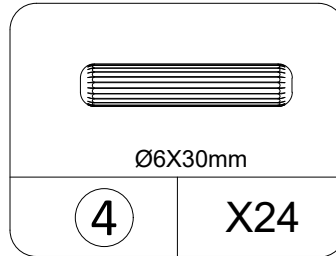
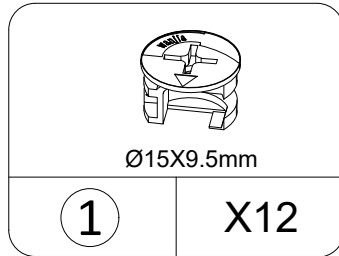
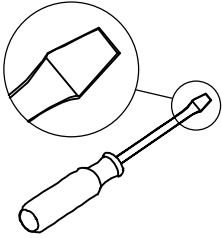

EDGE BANDING

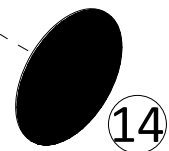
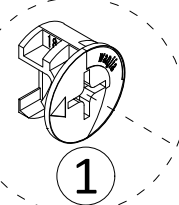
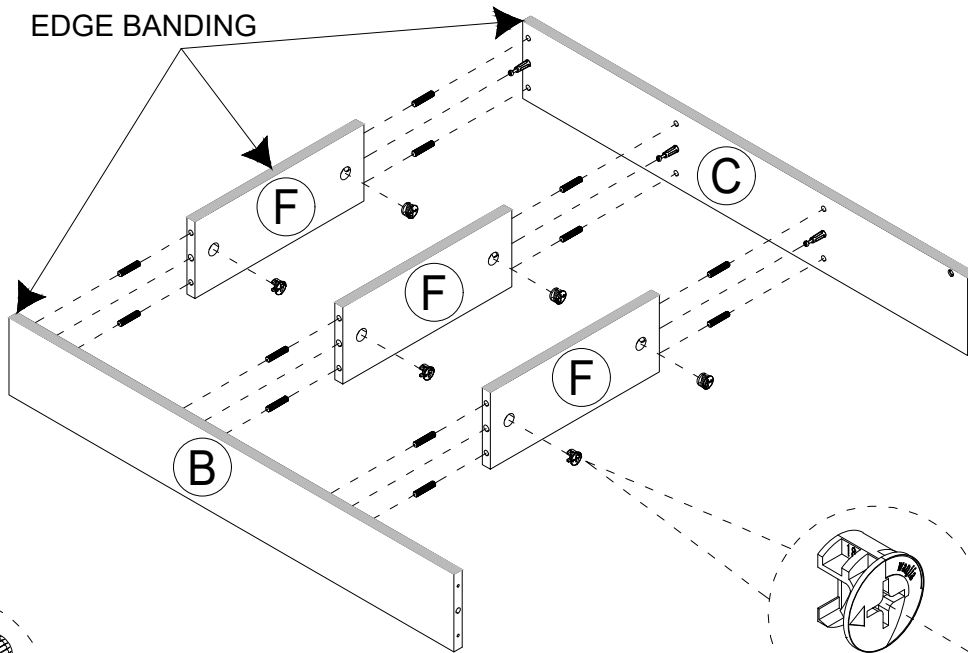

EDGE BANDING

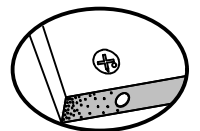
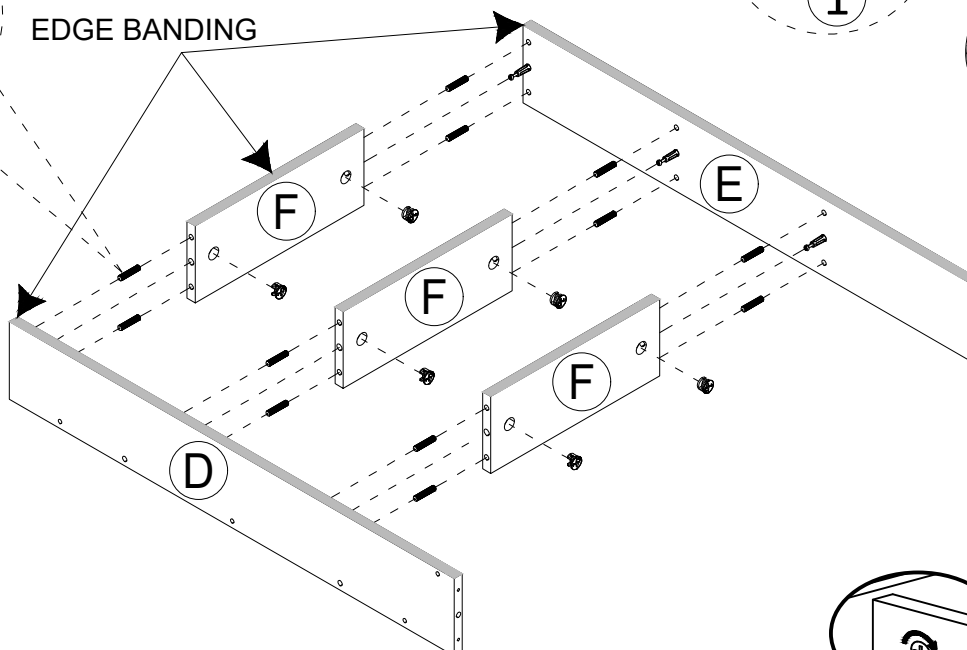
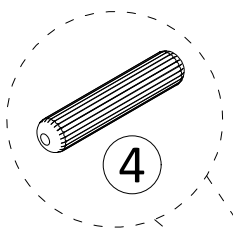

Proper orientation of CAM LOCK

STEP 8

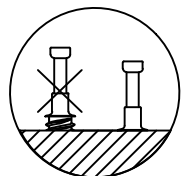
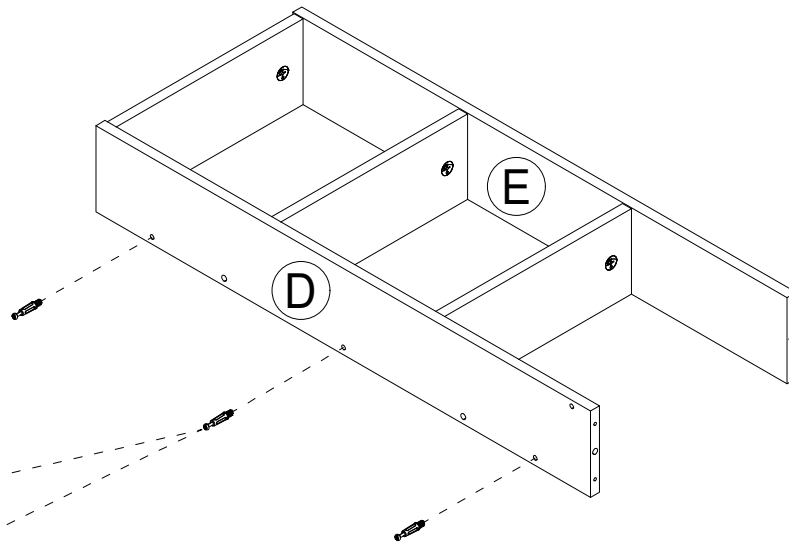
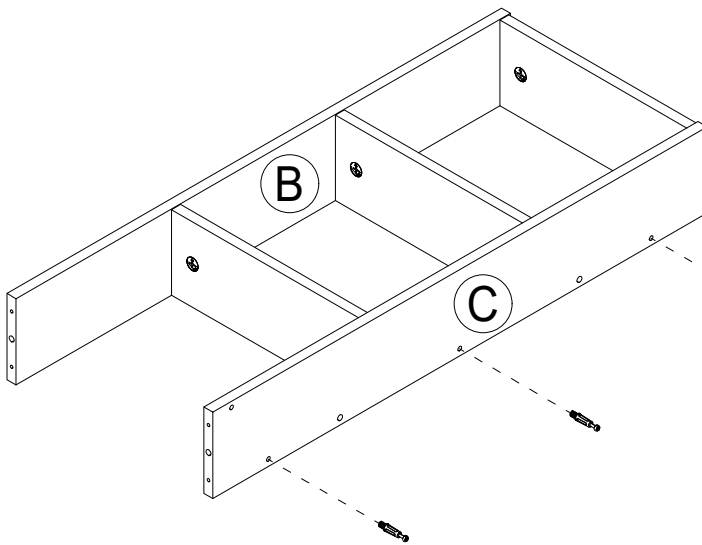
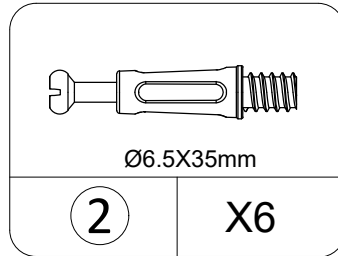
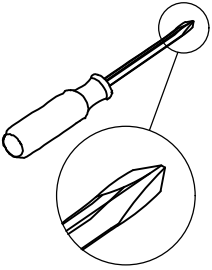

STEP 9



Ø15X9.5mm

1 X2

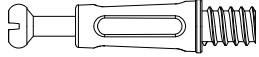

Ø6.5X35mm

2 X2



Ø6X30mm

4 X4

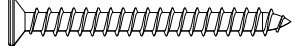

Ø4X40mm

6 X2



Ø21mm

14 X2

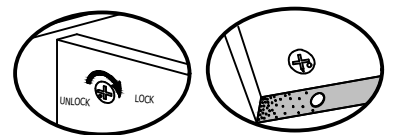
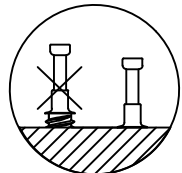
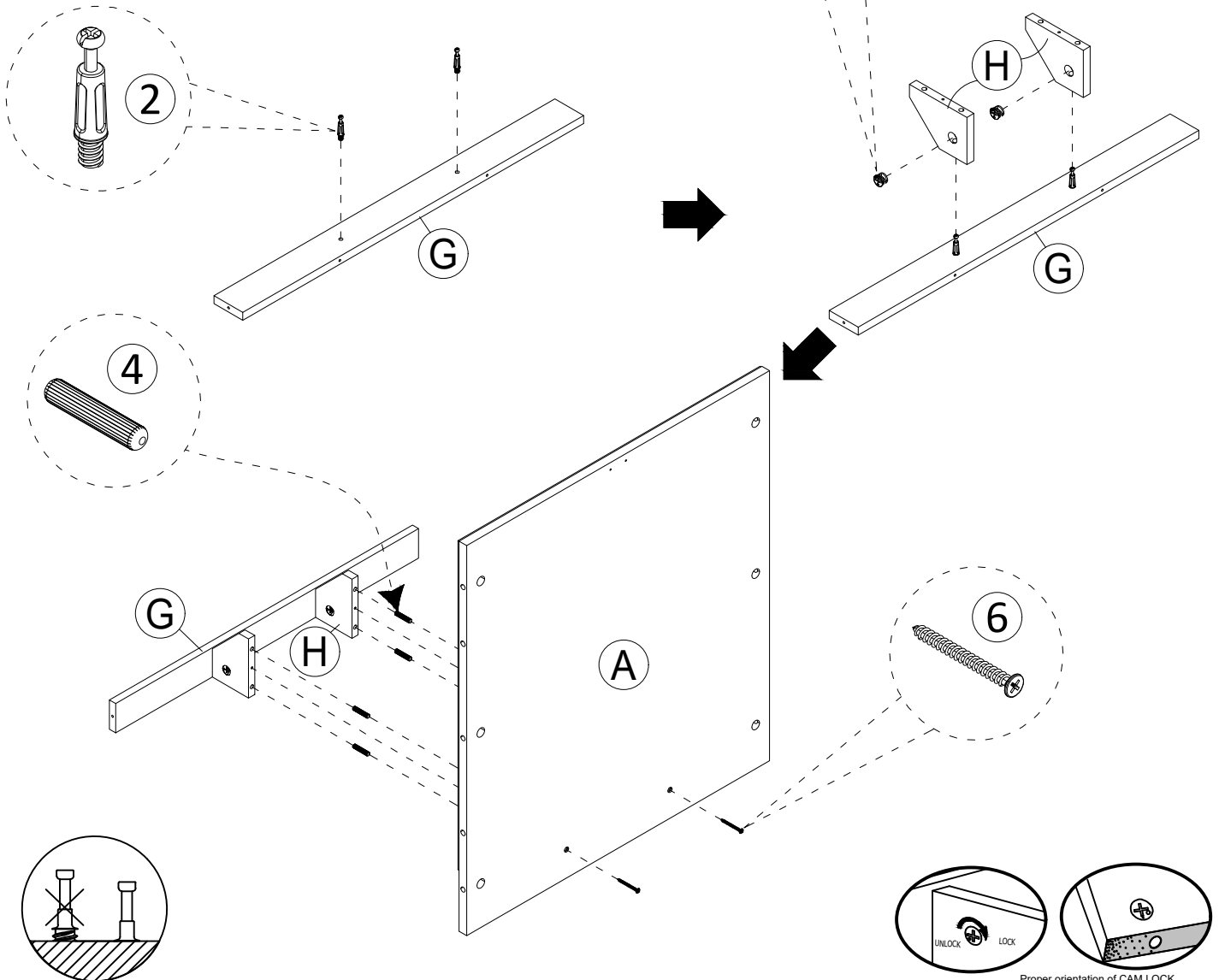
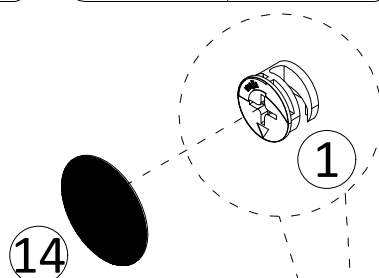
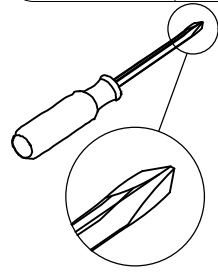

Proper orientation of CAM LOCK

STEP 11

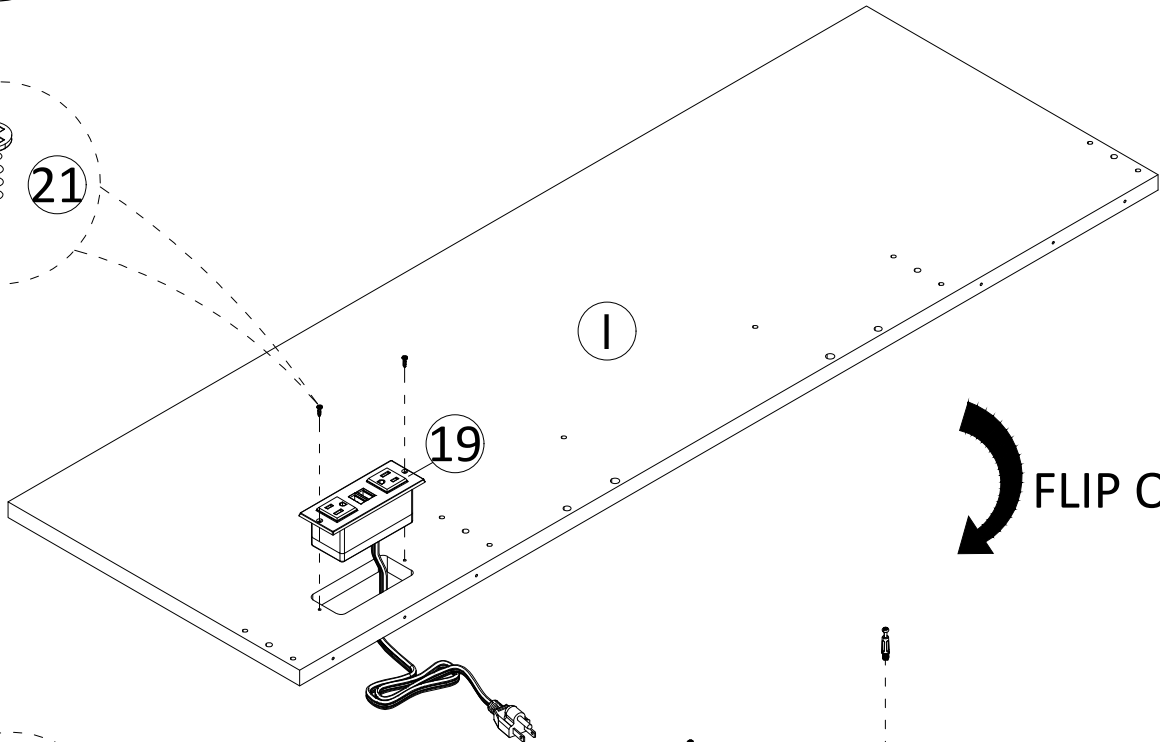
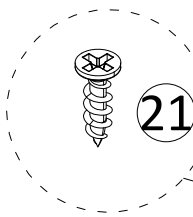
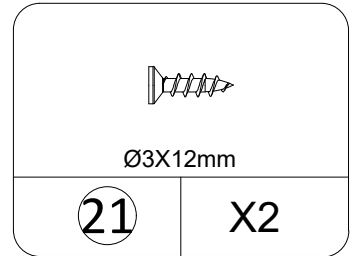
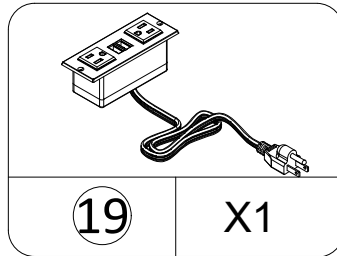
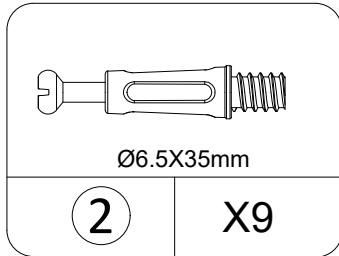
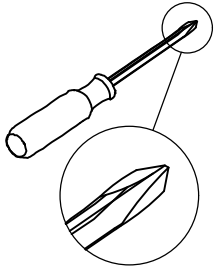

FLIP OVER

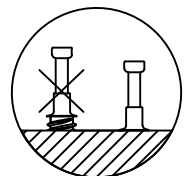
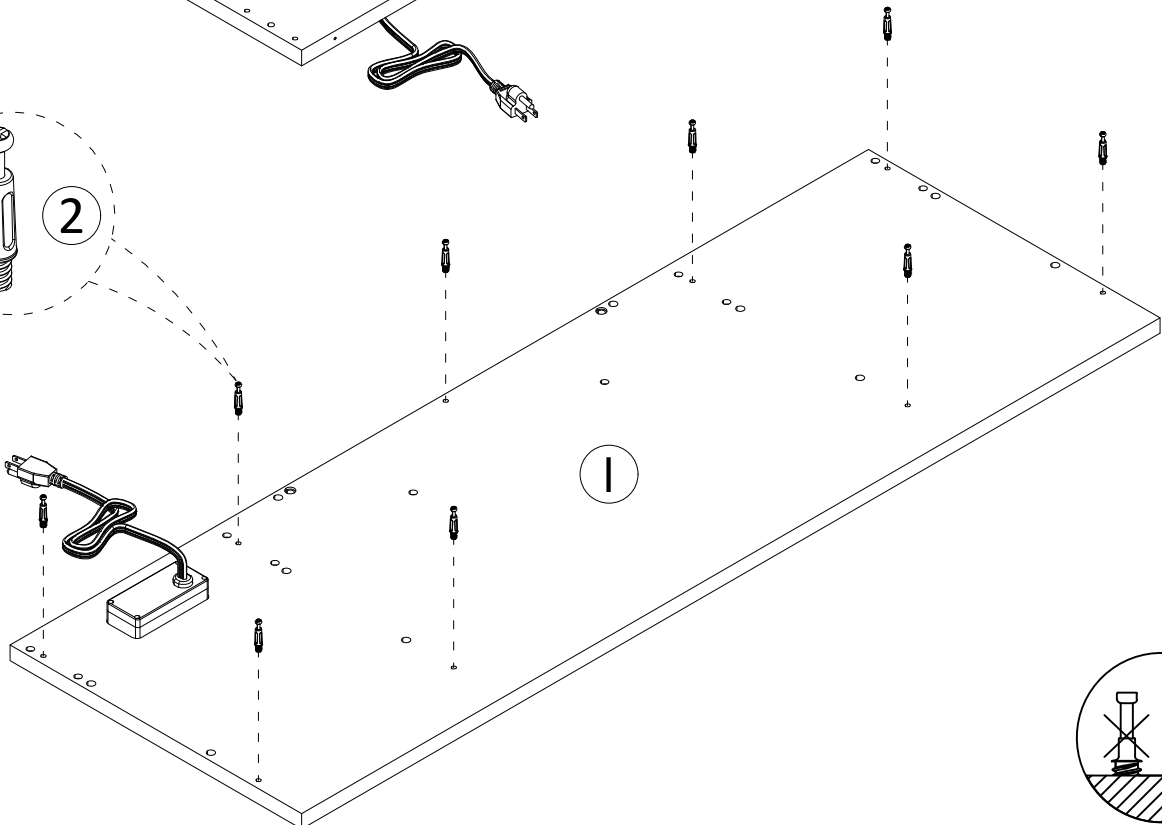
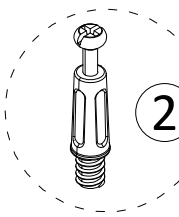

STEP 12

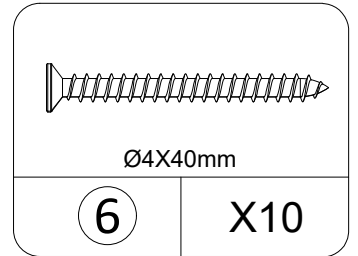
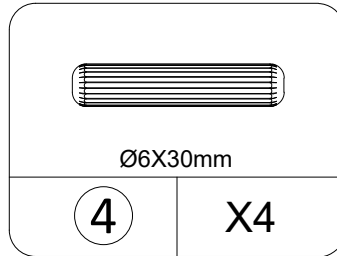
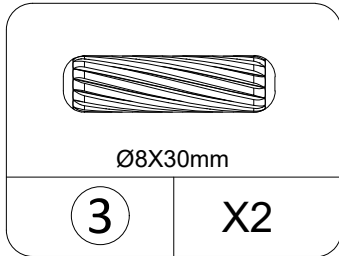
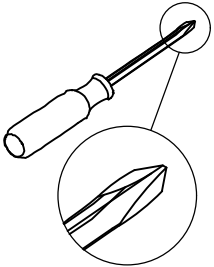

Note: before installing the wood dowel, please ensure that the size of these two wood dowel pins is Ø8*30MM

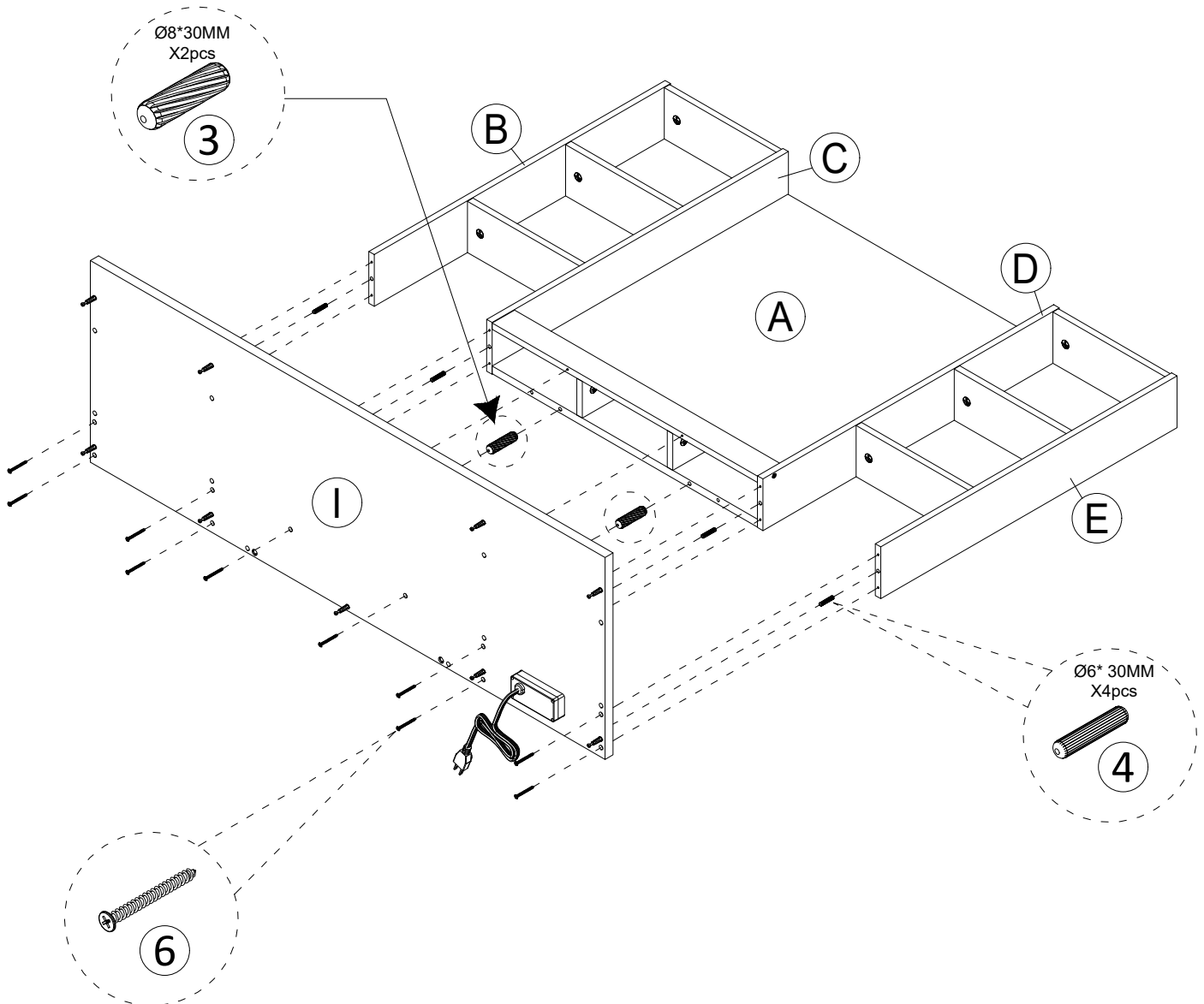

STEP13

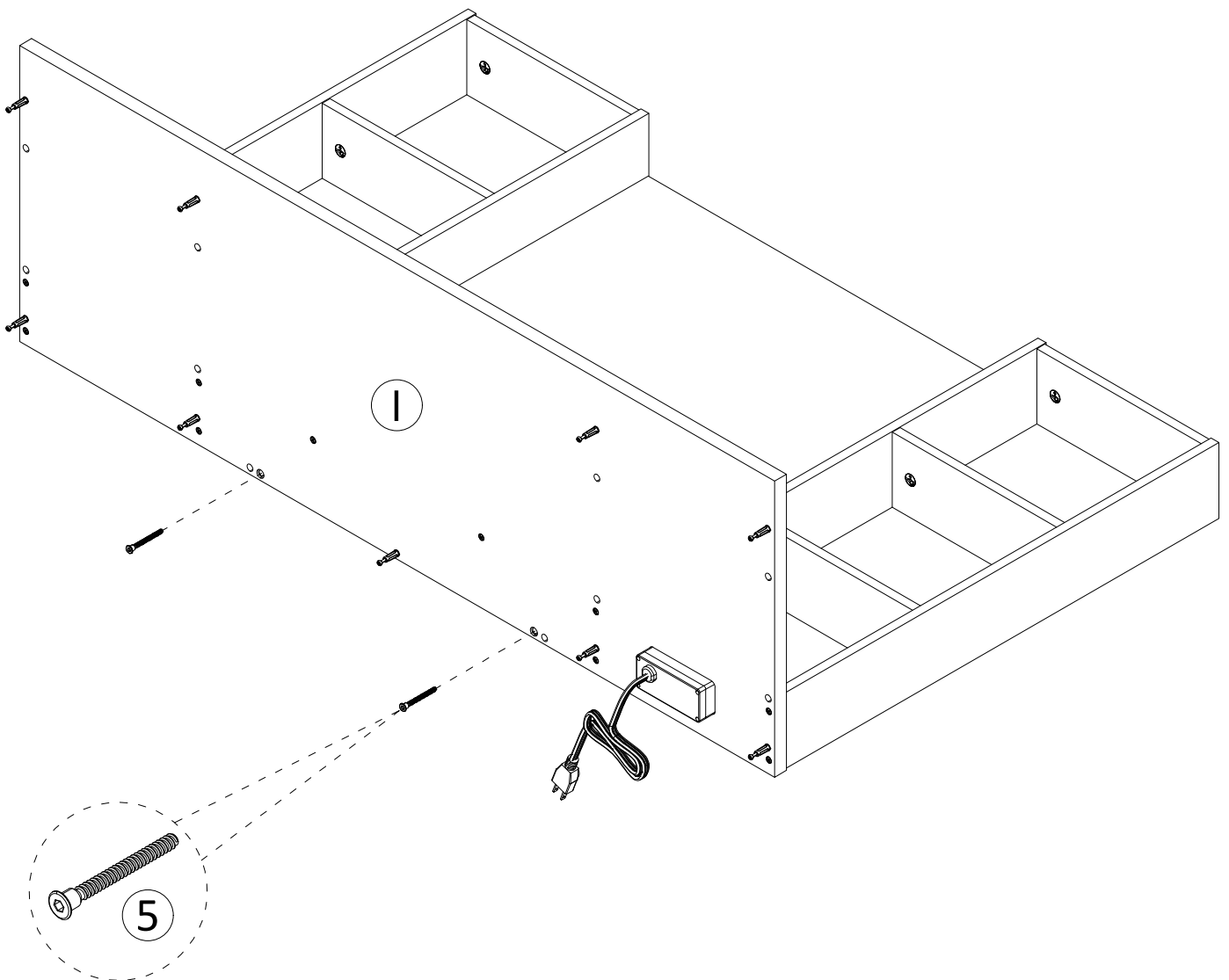
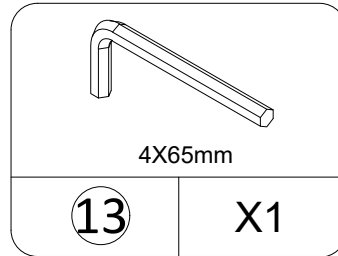
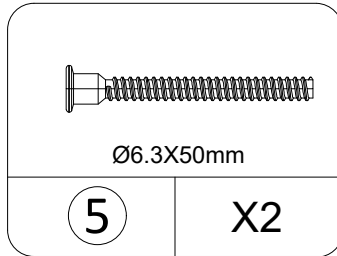
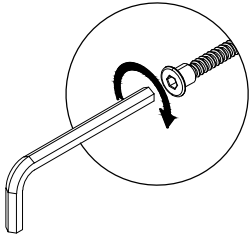

STEP 14

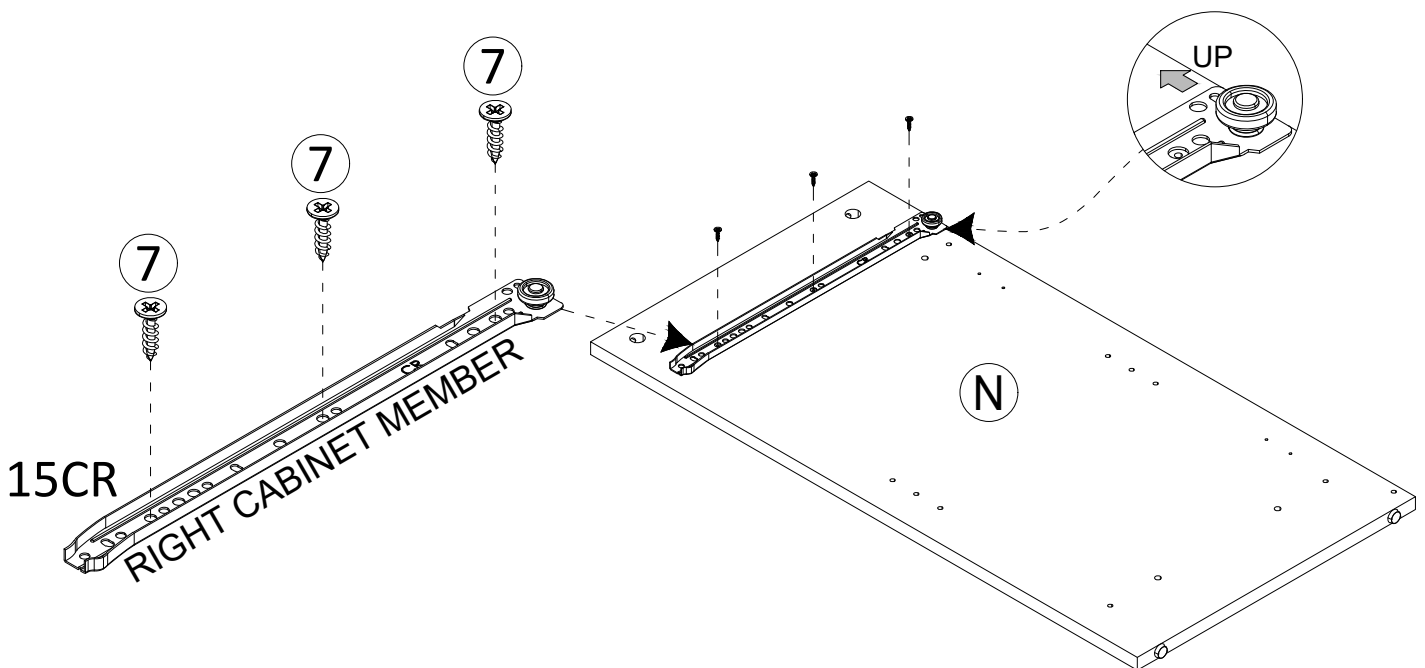
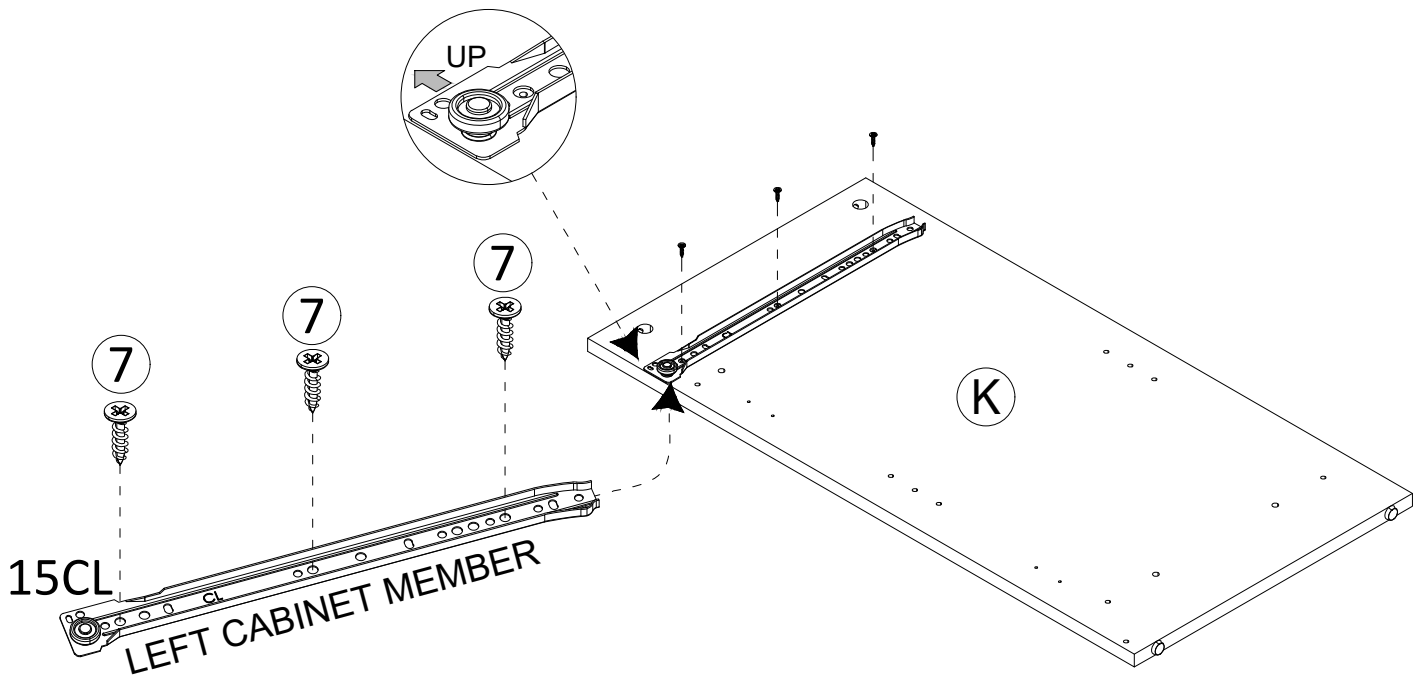
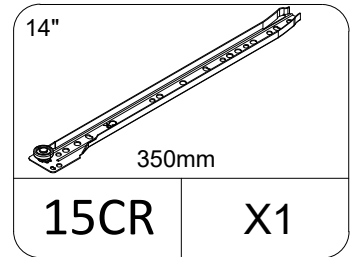
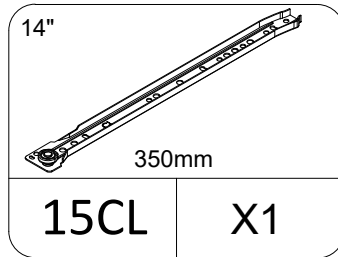
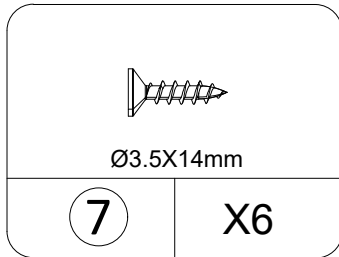
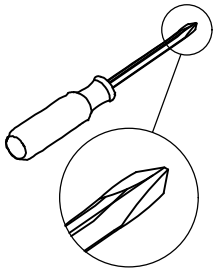

STEP 15



Ø6.5X35mm

2	X1
---	----

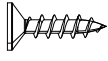

Ø3.5X14mm

7	X6
---	----

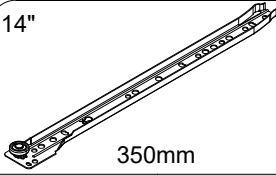

14"
350mm

15CR	X1
------	----

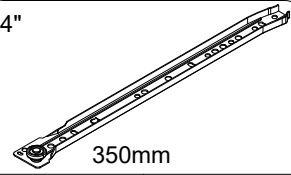

14"
350mm

15CL	X1
------	----

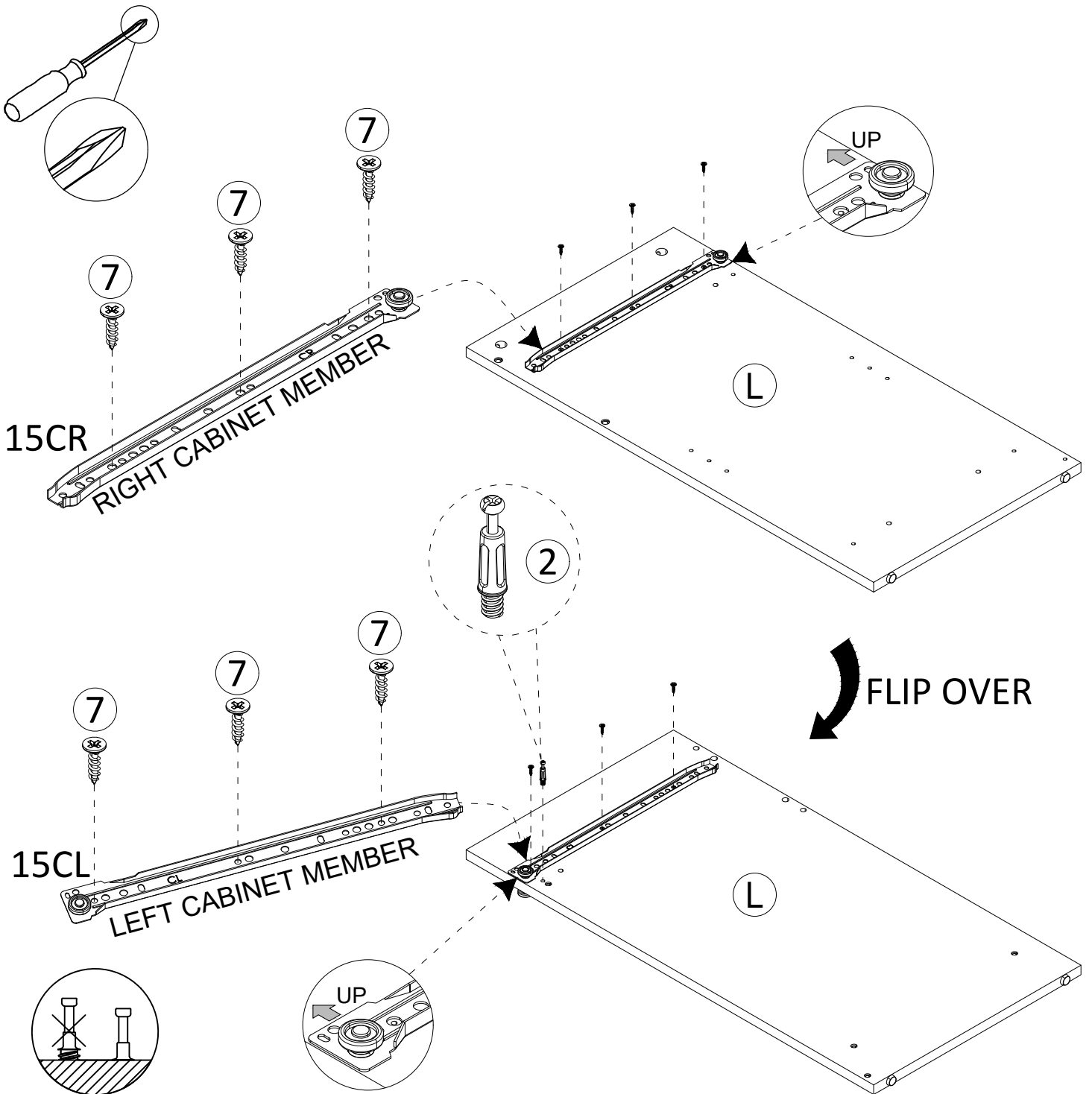

STEP 16

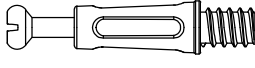

Ø6.5X35mm

2	X1
---	----

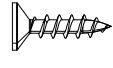

Ø3.5X14mm

7	X6
---	----

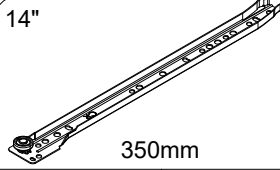

14"
350mm

15CR	X1
------	----

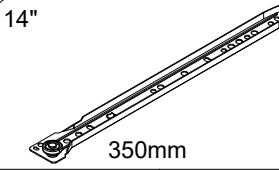

14"
350mm

15CL	X1
------	----

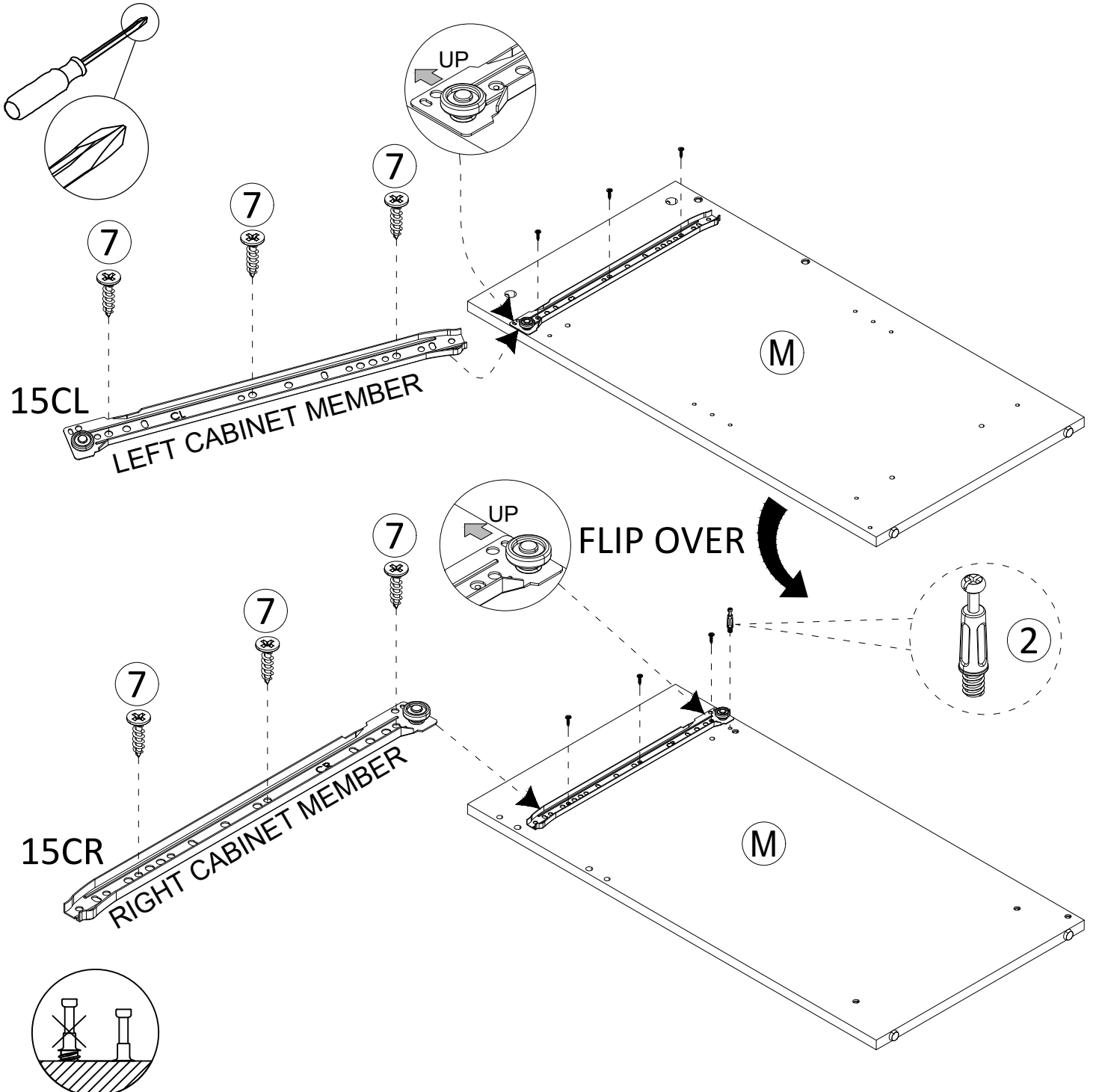

STEP 17

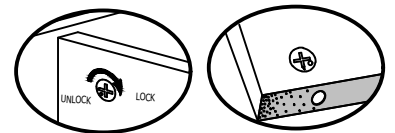
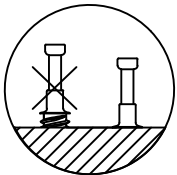
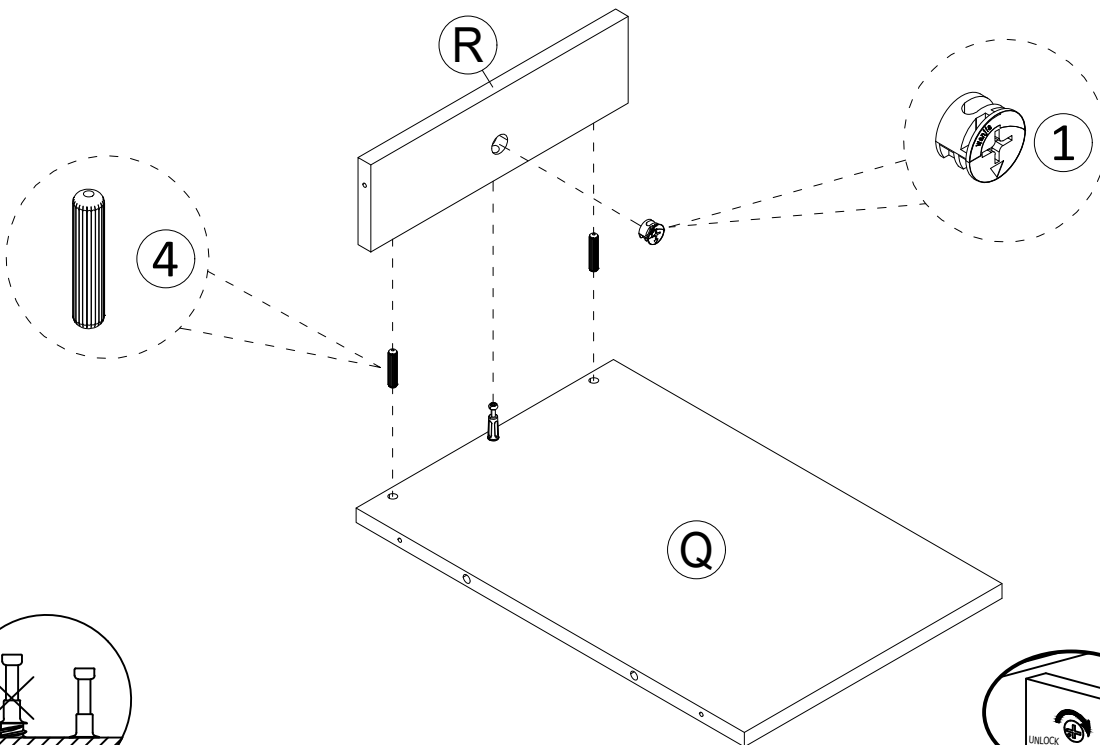
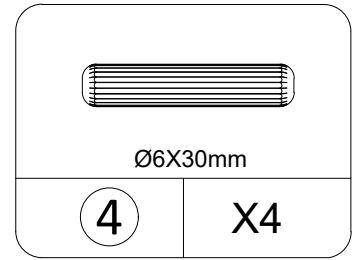
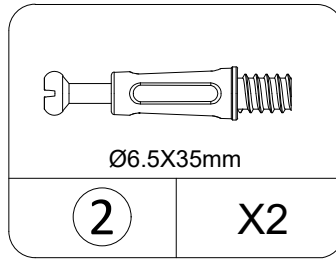
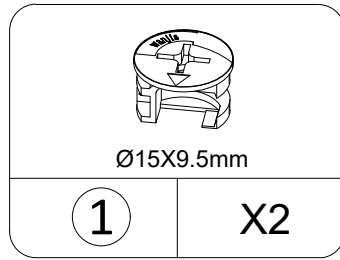
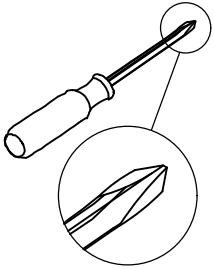

Proper orientation of CAM LOCK

STEP 18

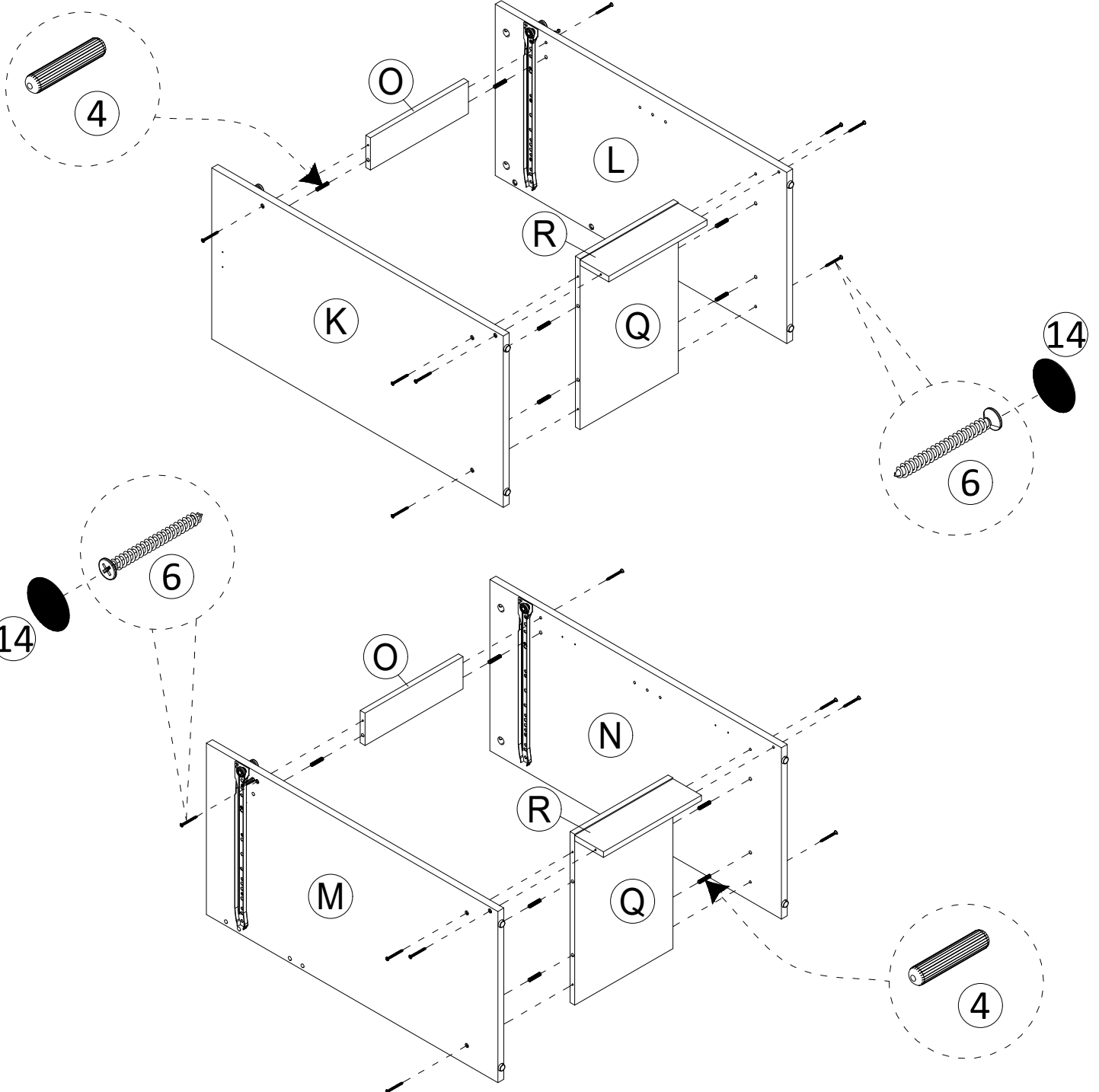
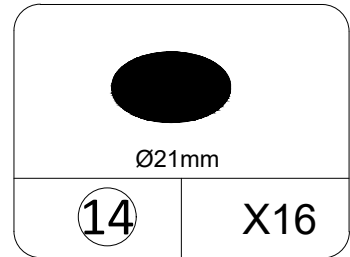
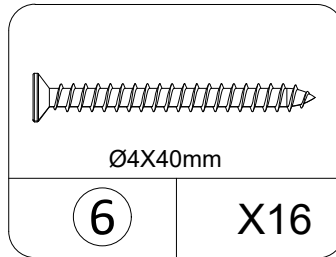
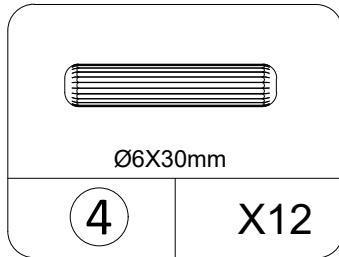
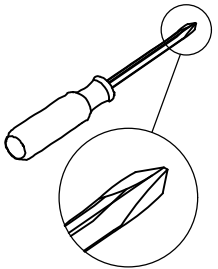

STEP19

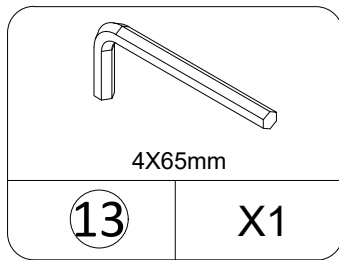
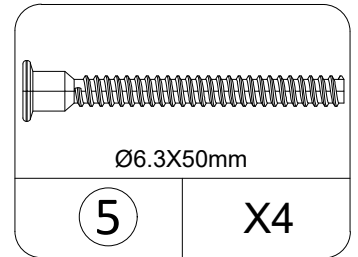
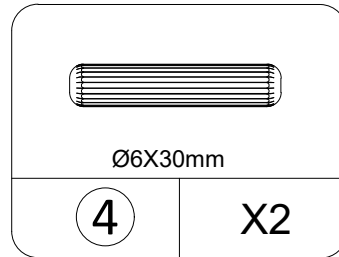
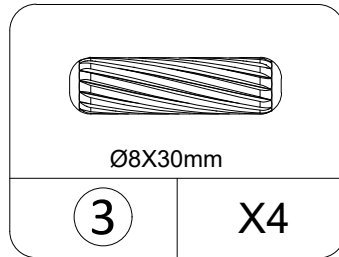
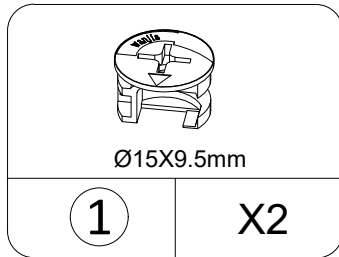

THIS STEP REQUIRES 2 PEOPLE

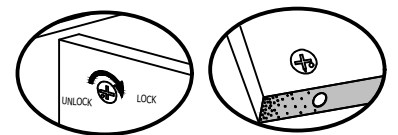
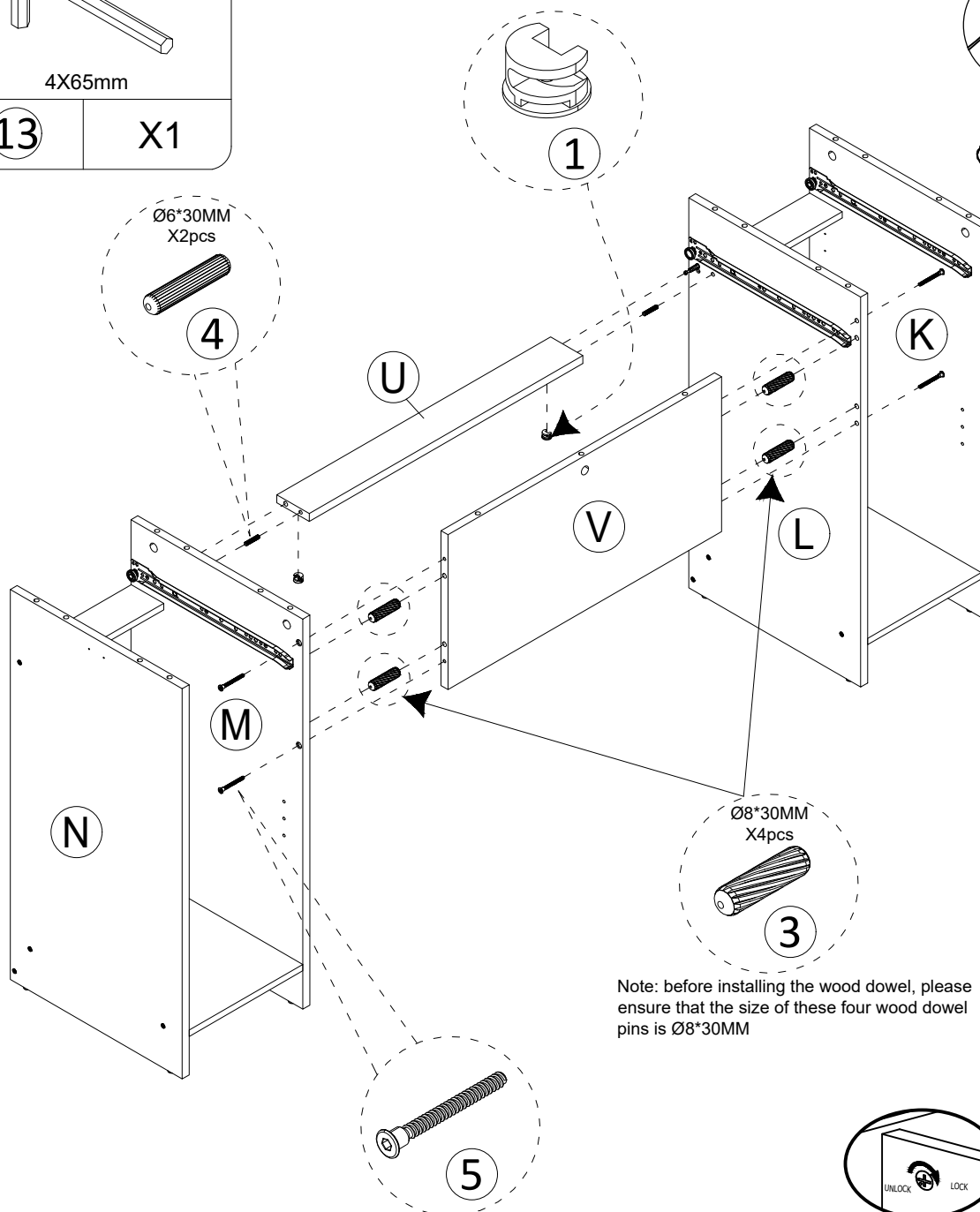

STEP20

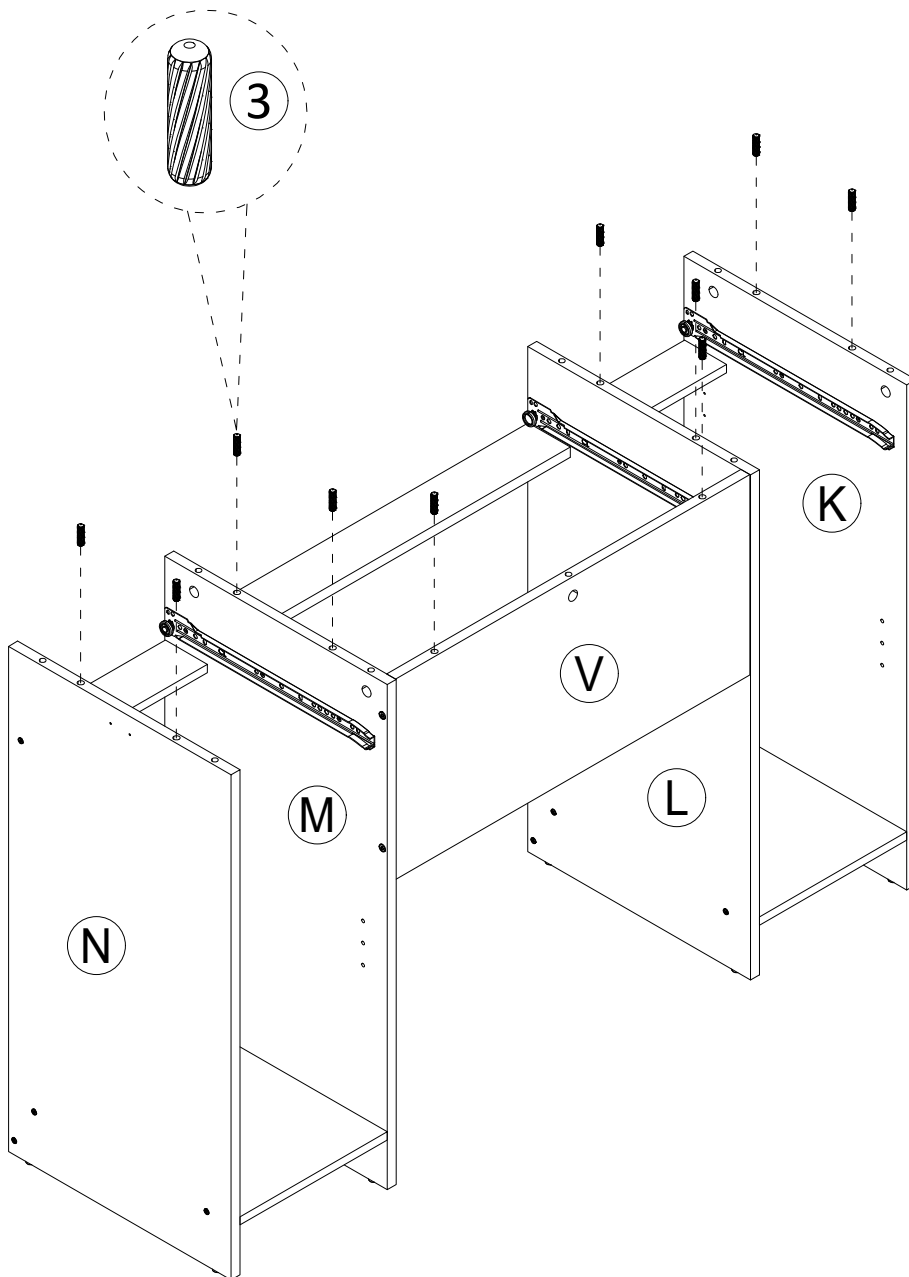
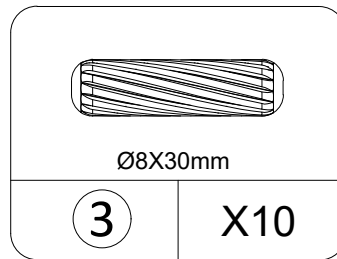

STEP 21

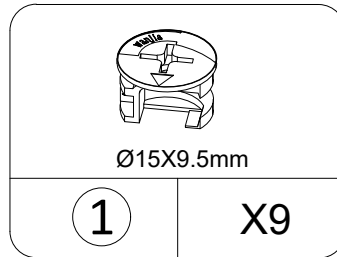
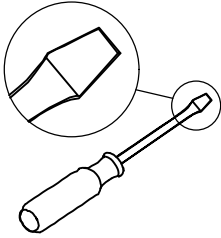

THIS STEP REQUIRES 2 PEOPLE

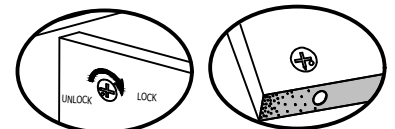
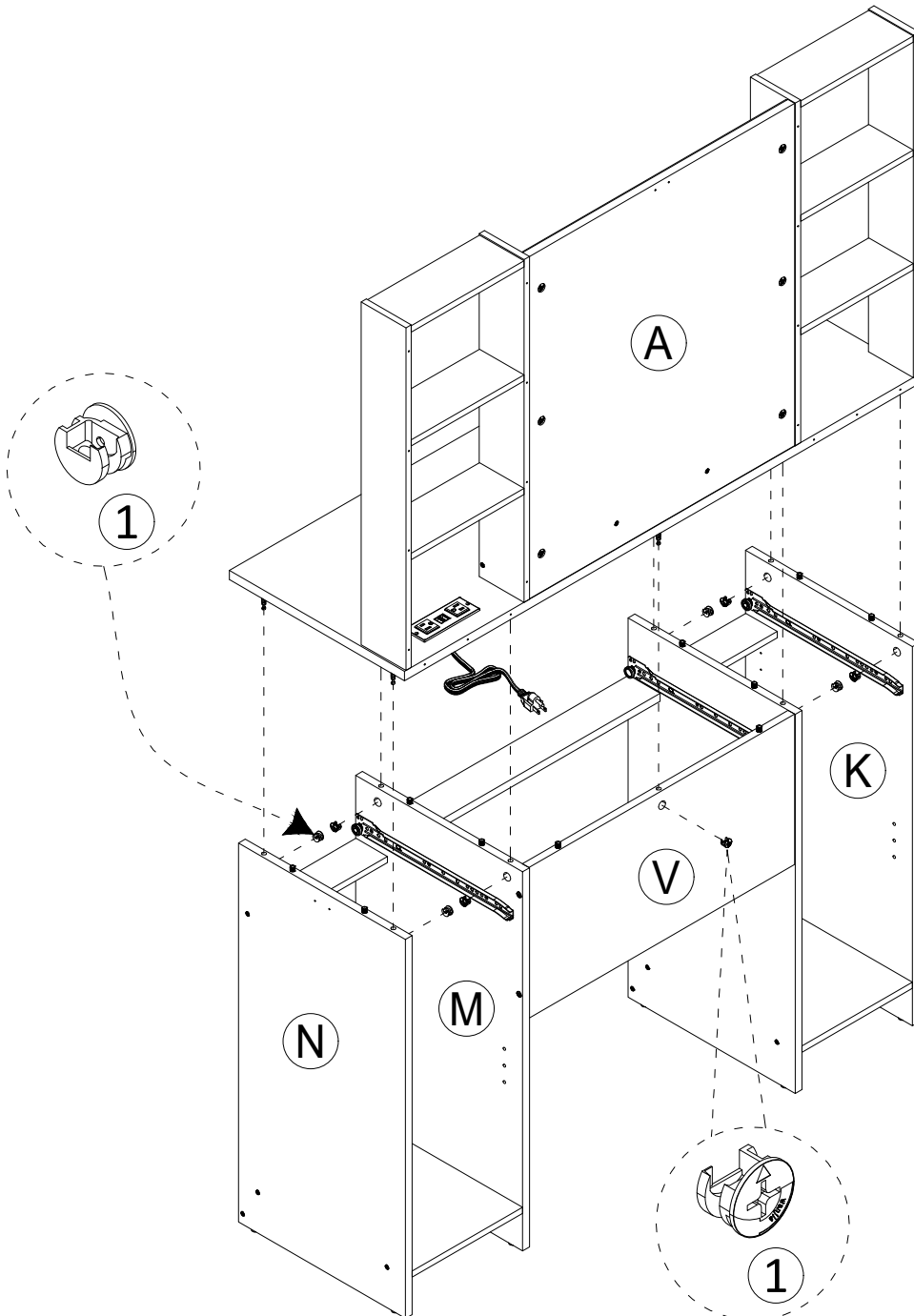

STEP 22

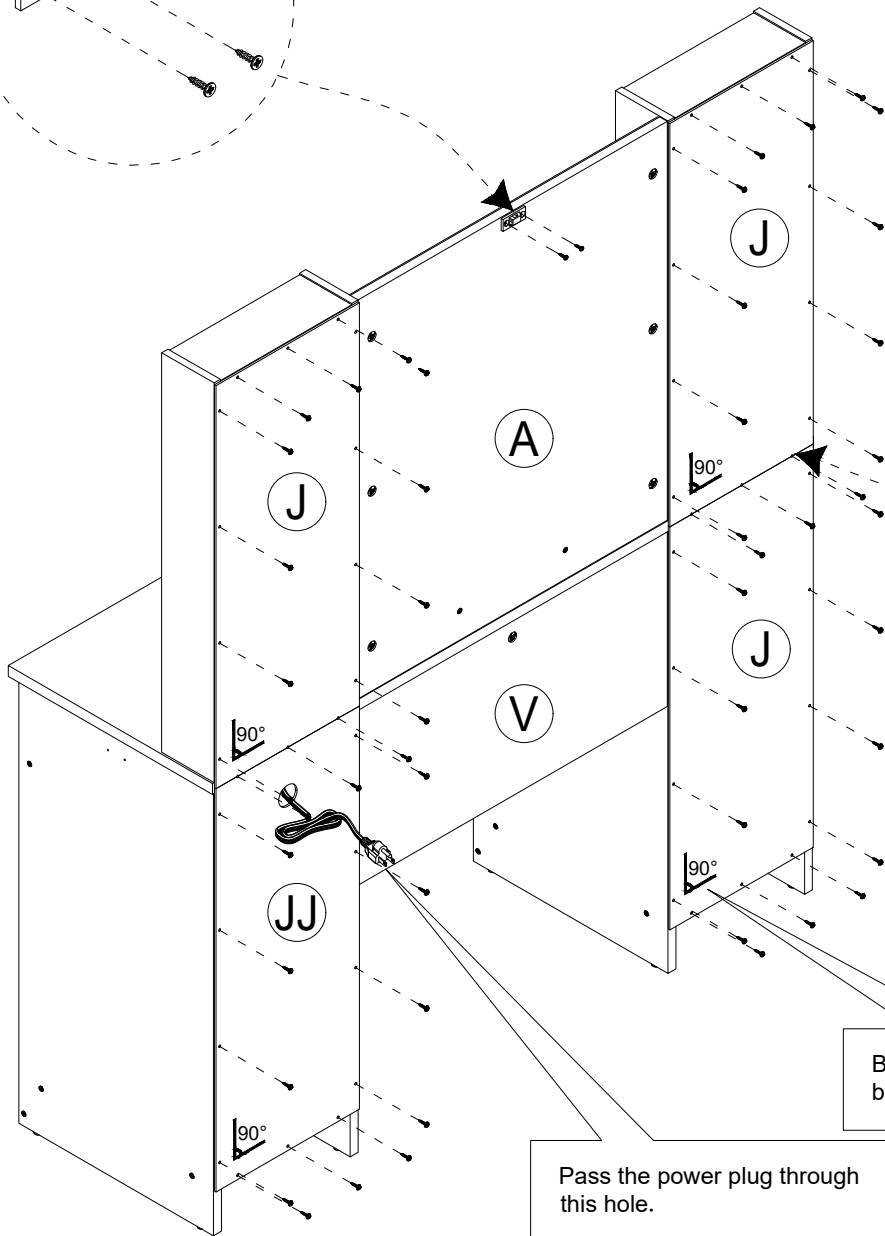
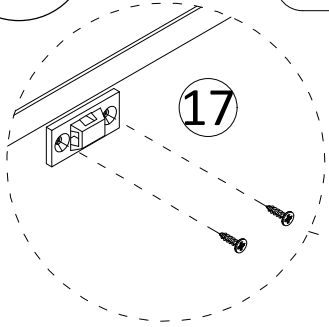
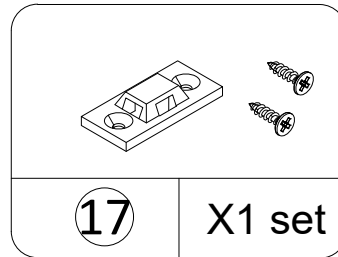
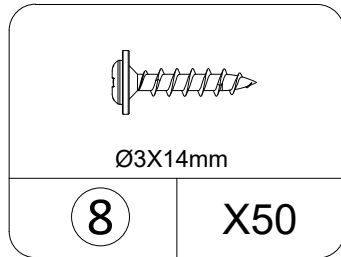
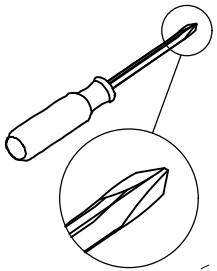

Align the semicircular holes to form a circular hole

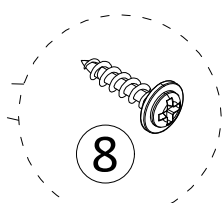
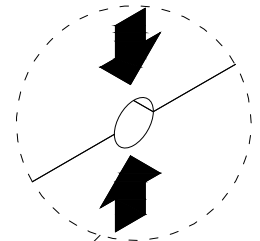

Before attaching the back panel, be sure that the unit is at 90°.

Pass the power plug through this hole.

STEP 23

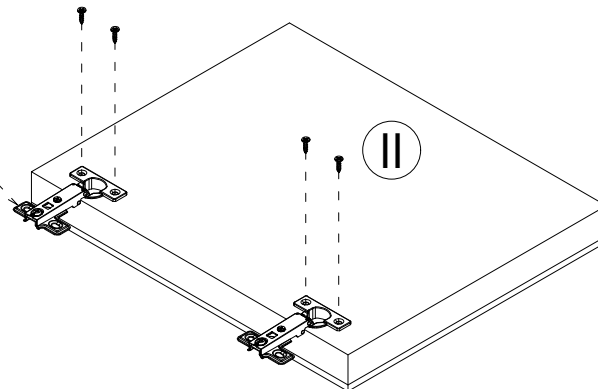
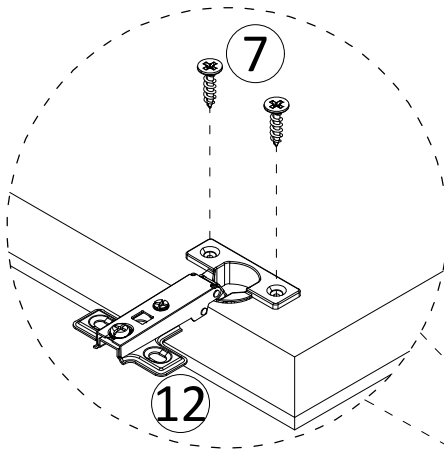
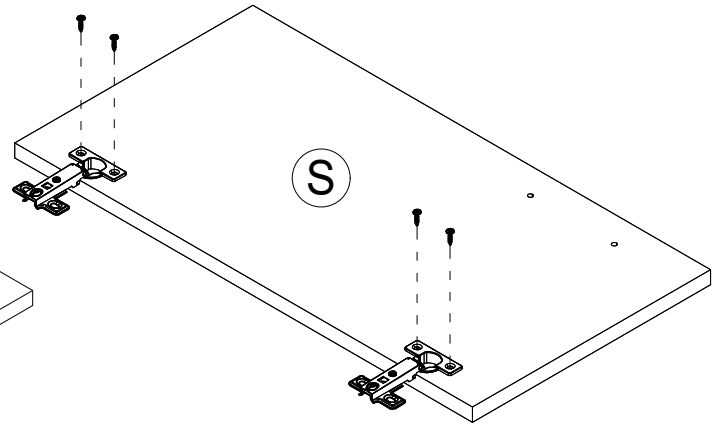
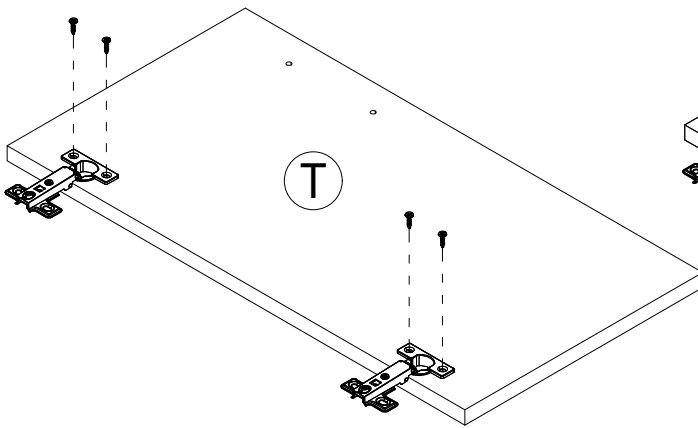
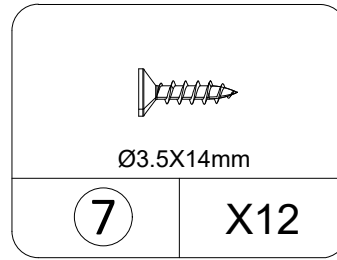
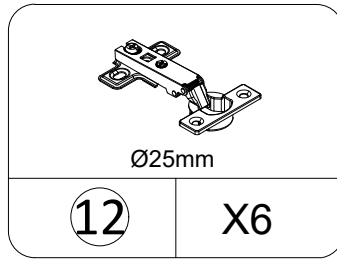
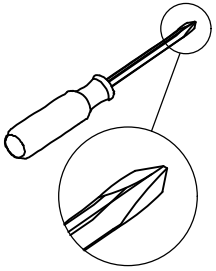

STEP24

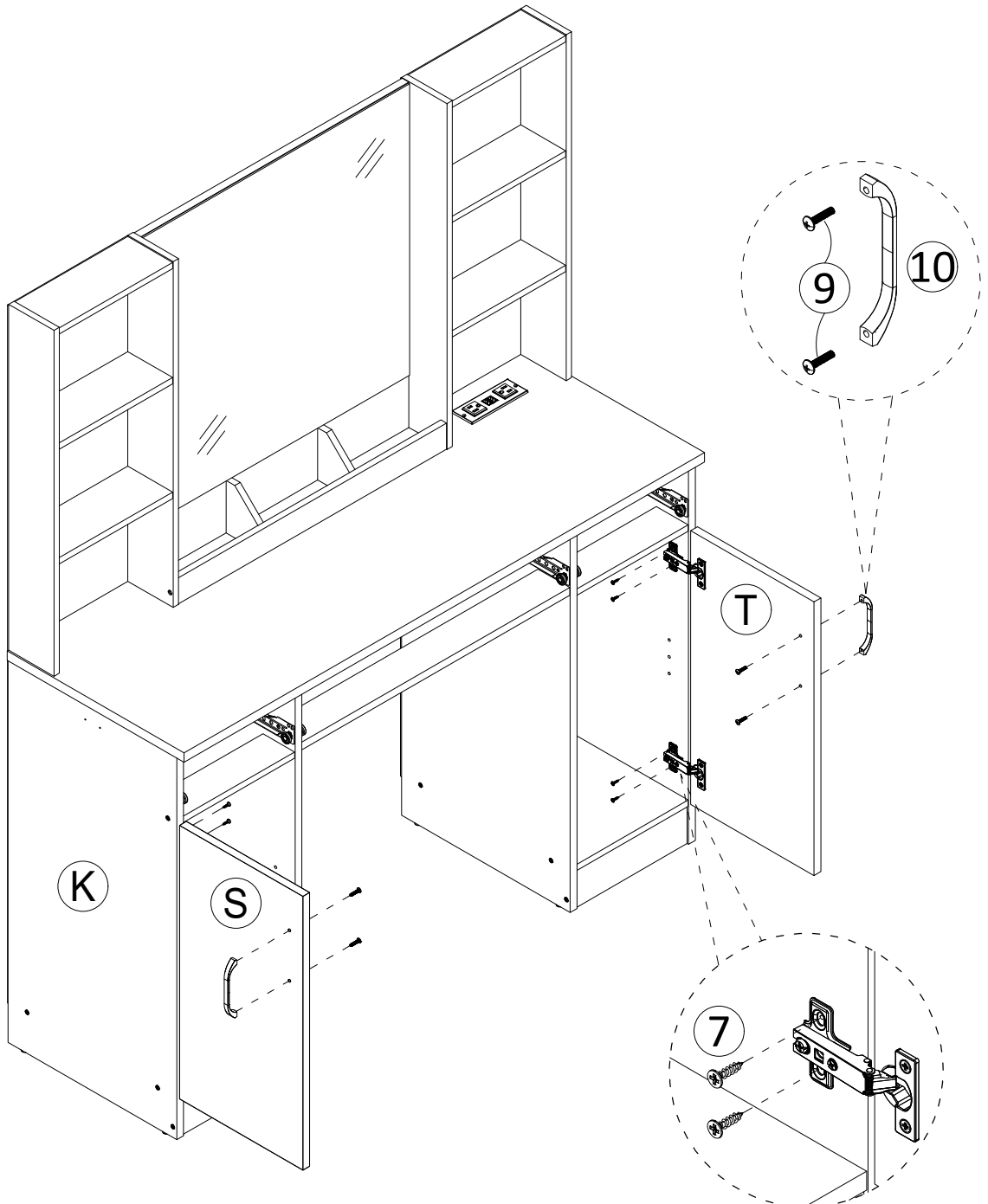
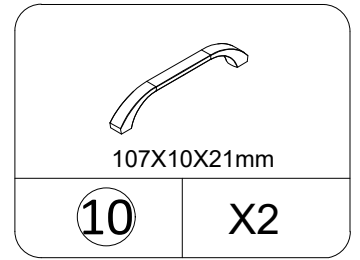
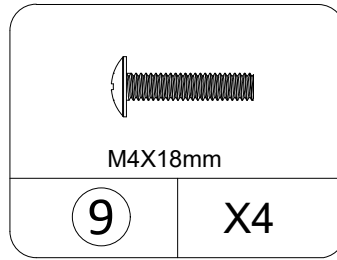
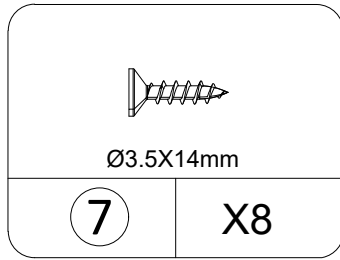
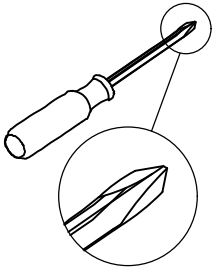

STEP 25

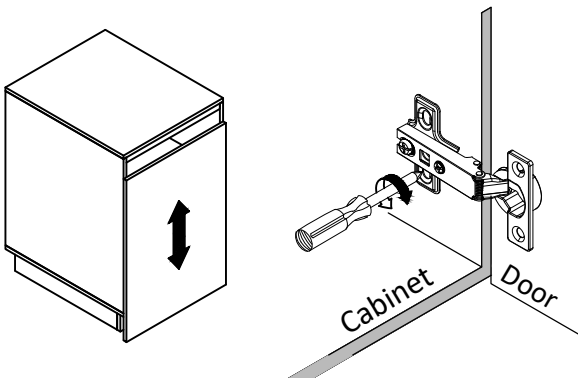
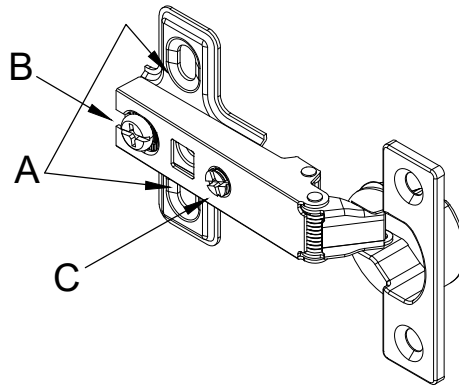

To adjust the vertical height.
Loosen the four screws "A" on both hinges.
Two of them are usually in slotted holes which allows you to adjust up or down by a few mm.
Then tighten back up.

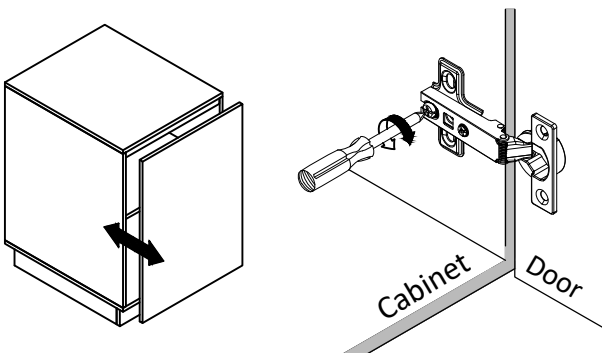

To adjust depth.
Loosen screw "B" and adjust door, if the door can not be adjusted, please loosen screw "C", then try again. Tighten screw "B" and "C".

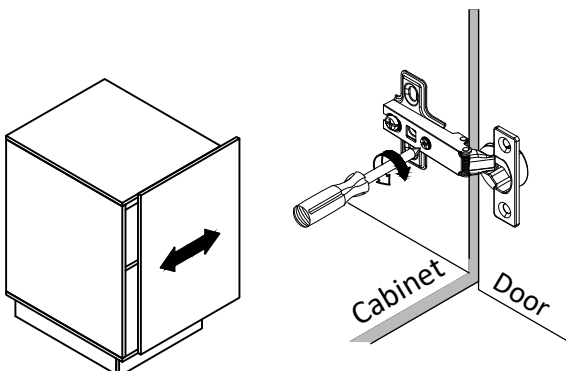

To adjust side ways.
Turning the screw "C" on BOTH hinges on each door.

STEP 26

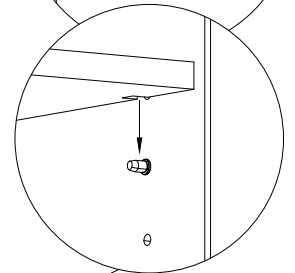
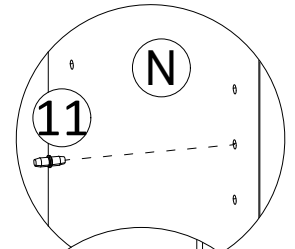
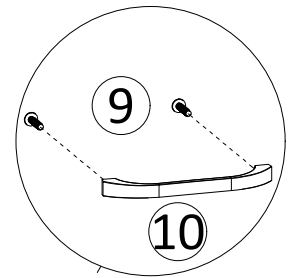
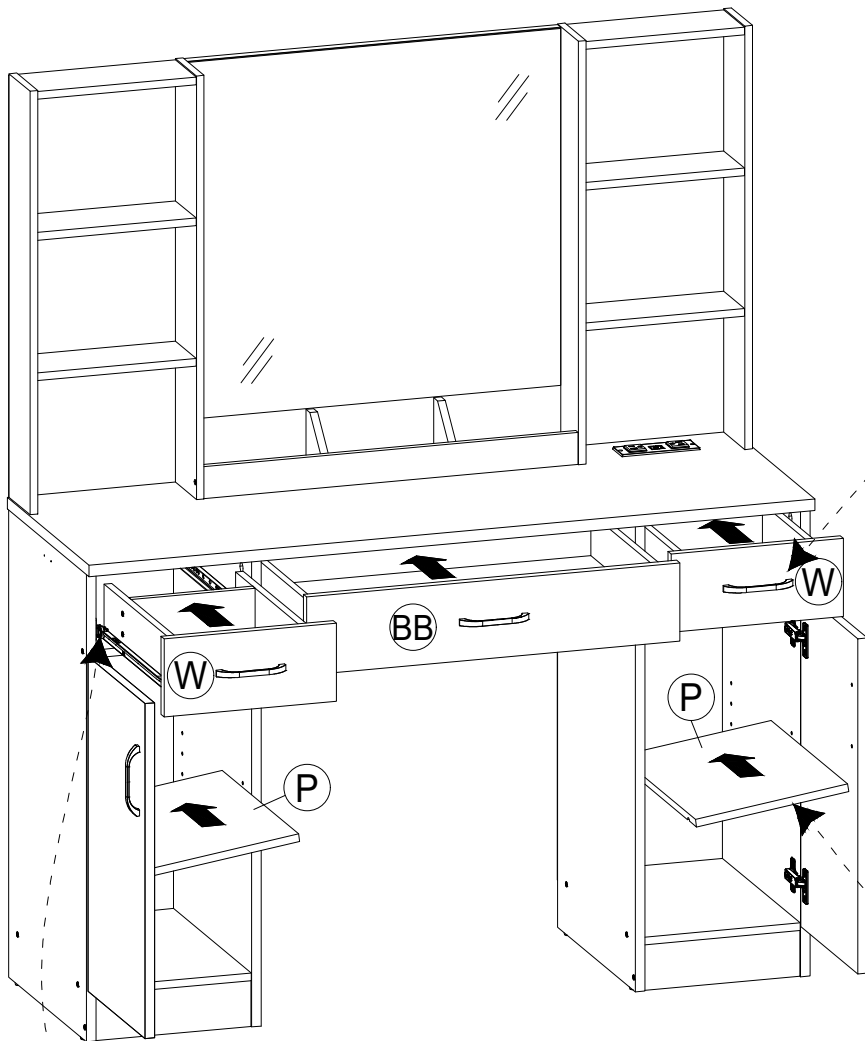
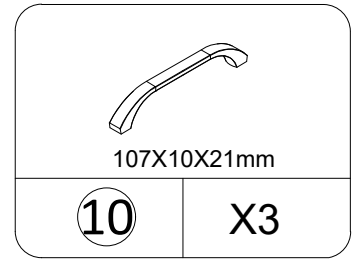
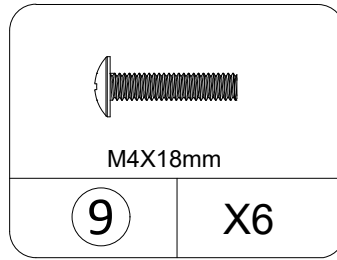
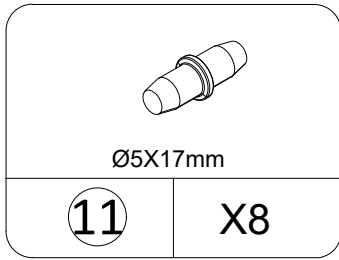
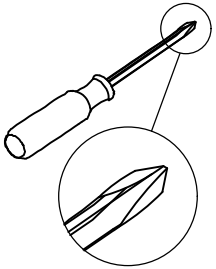

Cabinet Slide

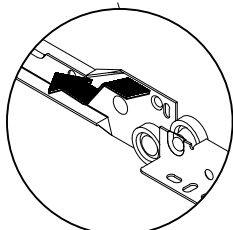

Drawer Slide

STEP 27

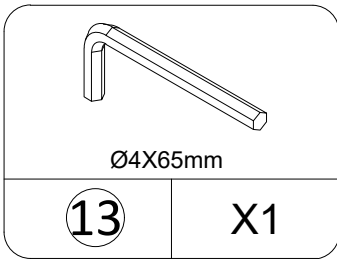
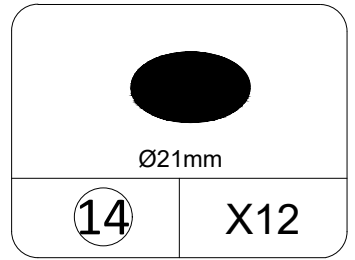
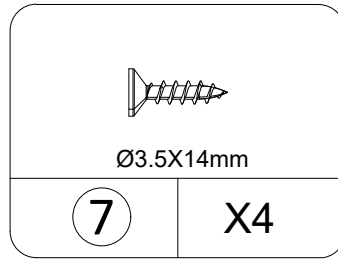
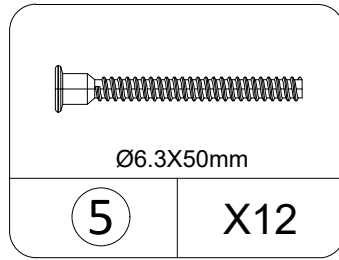
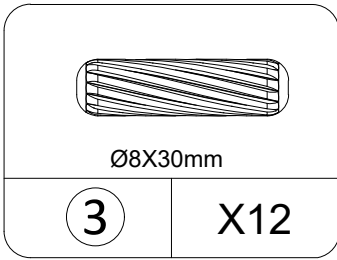

Note: the hole faces inward

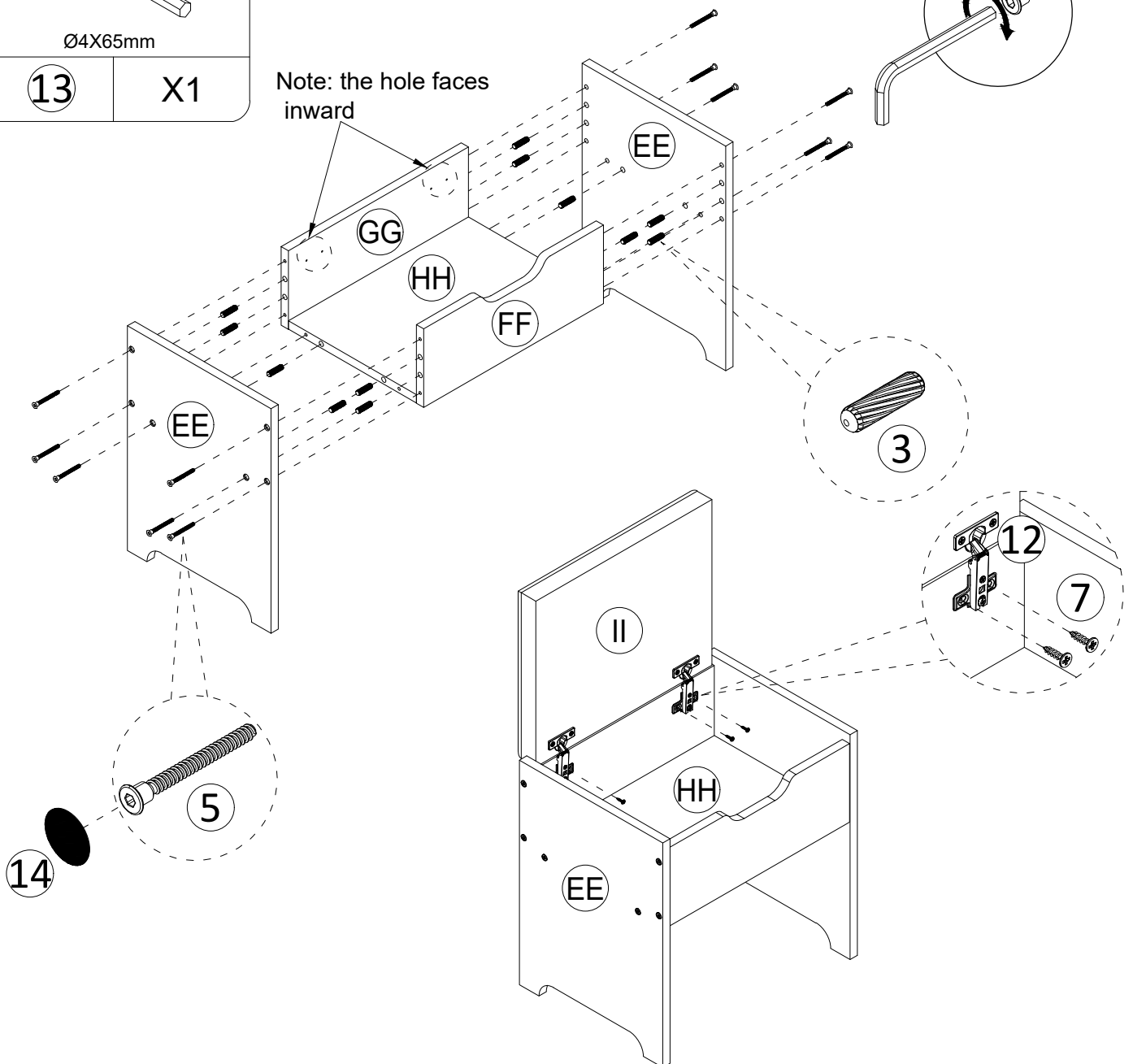

STEP28

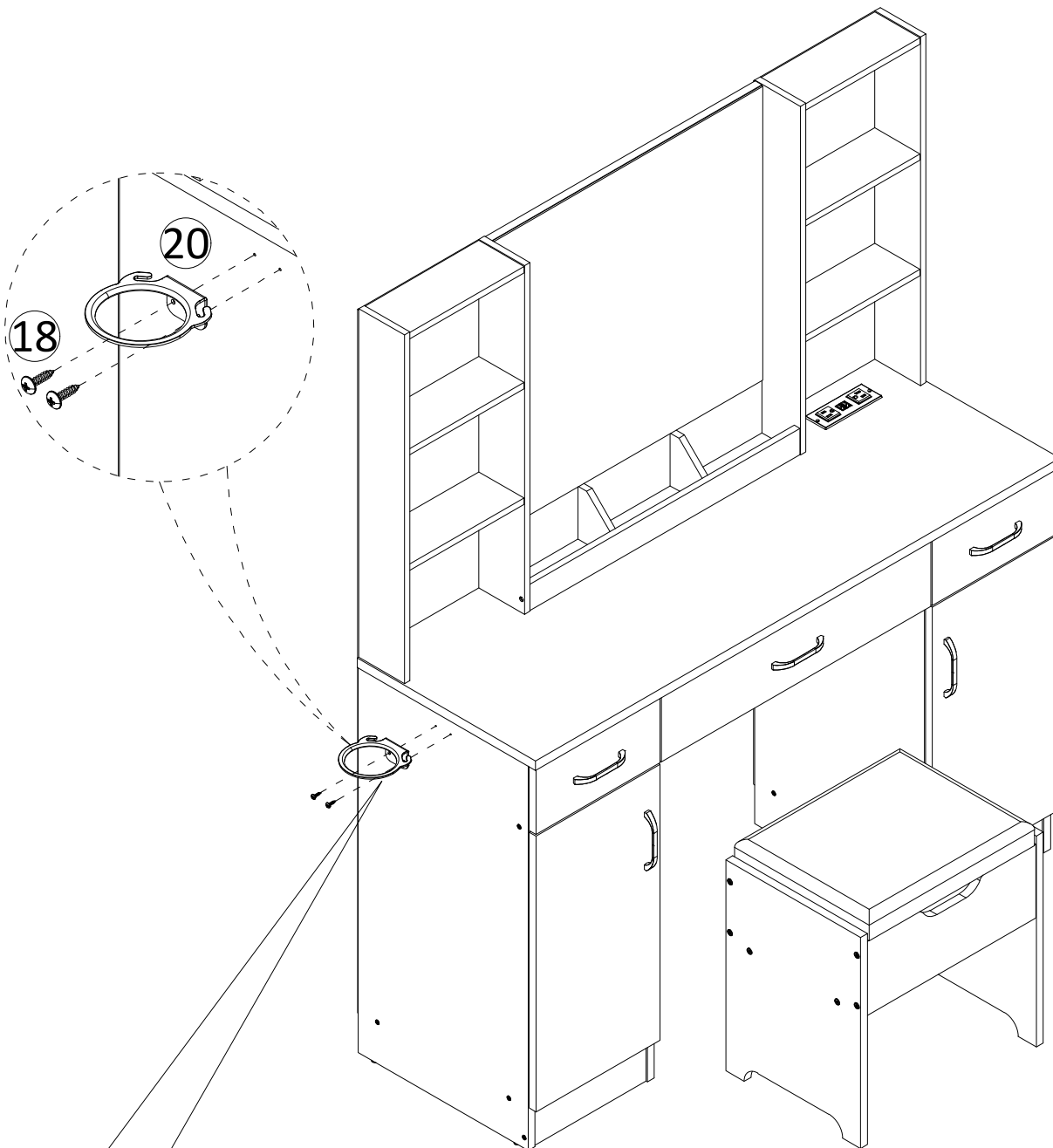
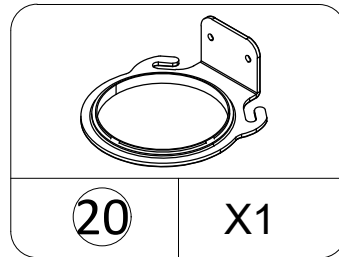
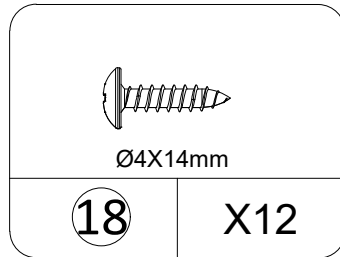
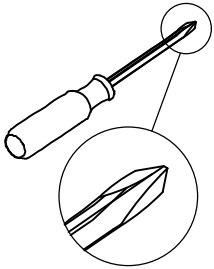

You can install the hair dryer rack(20) on the left or right according to your needs

STEP29

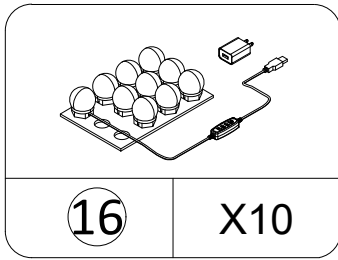

For specific installation and debugging, please read the last two pages

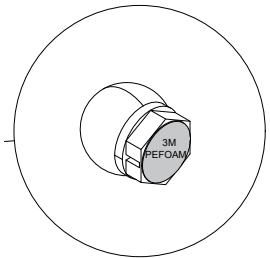
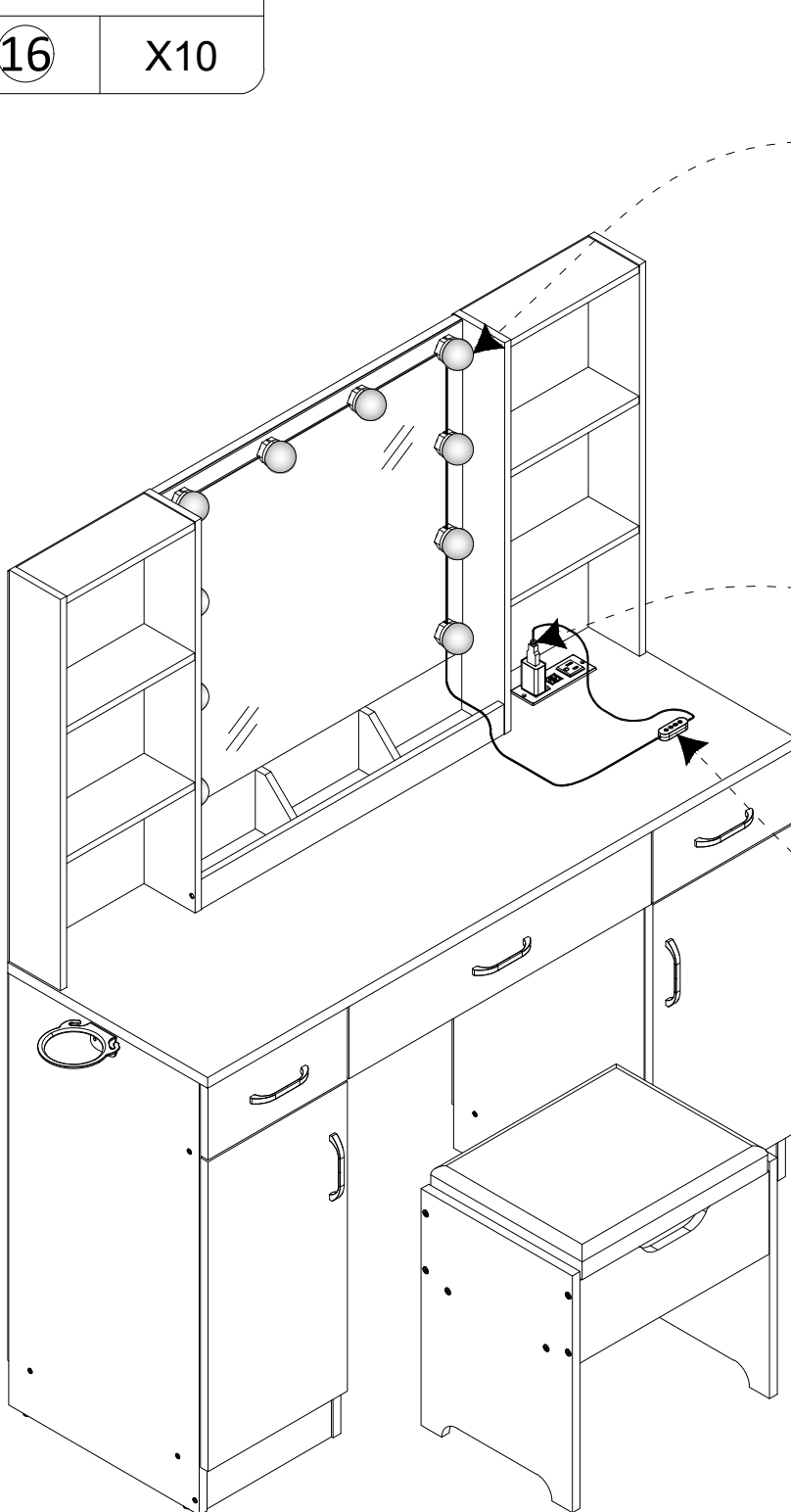

ABS lamp holder

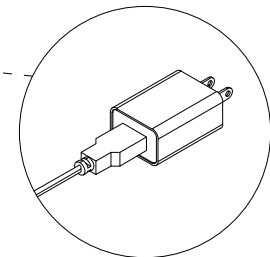

USB power adapter

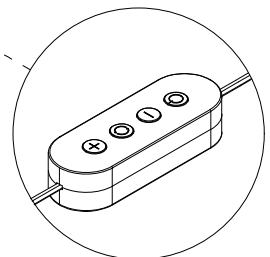

Switch regulator

STEP30

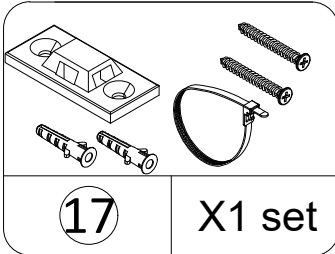

We have included a set of tipping restraint hardware for this unit. You must install this hardware to prevent accidents or injuries that can result from the unit falling. When properly installed, this restraint can provide protection against the unexpected tipping of the unit due to small tremors, bumps or climbing. We strongly recommend mounting this hardware to a wall stud and your unit.



NOTE:The tipping restraint hardware included is for wooden stud wall construction. It must be attached to a wall stud. Depending upon your wall construction different anchor hardware maybe required. Please contact your local hardware store for assistance. Young children can be seriously injured by tipping furniture. You must install the tipping restraint hardware with the unit to prevent the unit from tipping, causing any accidents or damage. The tipping restraints are intended only as a deterrent and are not a substitute for proper adult supervision. The tipping restraints are not earthquake restraints. If you wish to add the extra security of earthquake restraints, they must be purchased and installed separately.



Install the tipping restraint hardware

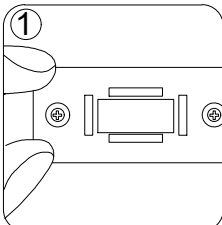

1. make mark on the wall

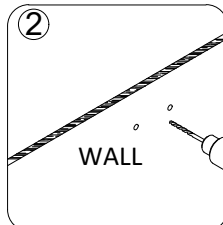

2. drill two $\varnothing 6$ holes on the wall

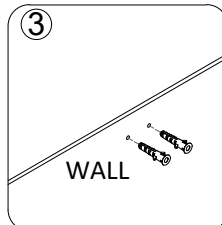

3. put two anchors in the holes

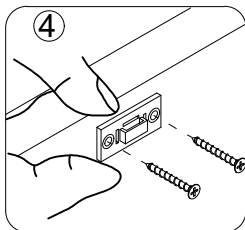

4. fix the device on the wall by the long screws

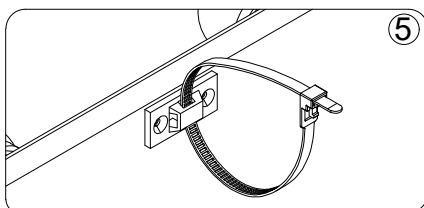

5. Push the cabinet close to the wall so that the two bases are close to each other, and then put on nylon tie to tighten it.

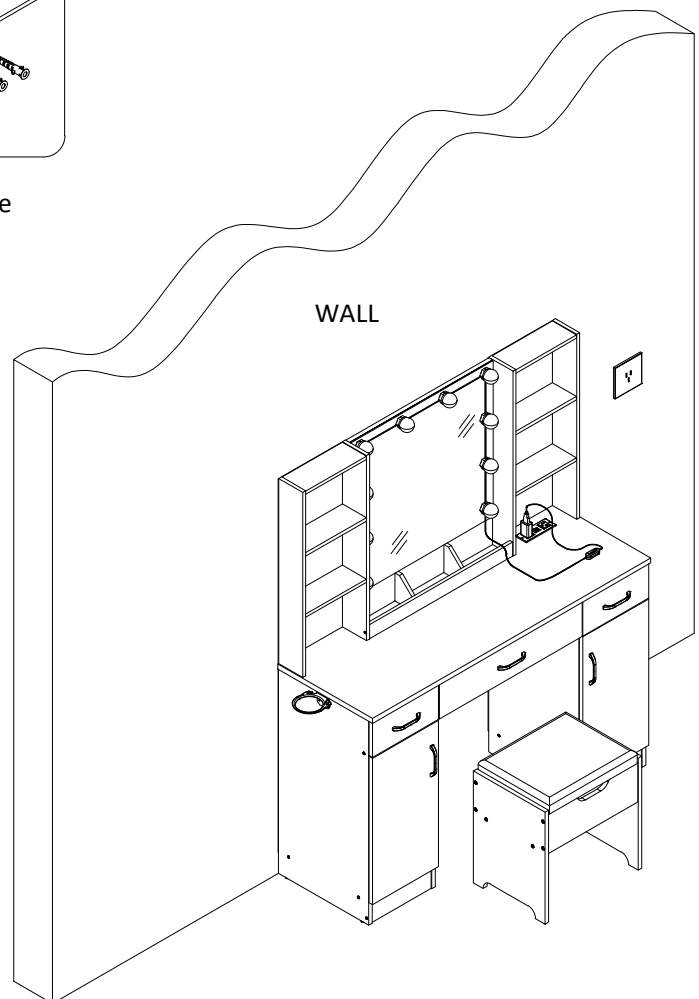

CONTINUED

Thank you for purchasing our company's DIY makeup mirror fill Light products, this product supports DIY own home mirror, instantly make their own mirror into a modern fashion makeup with LED Fill mirror. Even more interesting is that you can adjust the color temperature by yourself !

Product Features:

1. The standard USB power supply,safety voltage.
2. PC soft mask,don t stab the eyes.
3. All transparent lines,beautiful and stylish.
4. Multilevel luminance adjustable ,beauty skin and beauty face.
5. The color temperature is adjustable with the buttons.
6. By rotating the bulbs, the excess connecting wire can be hidden in the bottom shell make the installation more simple and beautiful.

Product parameters:

Product Name:Vanity Mirror Lights.

Bulb Size: 50 X 50 X 55 mm.

Power Supply:Standard USB 5V 2A or above.

LED colour temperature : 3000K/4500K/6500K

Power: a single lamp maximum power is 0.8W.

Material: ABS lamp-holder and PC lampshade.

Wisdom in design:

Rotate the bulbs clockwise or anticlockwise, the ball bubble spacing becomes shorter, the connection line shrinks and hides in the ball bubble bottom cover.Simple and beautiful installation, use more comfortable.

Rest assured dressing:

USB 5V low voltage power supply,safe! Multilevel luminance adjustable,suitable for different dressing needs.

Three kinds of color temperature can be adjusted :Warm White,Natural White and Pure White .

Vanity Mirror Lights

The color temperature is adjustable

Instructions

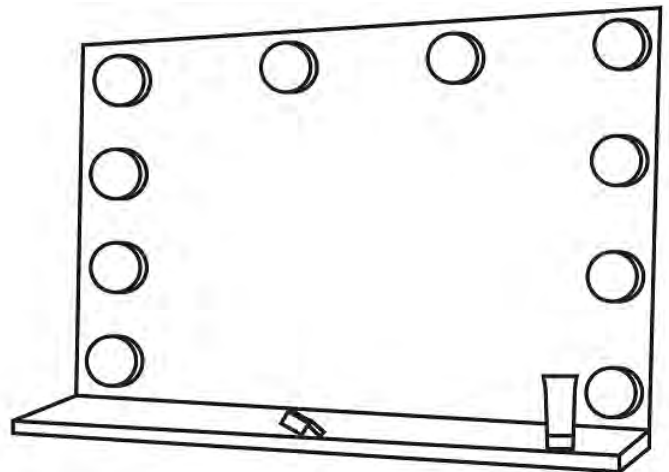

See Yourself Better!!!

Wisdom in design, Enjoy your life!

CONTINUED

Use the installation details see inside pages.

Functional Description:

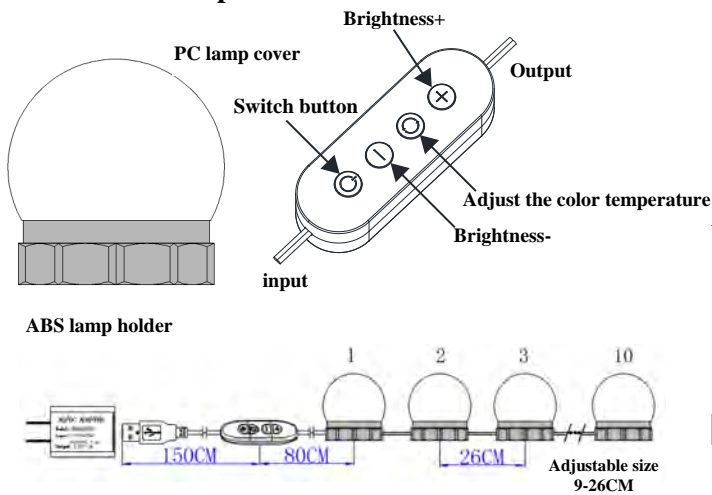

Application notes:

1. It is recommended to choose 2A or above USB power adapter, mobile phone charger and other standard USB mobile power can be use.
2. The product uses double-side adhesive paste installation of the bonding surface must be clean, dry, smooth, can not have rust and oil.
3. The wire can be adjustable through the winding between the base slot, and the bulb spacing can be adjusted between 9-26CM.

Reminded: When the bulb is pasted, please press the product for about 30 seconds, it takes 24 hours to achieve the best adhesive strength.

See Yourself Better!!!

Install reference diagram:

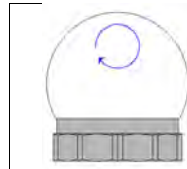
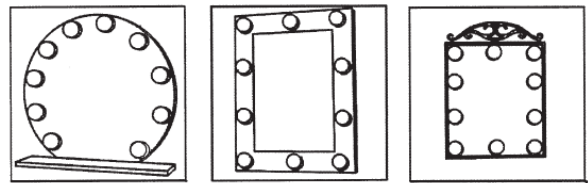

Special feature:

Rotate the bulbs clockwise or anticlockwise, the ball bubble spacing becomes shorter, the connection line shrinks and hides in the ball bubble bottom cover;
The USB port on the side of the control switch can charge the cell phone or other electrical appliances.

Installation steps:

1. Cosmetic mirror or be installed surface treatment : should be sticky surface should be dry, clean, and no rust, oxidation, grease, dust and other pollutants.
2. According to the design of the number of mirrors and bulbs, each bulb installation location, note the lamp spacing of up to 26 CM, the minimum spacing of about 9 CM.
3. Remove the product to determine the power and control switch to place the seat is appropriate to determine the first light paste location (with the control switch to connect the first line).
4. The bottom of the product is double-side adhesive tape tear off the film, and then affixed to the first lamp position, forced down, so that double-side adhesive is pasted better. Make the tape and the bonding surface get full contact.
5. After the installation, the rotating bulbs will shrink the redundant connecting wires and hide them in the bottom shell to ensure the simple and beautiful installation and achieve the best use effect.
6. When you use the lights, you can adjust the color temperature and the brightness with the function buttons. And choose your favorite color!