

INCLUDED PARTS:

(24) Arm Mounting Plates
 (24) Set Screws
 (1) Hex Wrench (for set screws)

(12) Arms
 (12) Arm Extension Tubes
 (3) Epoxy packs

(2) Bag (100) ties
 (1) 6ft x 100ft Heavy Duty Poly Fence Roll
 (2) Arm to Wall Straps

Please note:

Fasteners to attach the mounting brackets to your fence or wall are not included. The appropriate fasteners needed for different fence types are addressed within the instructions. *In addition, the components listed above are for a 100ft kit. If you ordered more or less than 100ft, your components may vary.*

1 ASSEMBLE THE ARMS AND ARM EXTENSION TUBES

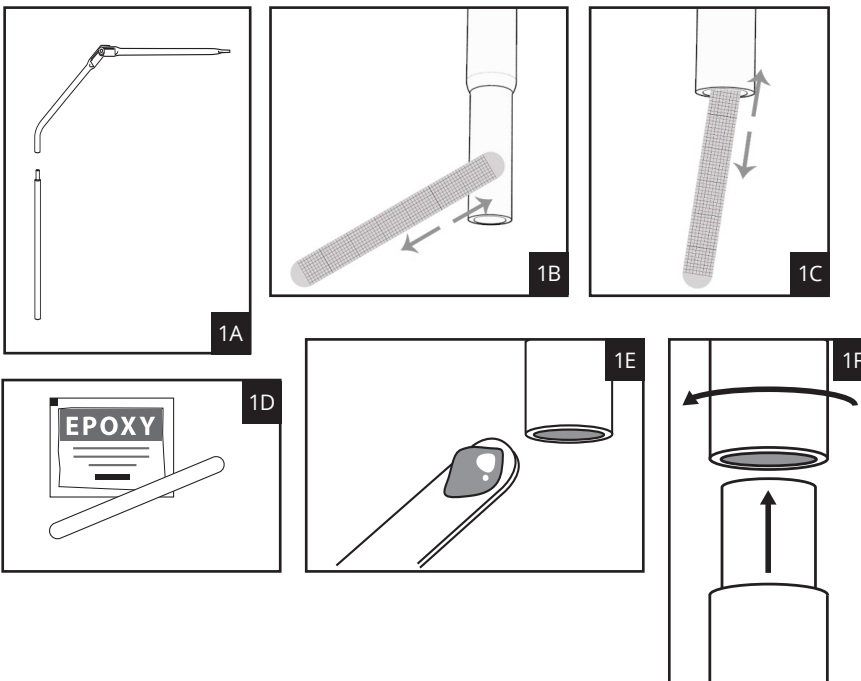

Permanent connection using epoxy

- 1A.** Lay the pieces out that require a permanent secure connection as shown
- 1B.** Use included sanding file to score (scuff up) the surface of the male end. Visibly light scratches are sufficient.
- 1C.** Use included sanding file to score (scuff up) the surface of the female end. Visibly light scratches are sufficient.
- 1D.** Mix a pack of epoxy (included)
- 1E.** Use the epoxy mixing stick to place a pea-sized amount of epoxy inside the bottom of tubing accepting the swage (female end)
- 1F.** Slide the swaged (male end) inside of the bottom of the femal end. Rotate the extension tube (1 full turn) to spread the epoxy and set aside for 15 minutes to cure.

Note: Each epoxy pack is good for 3-4 tube connections.

2 SECURE THE MOUNTING BRACKETS TO YOUR FENCE

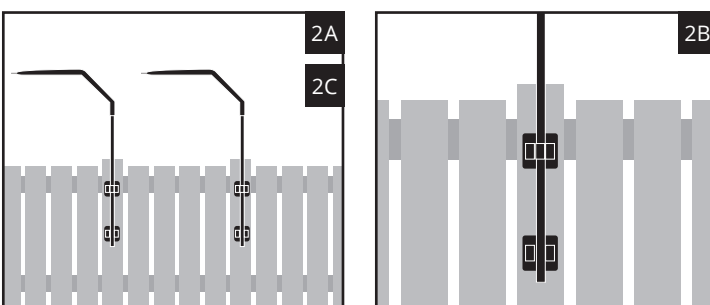

Determine Desired Fence Height

- 2A.** Each Arm / Extension assembly is secured with two mounting brackets on each of your fence posts.
- 2B.** The brackets should be at least 3" apart. They can be further if you are not trying to maximize overall Purrfect Fence height.
- 2C.** 6ft is the lowest recommended overall height

2 SECURE THE MOUNTING BRACKETS TO YOUR FENCE (CONTINUED)

FOR WOOD FENCES

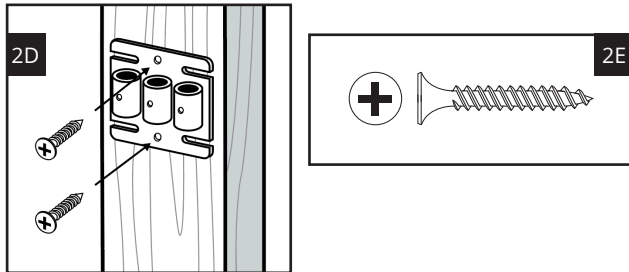

Secure The Brackets To The Fence

2D. Use 2 bugle-head screws (**2E**).

FOR METAL FENCES (WITH ROUND OR SQUARE POSTS)

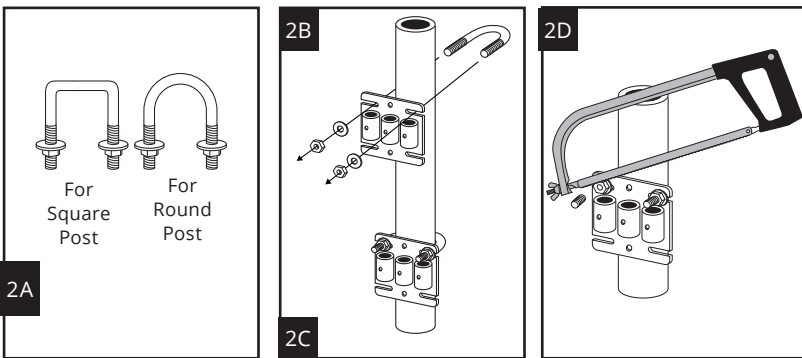

Secure The Brackets To The Fence

- 2A.** Use appropriate U-bolt to attach the bracket to your fence post.
- 2B.** Only one U-bolt is needed per bracket.
- 2C.** Use two brackets per tube
- 2D.** Use a metal hacksaw to remove the excess u-bolt to ensure that the arms will fit in the outer mounting plate holes

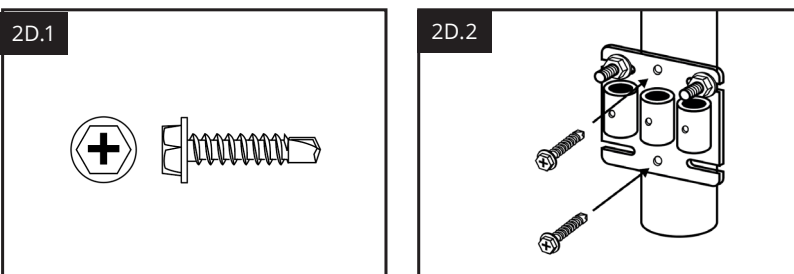

Secure The Brackets To The Fence Option

- 2D.1** An option to cutting off excess U-bolt threading at gates and endpoints is to secure the bracket with self-tapping screws (not included).
- 2D.2** Once the self-tapping screws are installed, remove the U-bolts.

FOR VINYL / PVC FENCES

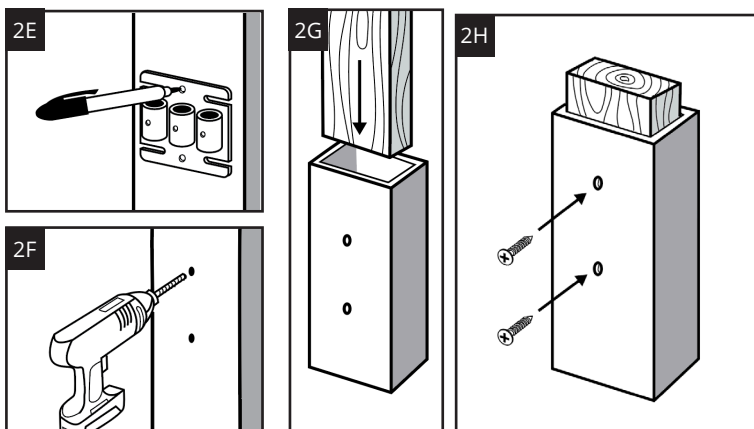

Secure The Brackets To The Fence

- 2E.** Mark where the bracket will need to be with a marker
- 2F.** Drill holes where you marked the fence post
- 2G.** Remove post cap and insert 12"– 18" long pressure treated wood.
- 2H.** Screw 1 ½ screw through the bracket and post into the wood.

2 SECURE THE MOUNTING BRACKETS TO YOUR FENCE (CONTINUED)

FOR MASONRY WALLS / BRICK

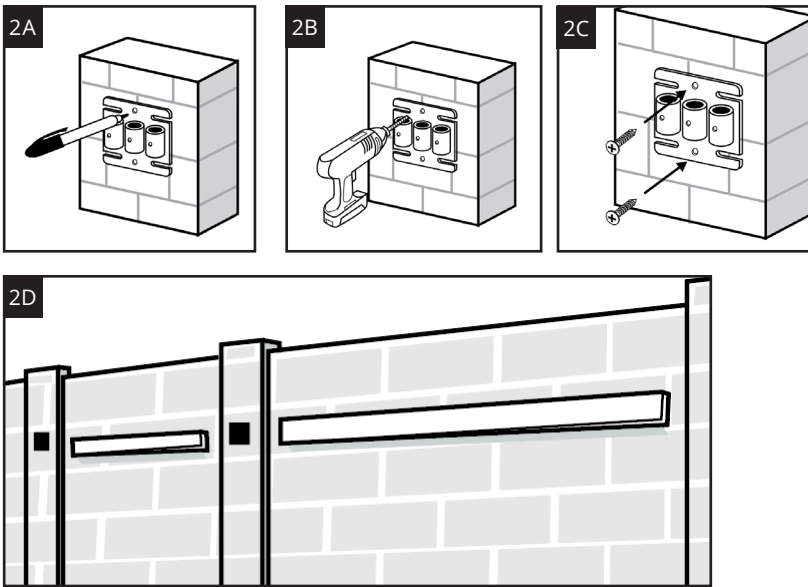

Secure The Brackets To The Fence

- 2A.** Mark where the bracket will need to be with a marker
- 2B.** Drill pilot holes with masonry drill bit (not included)
- 2C.** Screw bracket to wall with concrete screw (not included)
- 2D.** Secure wood strips (not included) between mounting brackets. The wood strip will be utilized in step 6.

3 INSERT ARMS / EXTENSION TUBES INTO THE MOUNTING BRACKETS

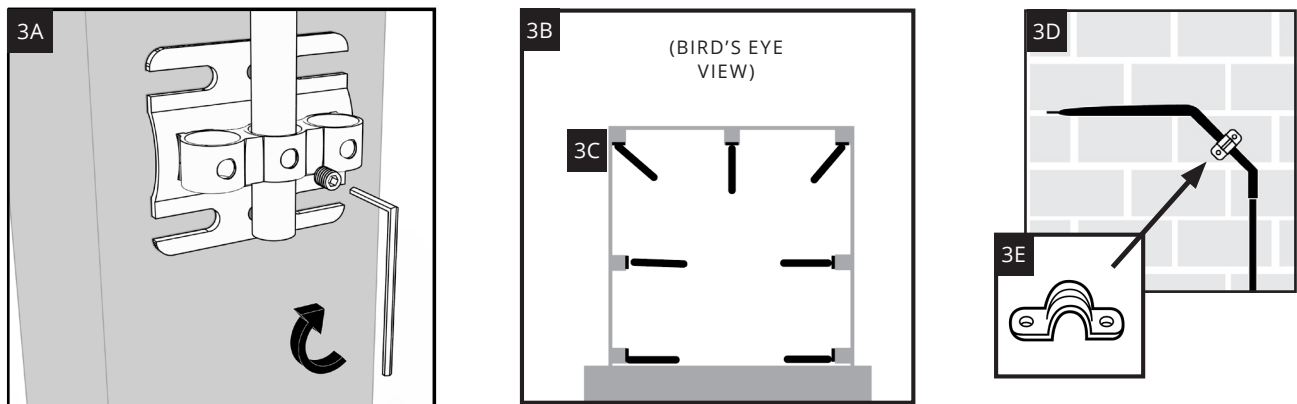

- 3A.** To secure arm extensions into brackets, slide tubing through the appropriate ring (Center in most cases. Left or right in corners, end points, and gate areas). Using the provided hex wrench, thread set screw into hole on front of ring.
- 3B.** Arms should point perpendicular to the fence line except for where the fence turns.
- 3C.** Arms in corners should point at 45° using the ring that will be closest to the center of the angle and extend farthest into the enclosure.
- 3D.** Where the fence ends at a building, the arm should be secured to the building by strapping the non-pivoting part of the arm just below the spring joint to the building using screws and the included straps (**3E**).

Note: Any of the 3 rings on the bracket can be used when necessary. Multiple arms can be used on the same bracket when needed for outside corners, gates, and more complex situations.

4 FOR OPENING GATES

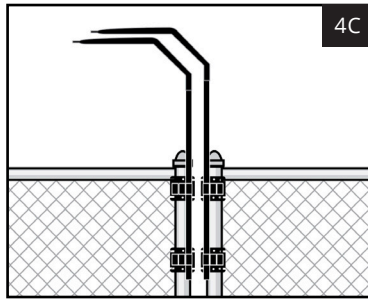
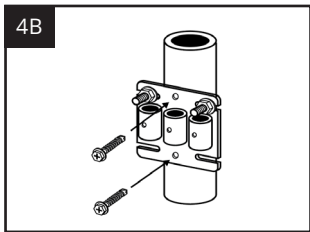
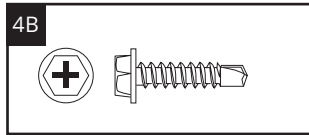
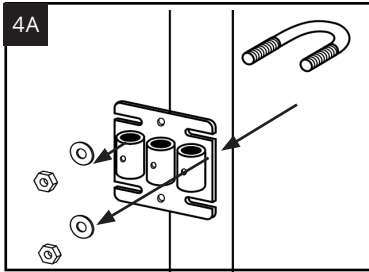

Secure The Brackets To The Gate

- 4A. Use appropriate U-bolt to hold the bracket to your gate post temporarily.
- 4B. Use self-tapping screws (*not included*) to secure the bracket to the gate post. Remove the U-bolts and insert the extension arm into the inner most bracket holes.
- 4C. For outward opening gates, stagger the heights of the arms by 2 inches so that they swing open freely.

5 ATTACH MESH FENCE MATERIAL

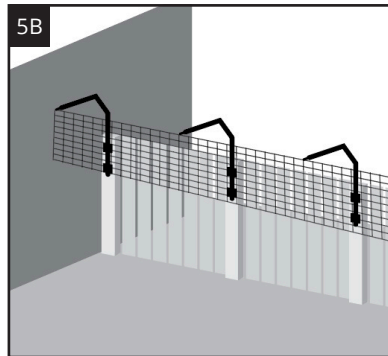
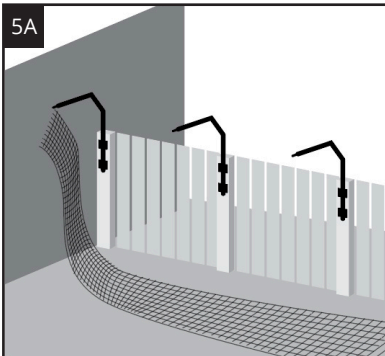

Install mesh fencing material one side at a time.

- 5A. Unroll the fence and lift it and hang the top edge of fence from the tips of the arms with the included zip ties. Do not try to pull it overly tight between arms.
- 5B. Now you have the fence hanging from the tips of all the arms on a side.

Inside Corners

- 5C. At corners the arms are angled relative to the rest of the arms in the sections which makes them "shorter". To adjust for this, attach the fence 4 squares in from the edge of the fence.

- 5D. Run the fence slightly past the corner and cut the fence off the roll.

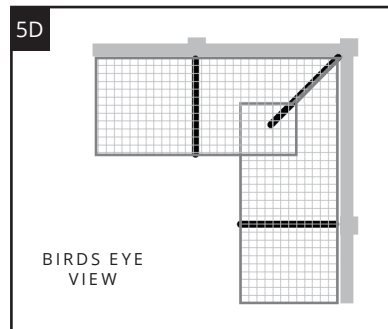
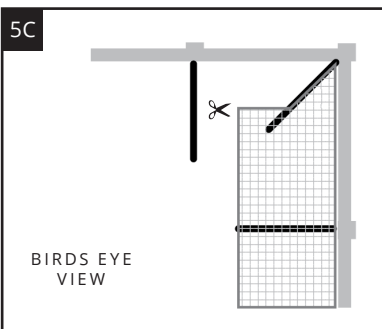

Outside Corners

- 4E. Outside corners require 1 (optionally 2) brackets and 2 arms.

- 4F. Cut fence on turns. A separate piece of fencing is required for the outside corner between the arms.

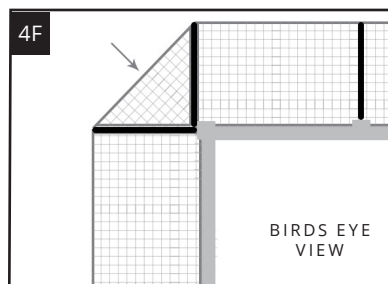
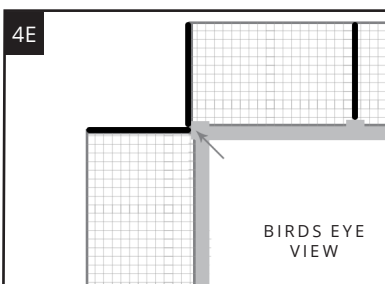

5 ATTACH MESH FENCE MATERIAL (CONTINUED)

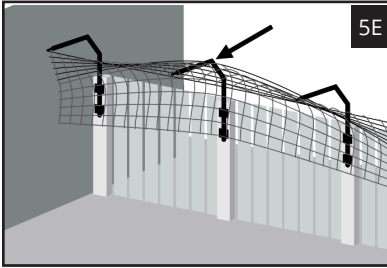

5E

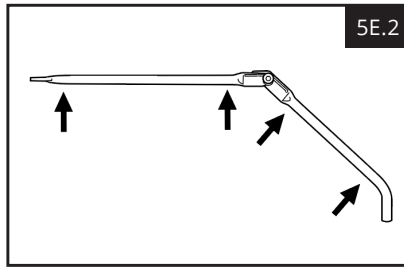

5E.2

Install mesh fencing material one side at a time

5E. Lift the middle of the fence up and zip-tie it to the arm where shown. (**5E.2**)

5F. Continue lifting fence and zip-tieing to the sides until all arms are secured to the mesh fence.

5G. At gates, cut the fence between the arms to allow the gate to open.

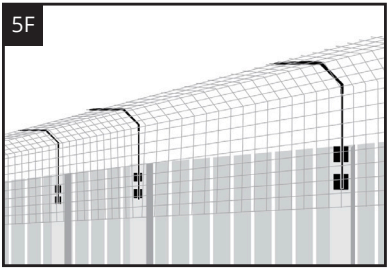

5F

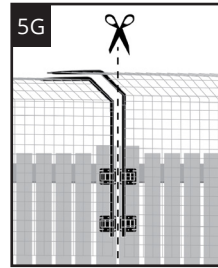

5G

6 SECURING BOTTOM OF MESH FENCE

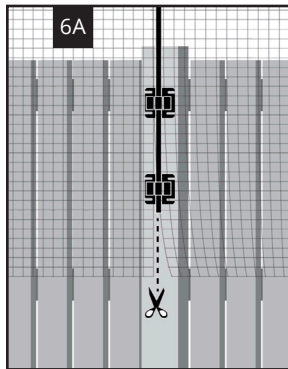

6A

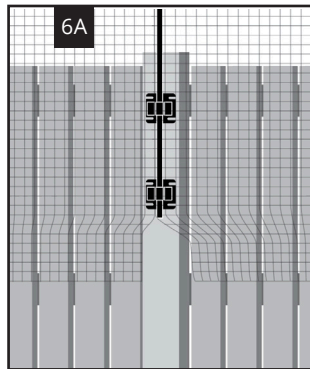

6A

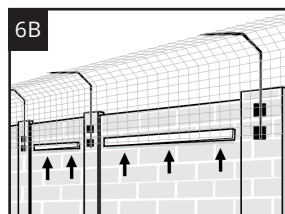

6B

6A. Wood Fence - When the mounting bracket is secured to the post, cut the fence vertically at post below the mounting bracket. Staple the mesh fence (staple gun, not included) and cut off the excess fence.

6B. Masonry Wall - Staple the bottom edge of fence off to the wood strip installed at "Step 2D".

6C. For Metal Fences - Secure the bottom of mesh fence to the metal fence with zip ties or hogrings (hogringer & rings sold separately)

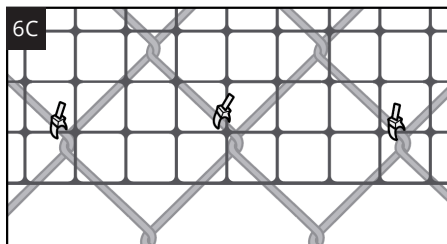

6C

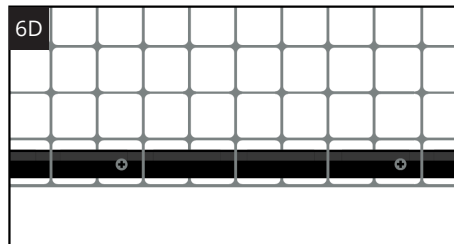

6D

<http://store.purrfectfence.com/product-p/hogringer-rings.htm>

6D. Vinyl / PVC fence - Use "PVC/Wall kit" (sold separately).

<http://store.purrfectfence.com/product-p/pvc-wallkit.htm>