

INSTALLATION

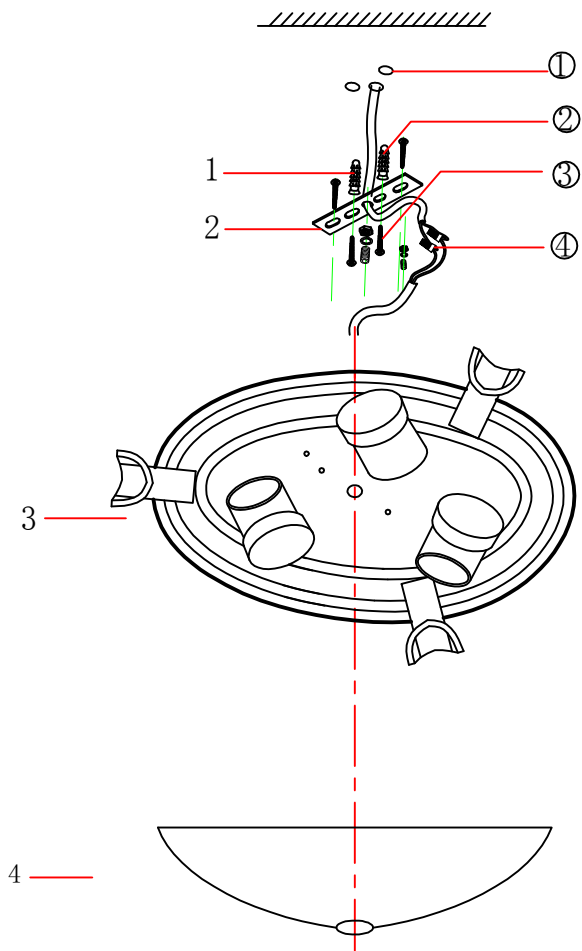

Ceiling Lamp

100-240V
50Hz/60Hz
MAX:60W

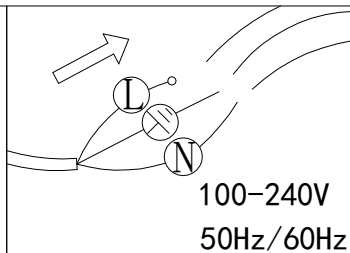

Installation:

- ① Drill a hole in the ceiling.
- 2 Insert the expansion bolt in the ceiling.
- 3 Mount the crissbar by screws.
- 4 Connect the cable.
- 5 Mount the bracket.
- 6 Put the lamp shade and light source.

Cautions:

- ◆ Should be installed by professional person
- ◆ During the cleaning and installation remember to cut the power off
- ◆ Keep the lamps away from corrosive chemical and air such as acid and alkali.
- ◆ Do not wash it with water, but wipe it clean with a soft cloth.

Accessory List

No	Part Name	Photo	QTY
1	Screw		1
2	hanging board		1
3	Light Source		1
4	The lampshade		1