

J x 2

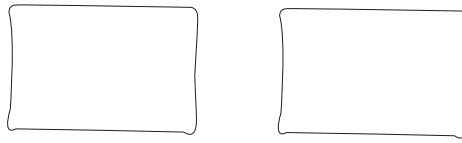

I



J

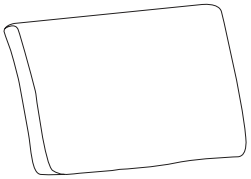

G

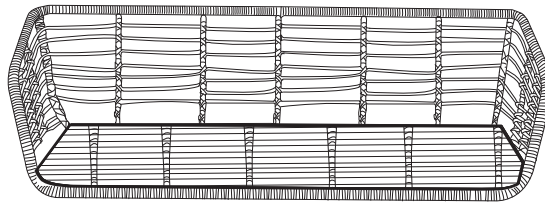

J

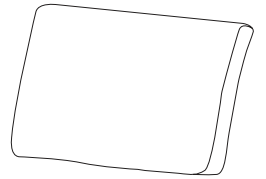

H



H



D

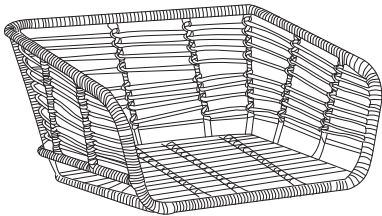

F x 2

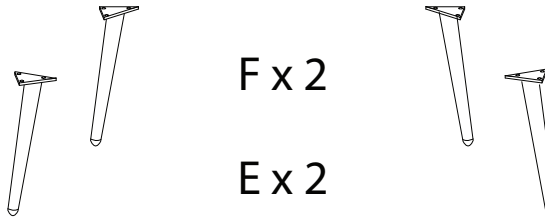

E x 2

C



D

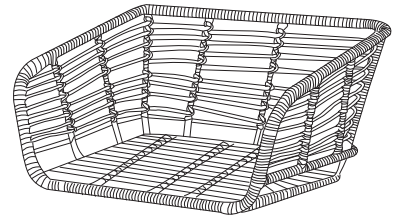

F x 2

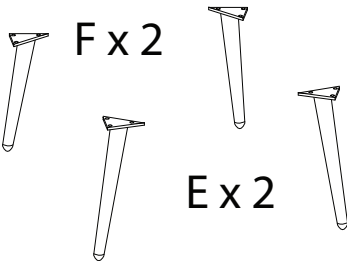

E x 2

A

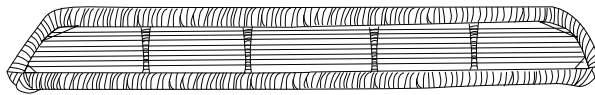

F x 2

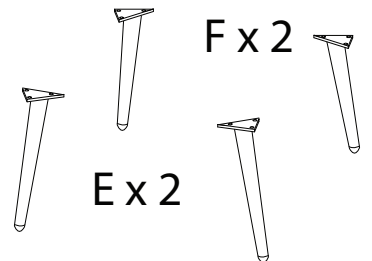

E x 2

B x 4

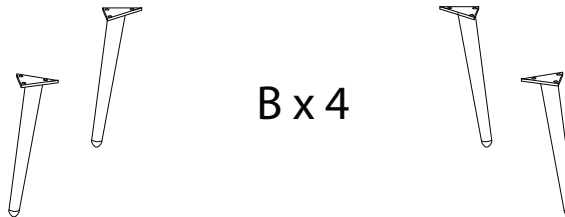

A

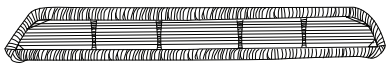

x 1

B



x 4

C



x 1

D

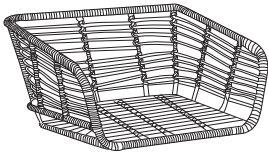

x 2

E



x 6

F



x 6

G

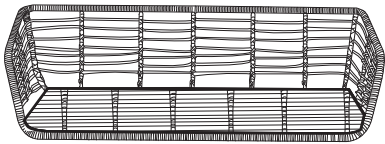

x 1

H



x 2

I



x 1

J

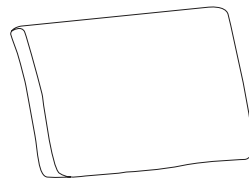

x 4

1

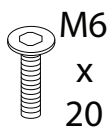

x 48

2





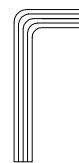

x 48

3

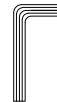

x 1

1



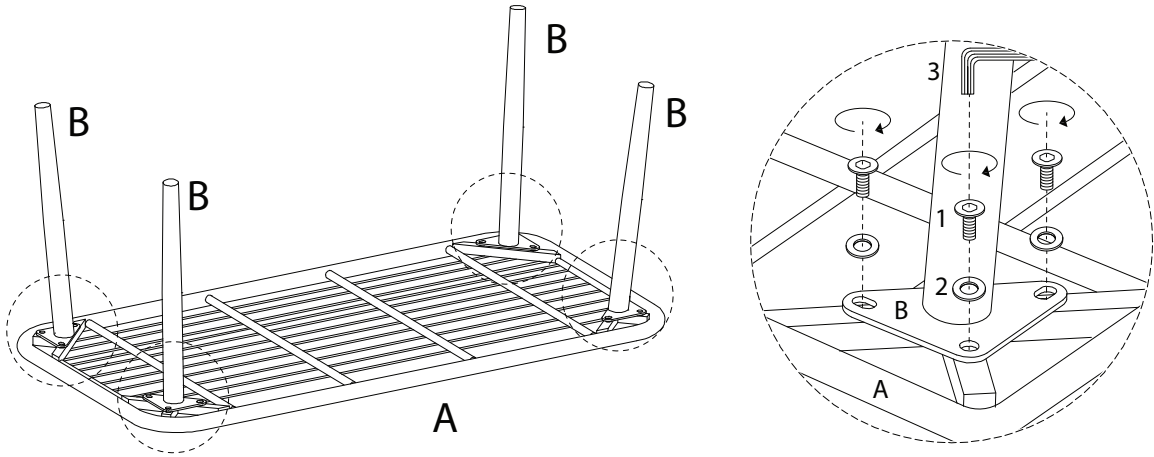

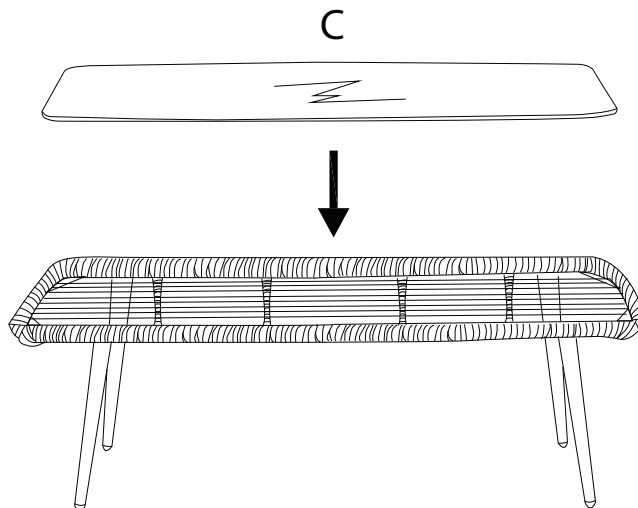
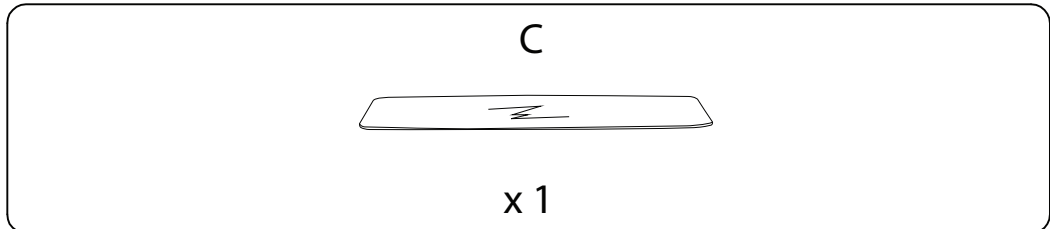

<p>1</p>  <p>M6 x 20</p> <p>x 12</p>	<p>2</p>  <p>x 12</p>	<p>3</p>  <p>x 1</p>	<p>A</p>  <p>x 1</p>	<p>B</p>  <p>x 4</p>
---	--	---	---	---



2

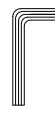

3 x 2

1  M6 x 20 x 12	2  x 12	3  x 1	D  x 1	E  x 2	F  x 2
--	--	---	--	---	---

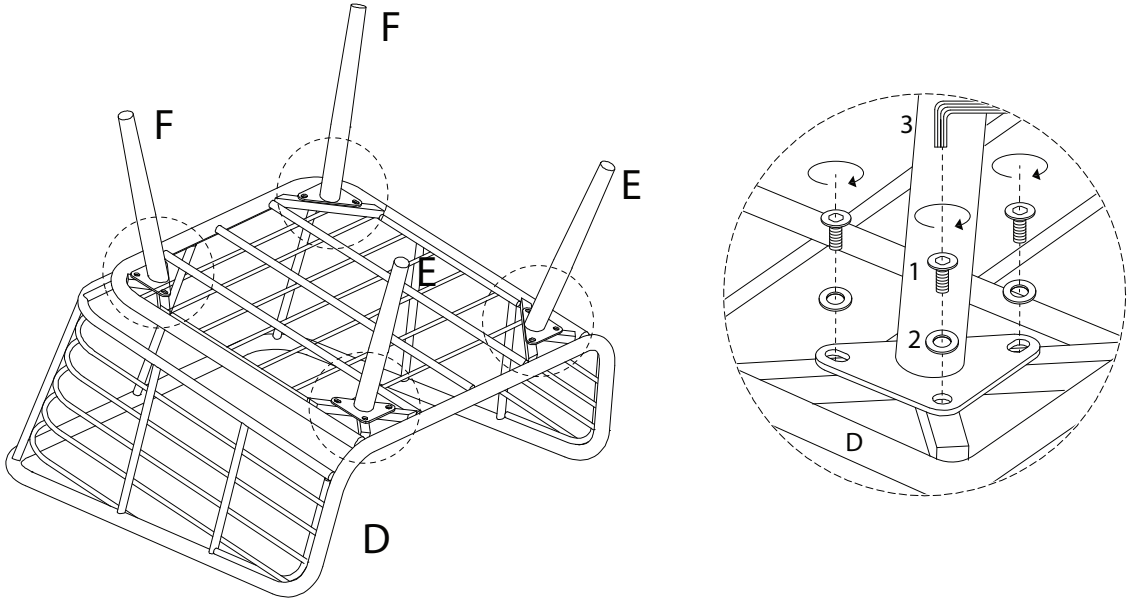



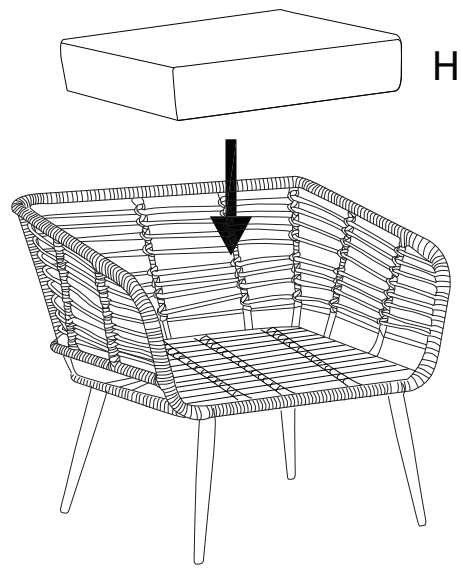
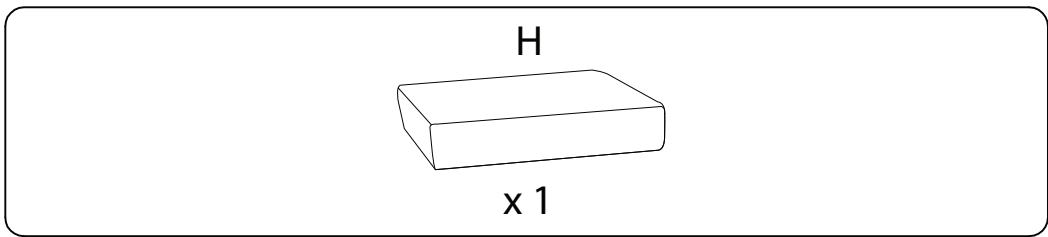

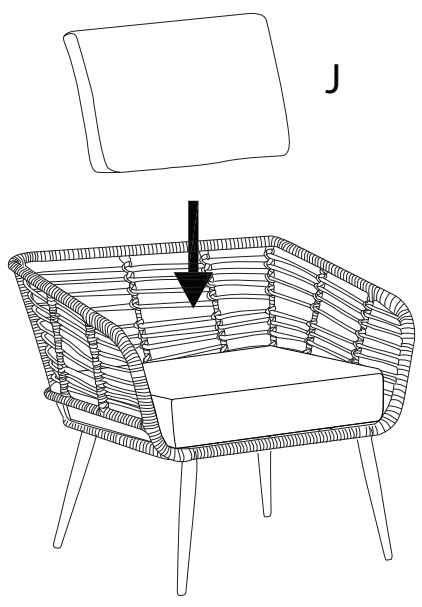
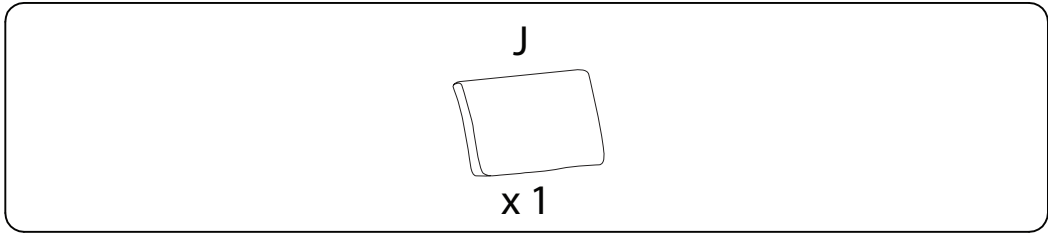

4 x 2



5 x 2

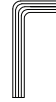

6

<p>1</p>  <p>M6 x 20</p> <p>x 12</p>	<p>2</p>  <p>x 12</p>	<p>3</p>  <p>x 1</p>	<p>E</p>  <p>x 2</p>	<p>F</p>  <p>x 2</p>	<p>G</p>  <p>x 1</p>
---	--	---	---	---	---

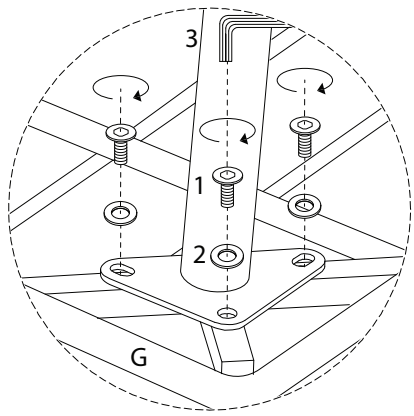
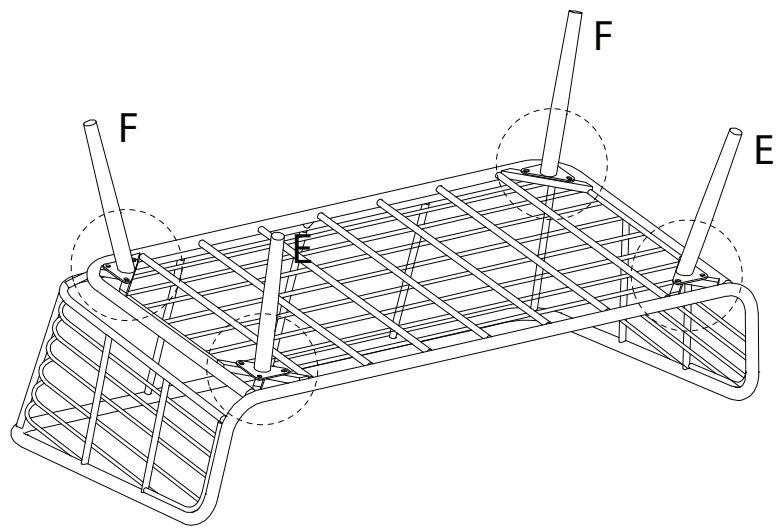

7

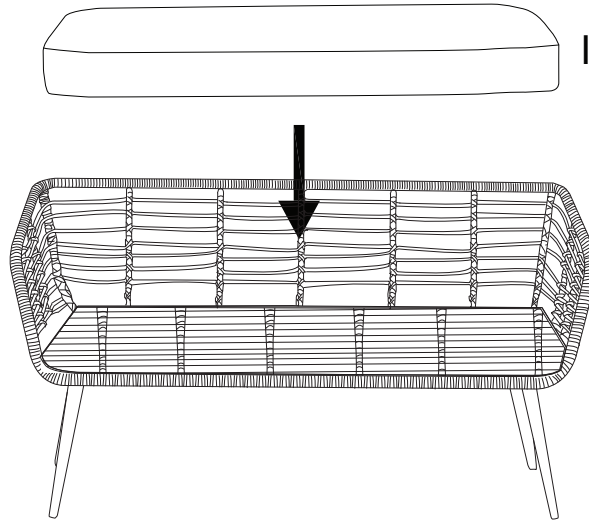
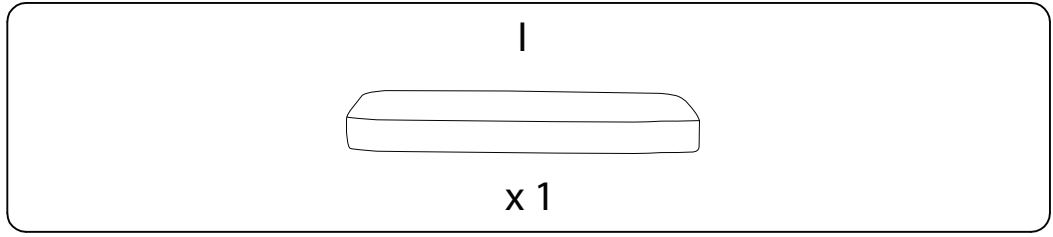

8

