

ASSEMBLY INSTRUCTIONS

BUNK BED

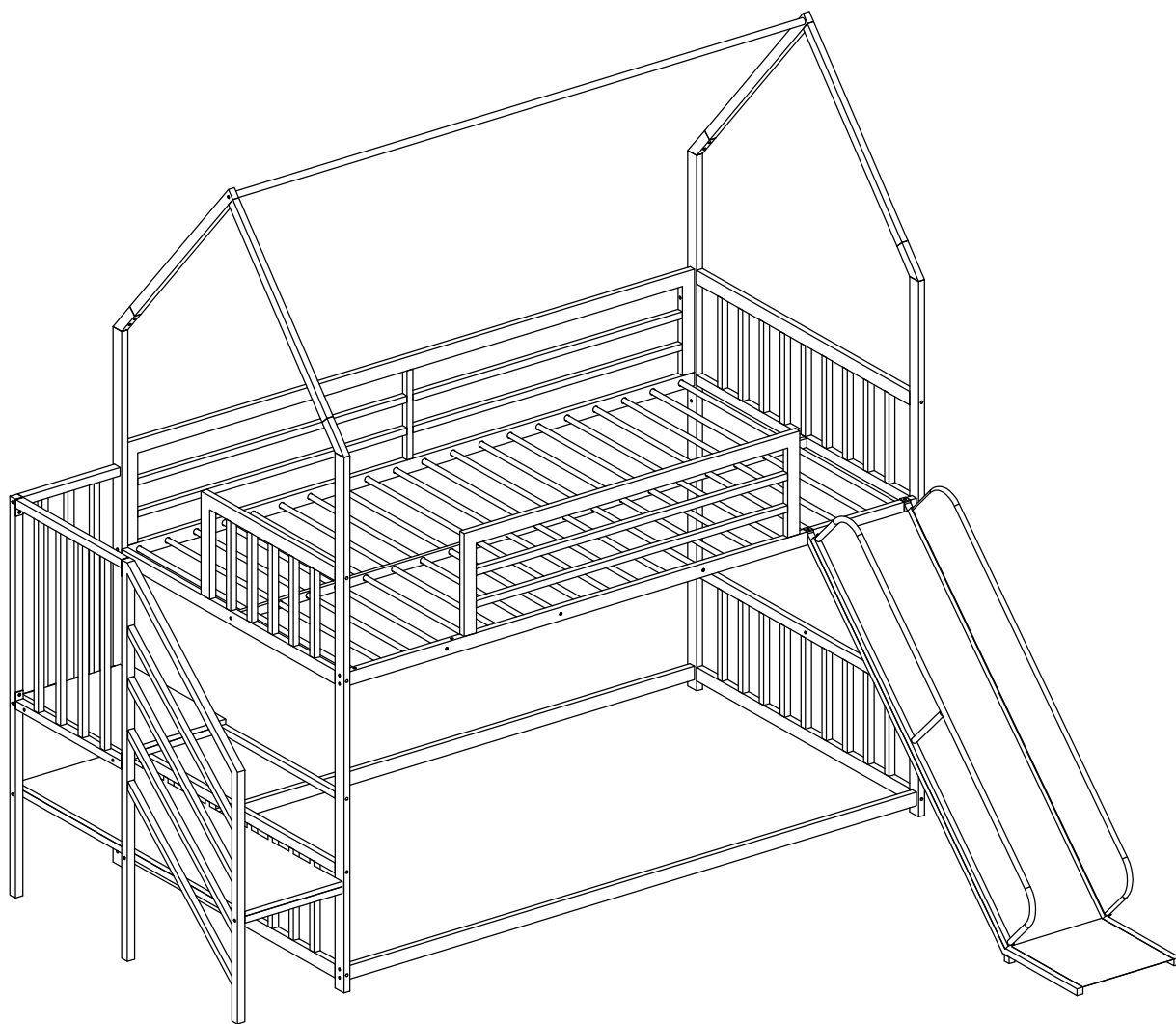

SAFETY WARNINGS AND GENERAL NOTES:

1. Follow the information on the warnings on the upper bunk bed end structure and on the carton. Do not remove the warning label from the bed.
2. Always use the recommended size mattress or mattress support, or both, to help prevent the likelihood of entrapment or falls.
3. Do not allow children under 6 years of age to use the upper bunk.
4. Periodically check and ensure the guardrail, ladder and other components are in their proper position, free from damage, and all connectors are tight.
5. Do not allow horseplay on or under beds.
6. Always prohibit jumping on the bed.
7. Prohibit more than one person on upper bunk.
8. Always use the ladder for entering and leaving the upper bunk.
9. Do not use substitute parts. Contact the manufacturer or dealer for replacement parts.
10. Use of a night light may provide added safety precaution for a child using the upper bunk.
11. Always use guardrails on both long sides of the upper bunk.
12. If the bunk bed will be placed next to a wall, the guardrail that runs the full length of the bed should be placed against the wall to prevent entrapment between the bed and the wall. The use of water or sleep flotation mattresses is prohibited.
13. **STRANGULATION HAZARD**-Never attach or hang items to any part of the bunk bed that are not designed for use with the bed; for example, but not limited to, hooks, belts and jump ropes.
14. Keep these instructions for future reference.
15. We recommend assembling your bunk bed on the shipping carton to protect your floor or carpet.
16. Be certain all staples are out of the box before beginning assembly on the shipping carton.
17. **USE ONLY MATTRESSES WHICH ARE AS THE TABLE BELOW ON UPPER AND ON LOWER BUNKS.**
Upper bed(bunk bed and triled included)

Bed type	Length	Width	Thickness
Twin Standard	75"	39"	6" max
18. **SURFACE OF MATTRESS MUST BE AT LEAST 5" (127MM) BELOW THE UPPER EDGE OF GUARDRAILS.**
19. **Replacement Parts:**
Replacement Parts, including additional guardrails, may be obtained from any of our dealer

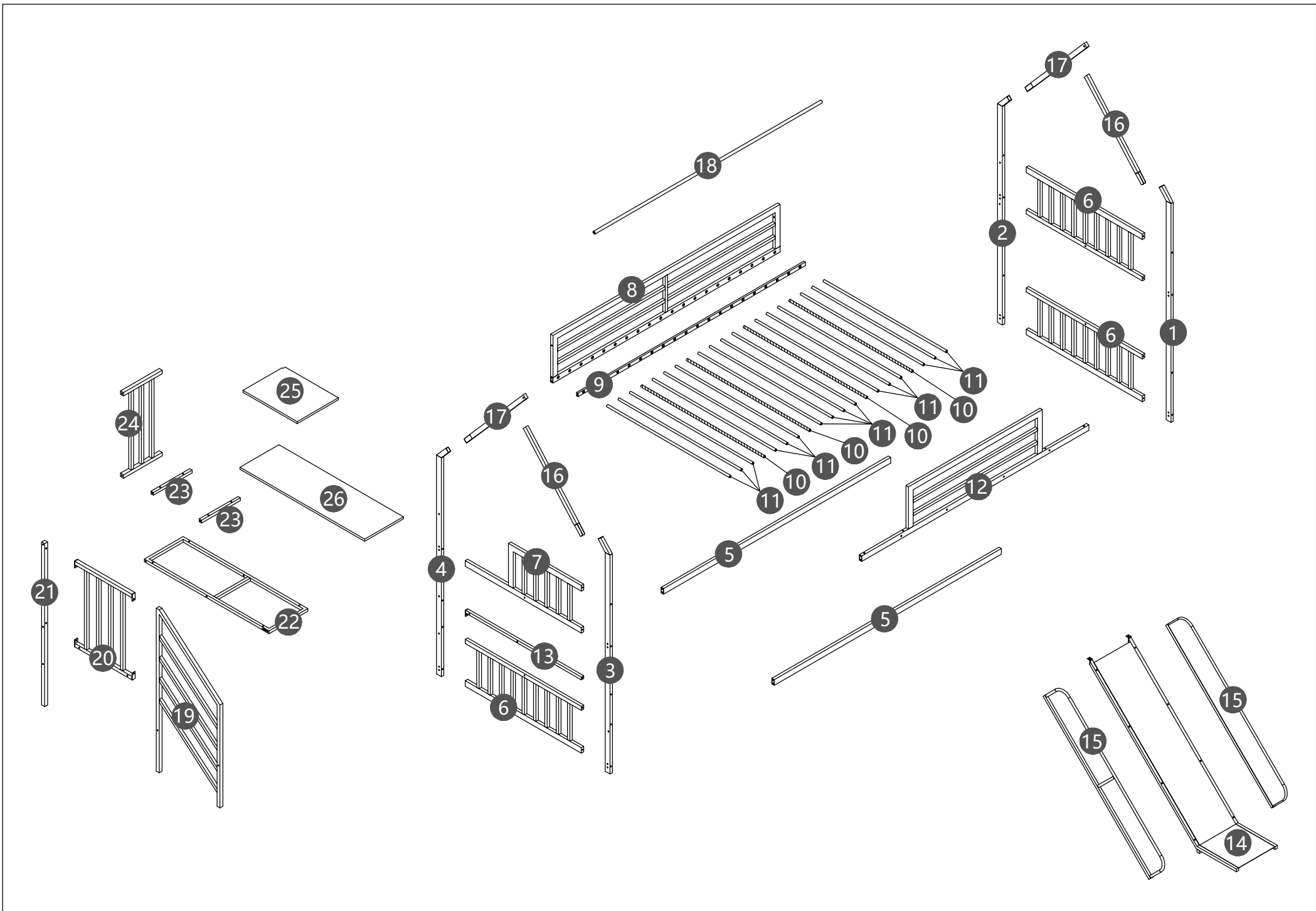



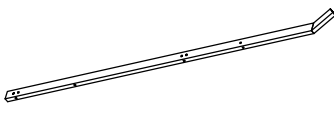
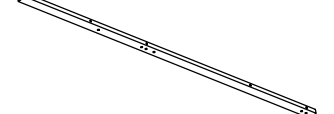
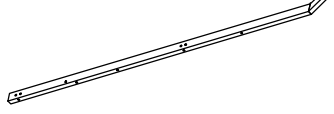
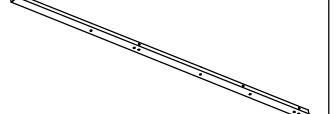
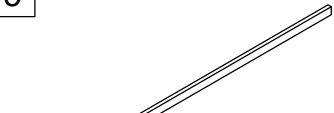
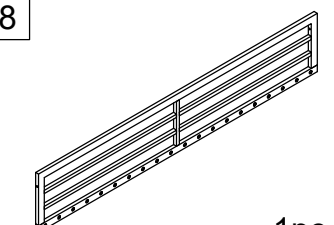
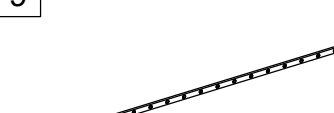
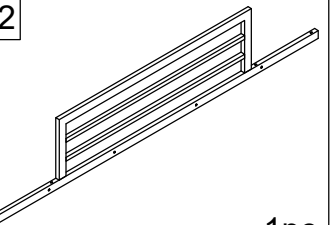
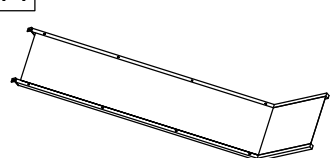
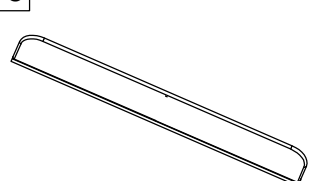
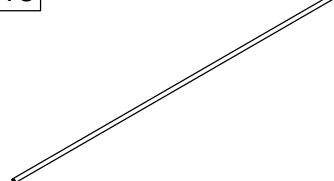



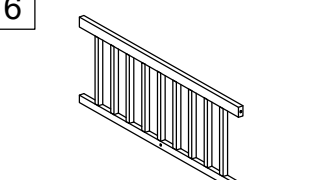
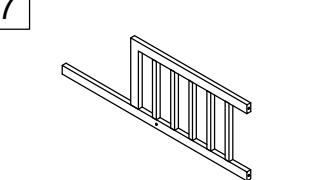
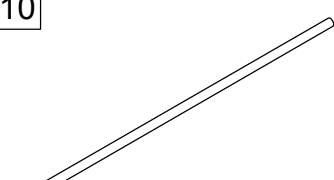
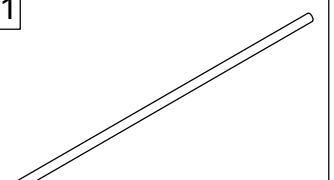
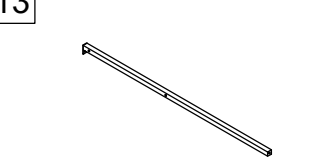
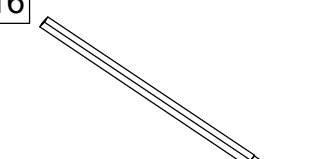
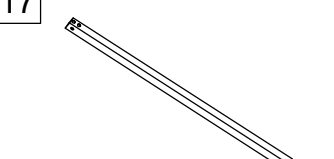
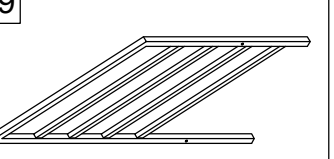
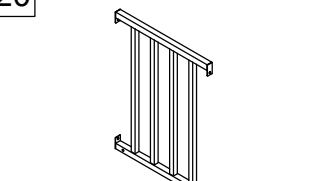
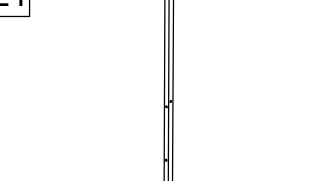
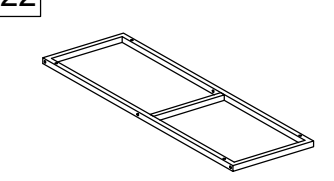
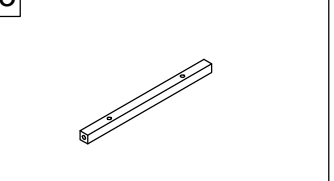
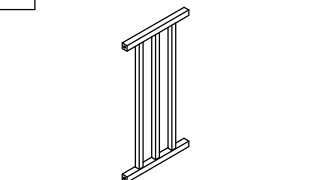
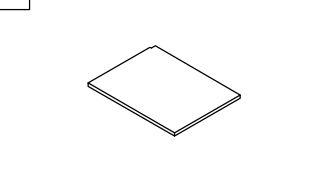
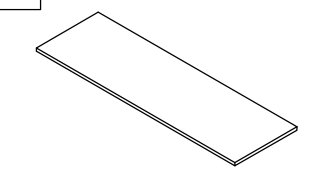





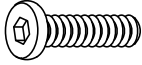
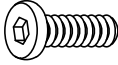

Parts List

<p>1</p>  <p>1pc</p>	<p>2</p>  <p>1pc</p>	<p>3</p>  <p>1pc</p>	<p>4</p>  <p>1pc</p>
<p>5</p>  <p>2pcs</p>	<p>8</p>  <p>1pc</p>	<p>9</p>  <p>1pc</p>	<p>12</p>  <p>1pc</p>
<p>14</p>  <p>1pc</p>	<p>15</p>  <p>2pcs</p>	<p>18</p>  <p>1pc</p>	

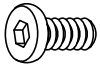
Parts List

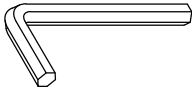
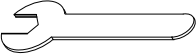
<p>6</p>  <p>3pcs</p>	<p>7</p>  <p>1pc</p>	<p>10</p>  <p>4pcs</p>	<p>11</p>  <p>16pcs</p>
<p>13</p>  <p>1pc</p>	<p>16</p>  <p>2pcs</p>	<p>17</p>  <p>2pcs</p>	<p>19</p>  <p>1pc</p>
<p>20</p>  <p>1pc</p>	<p>21</p>  <p>1pc</p>	<p>22</p>  <p>1pc</p>	<p>23</p>  <p>2pcs</p>
<p>24</p>  <p>1pc</p>	<p>25</p>  <p>1pc</p>	<p>26</p>  <p>1pc</p>	

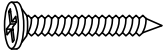
Hardware List

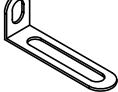

<p>A</p>  <p>M6*65mm 1pc</p>	<p>B</p>  <p>M6*60mm 16pcs</p>	<p>C</p>  <p>M6*55mm 1pc</p>
<p>D</p>  <p>M6*45mm 6pcs</p>	<p>E</p>  <p>M6*40mm 23pcs</p>	<p>F</p>  <p>M6*35mm 6pcs</p>
<p>G</p>  <p>M6*30mm 8pcs</p>	<p>H</p>  <p>M6*25mm 8pcs</p>	<p>I</p>  <p>M6*16mm 8pcs</p>
<p>J</p>  <p>M6*12mm 13pcs</p>	<p>K</p>  <p>M6 4pcs</p>	<p>L</p>  <p>2pcs</p>
<p>M</p>  <p>1pc</p>	<p>N</p>  <p>2pcs</p>	<p>O</p>  <p>2pcs</p>
<p>P</p>  <p>Ø4*14mm 2pcs</p>	<p>Q</p>  <p>M6*50mm 3pcs</p>	<p>R</p>  <p>2pcs</p>

STEP 1:

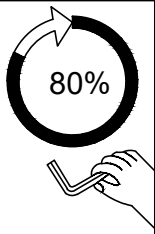
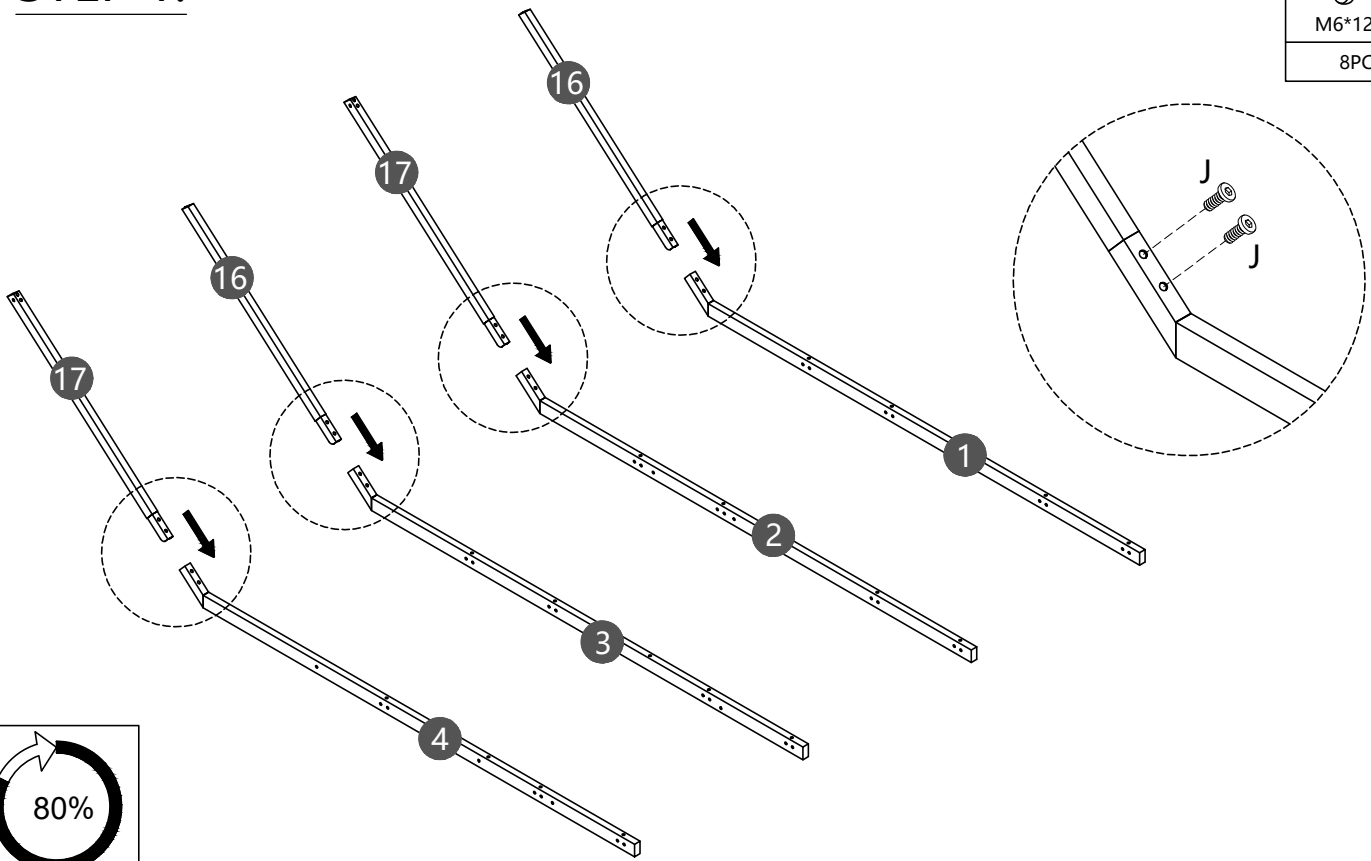
J

M6*12mm
8PCS



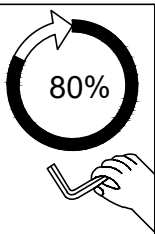
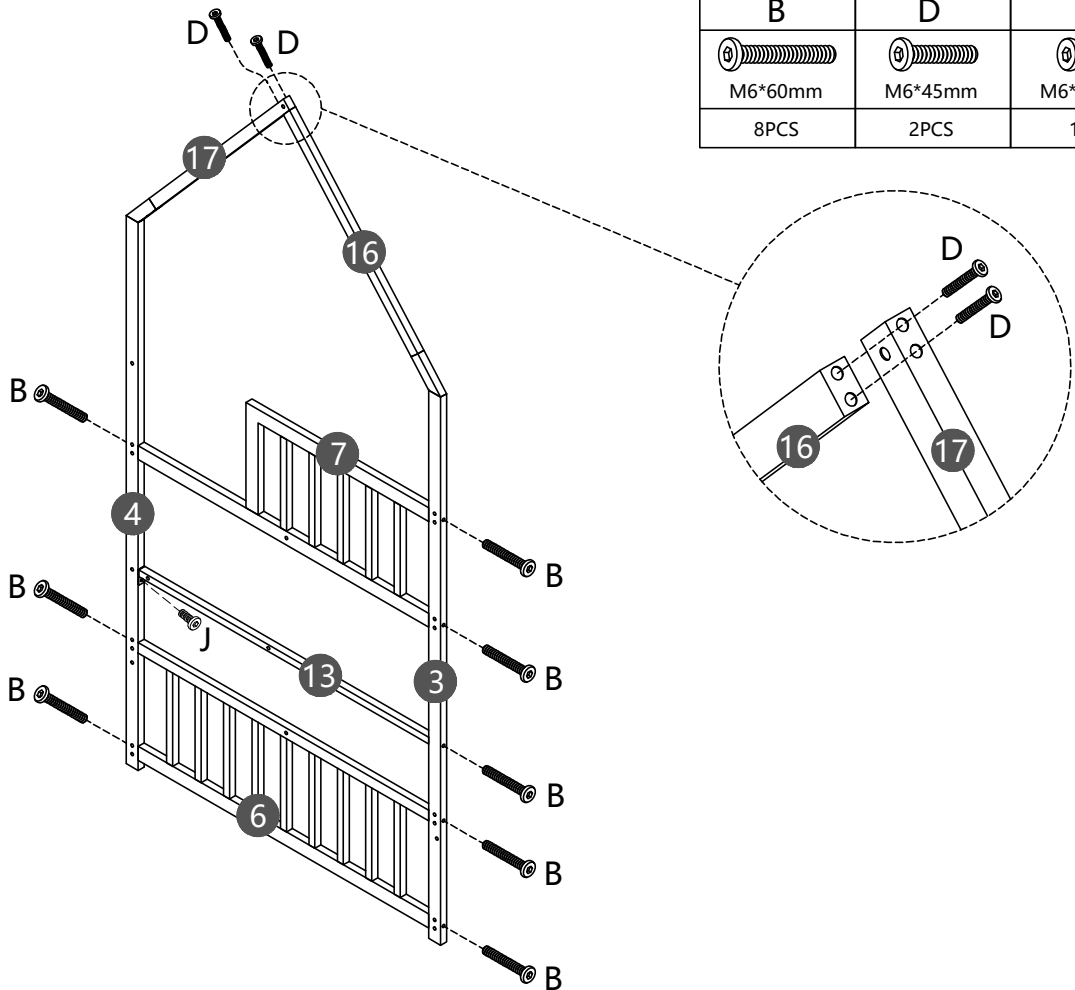

STEP 2:

B	D	J
		
M6*60mm	M6*45mm	M6*12mm
8PCS	2PCS	1PC

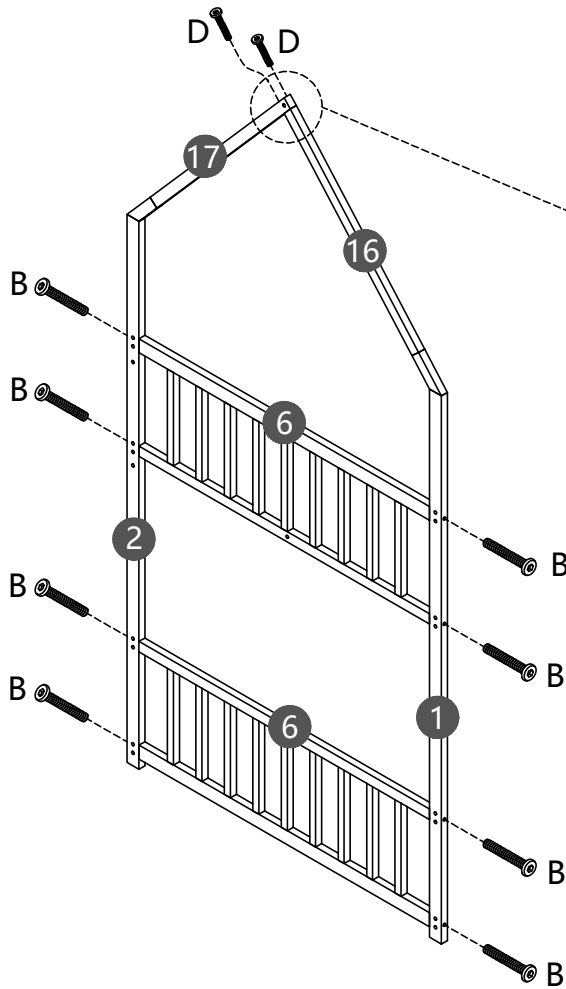

STEP 3:





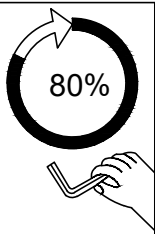

B	D
 M6*60mm	 M6*45mm
8PCS	2PCS

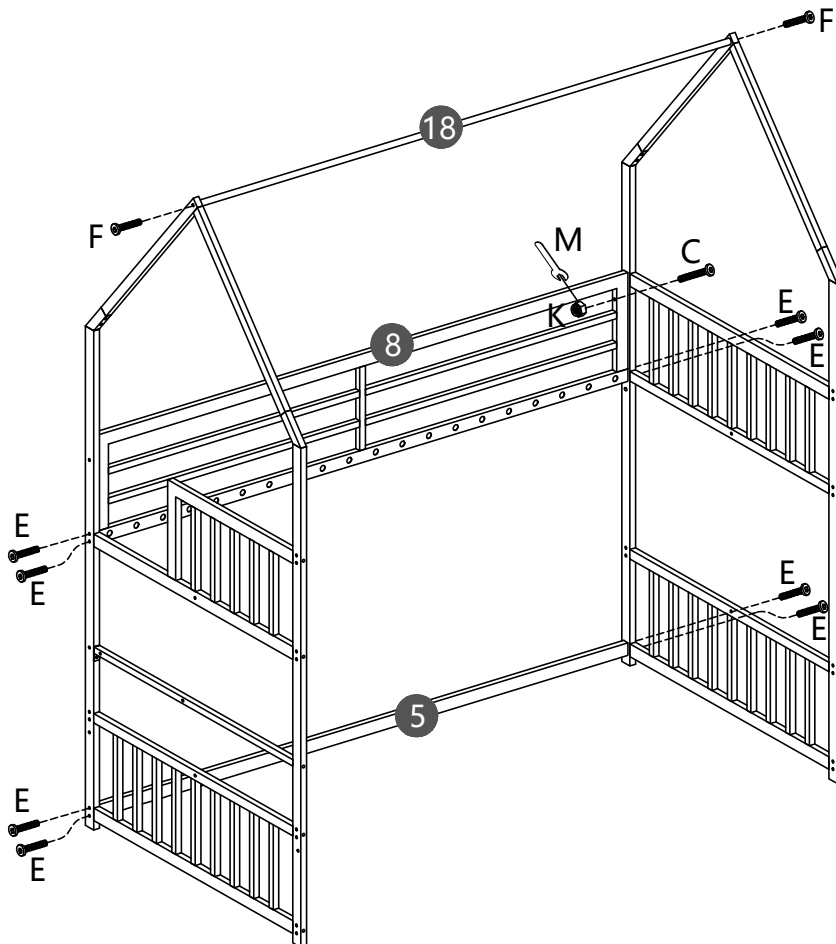

STEP 4:



C  M6*55mm 1PC
E  M6*40mm 8PCS
F  M6*35mm 2PCS
K  1PC

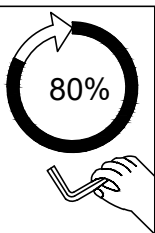

STEP 5:

D

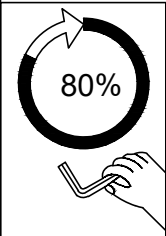
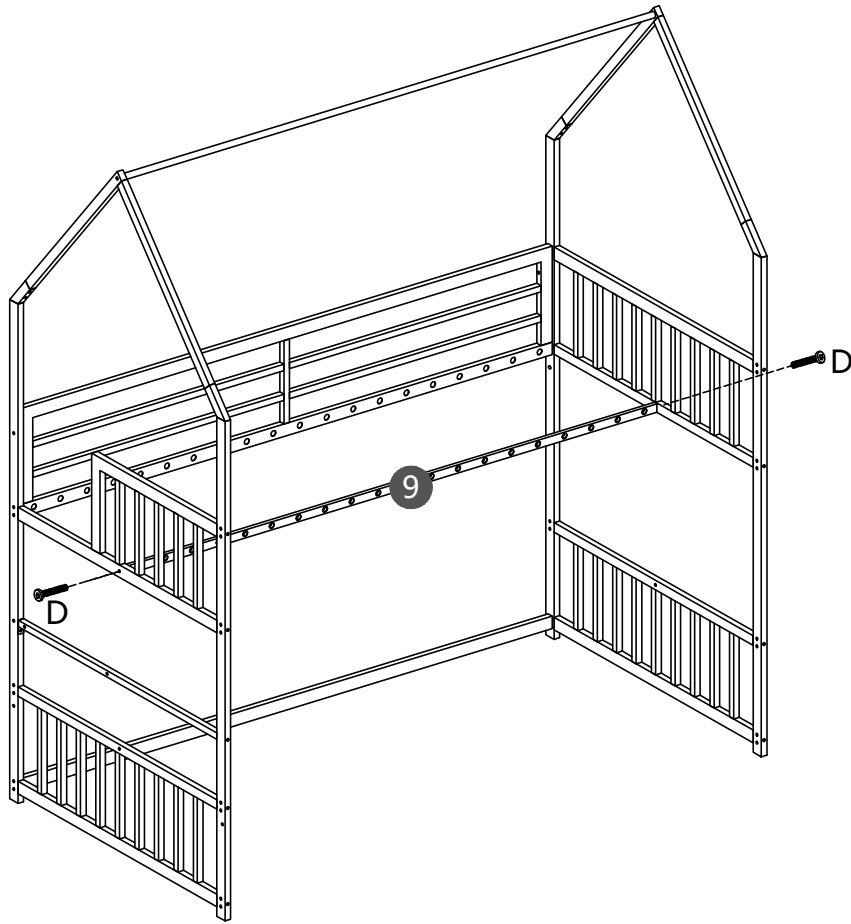
M6*45mm
2PCS





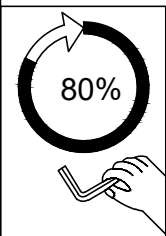
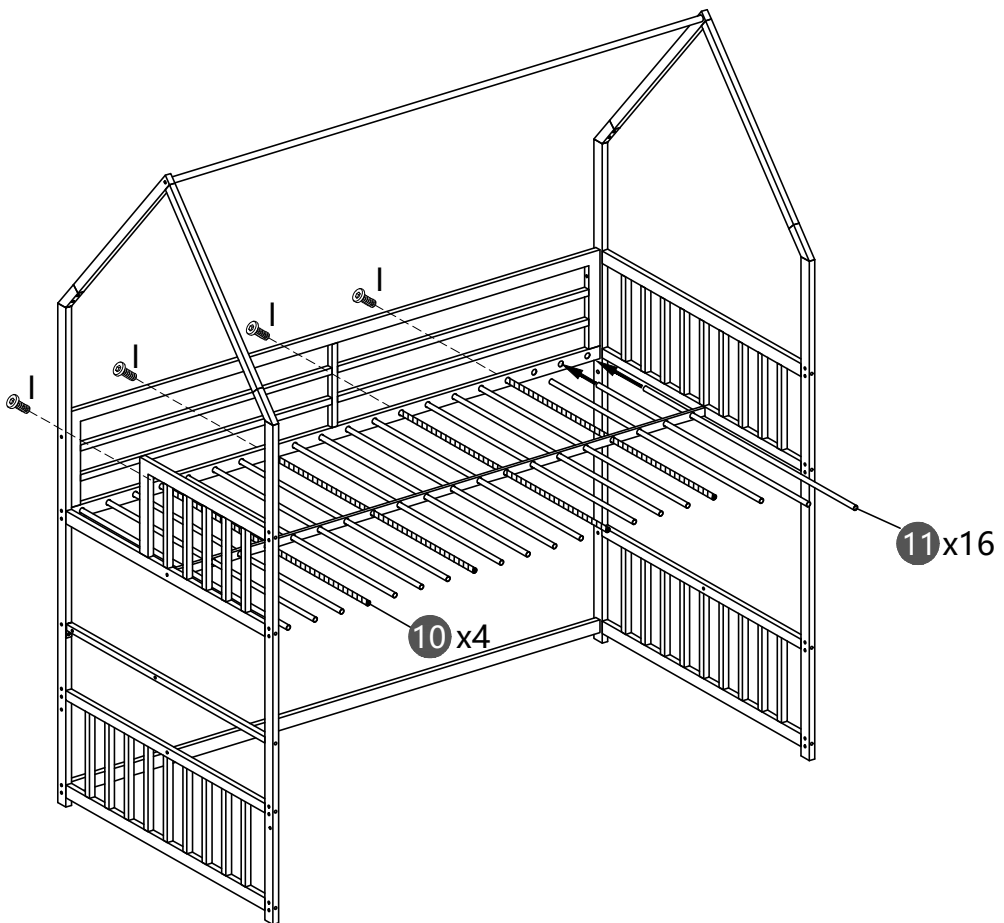

STEP 6:

I

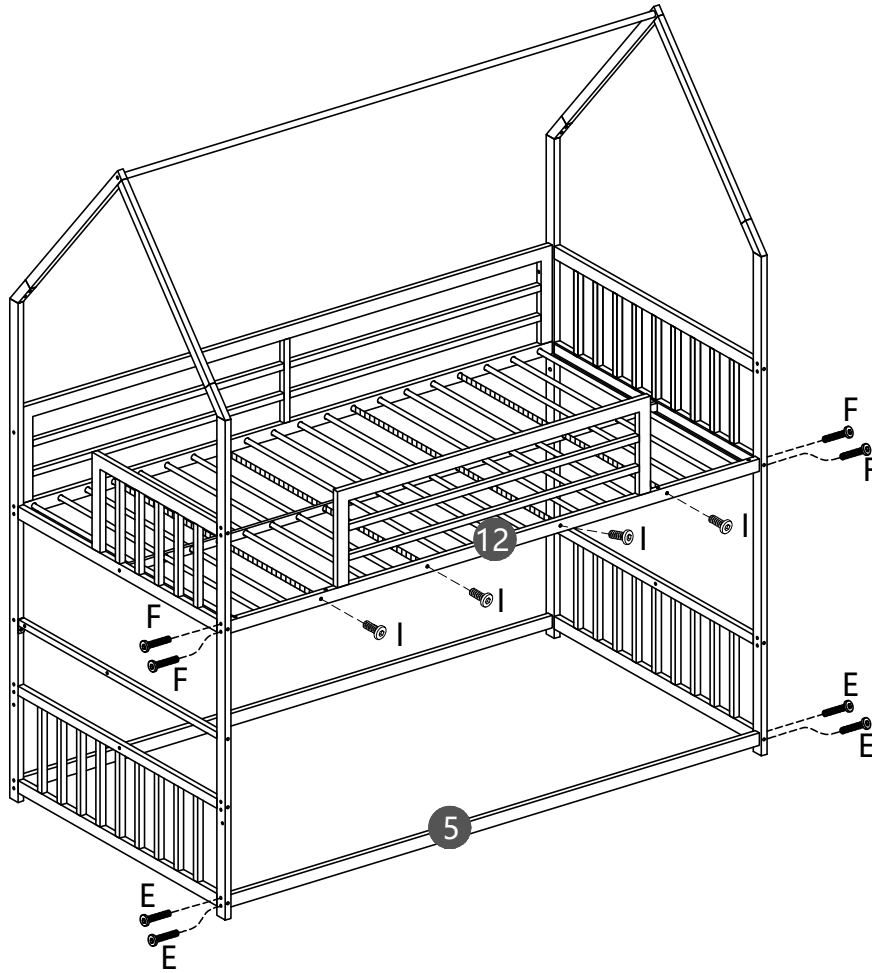
M6*16mm
4PCS





STEP 7:

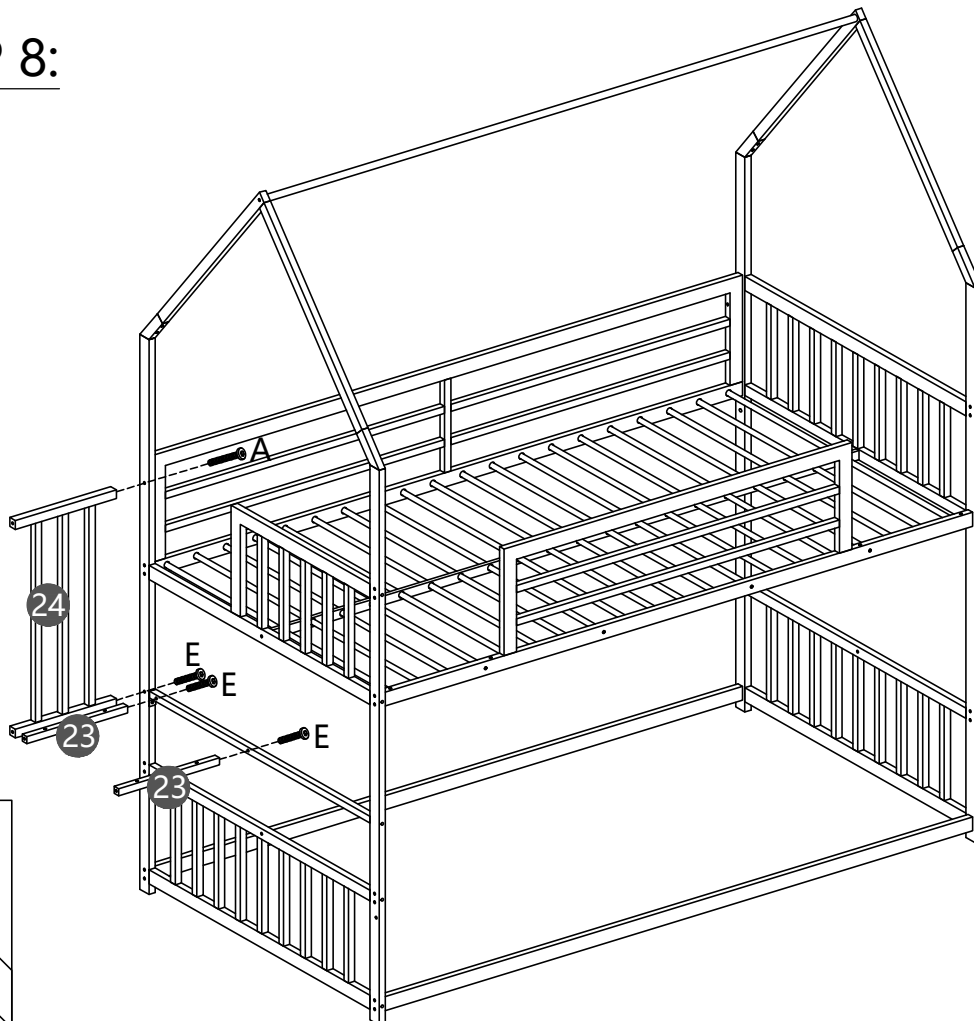

E

M6*40mm
4PCS
F

M6*35mm
4PCS
I

M6*16mm
4PCS

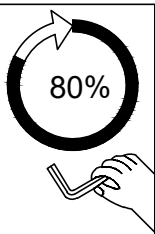
STEP 8:



A	E
	
M6*65mm	M6*40mm
1PC	3PCS



STEP 9:

E

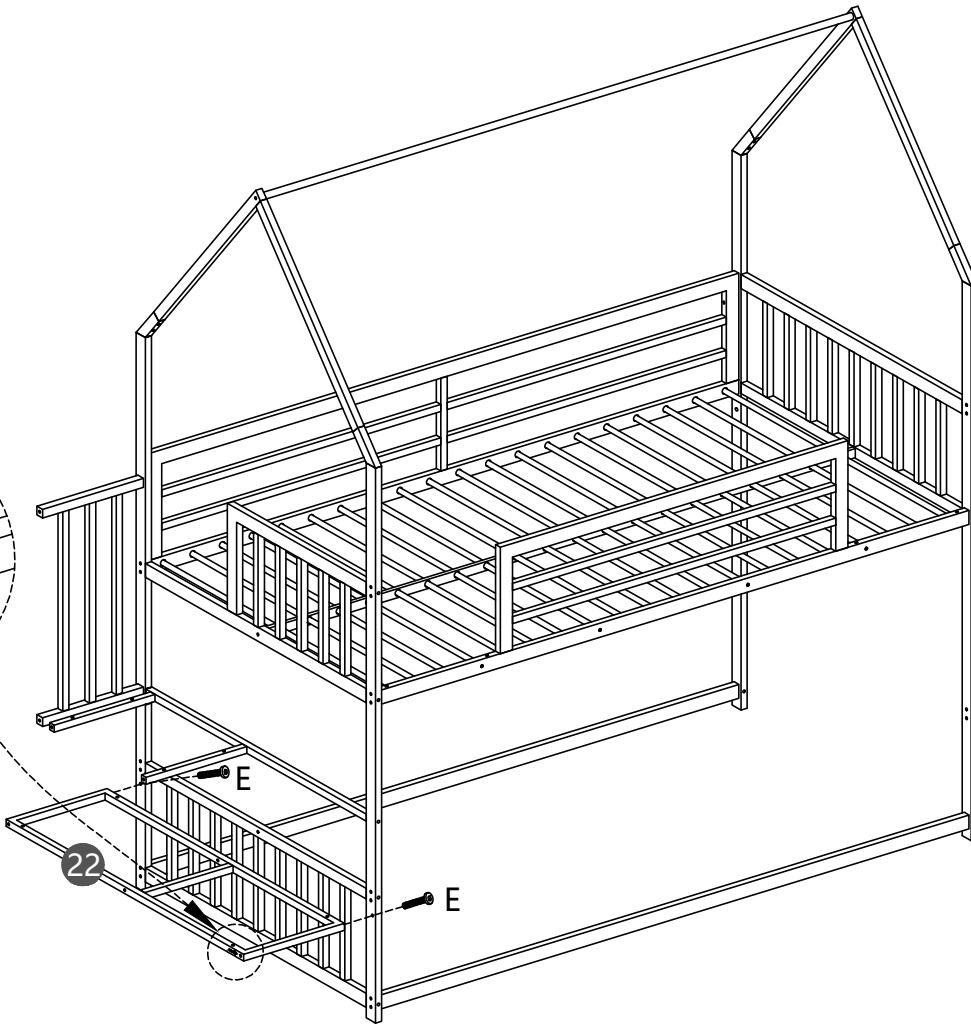
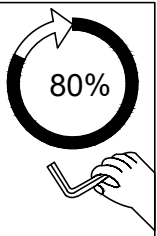
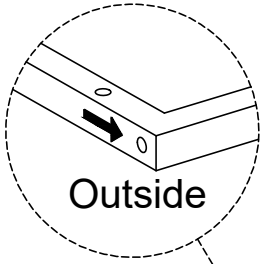
M6*40mm
2PCS





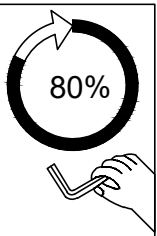
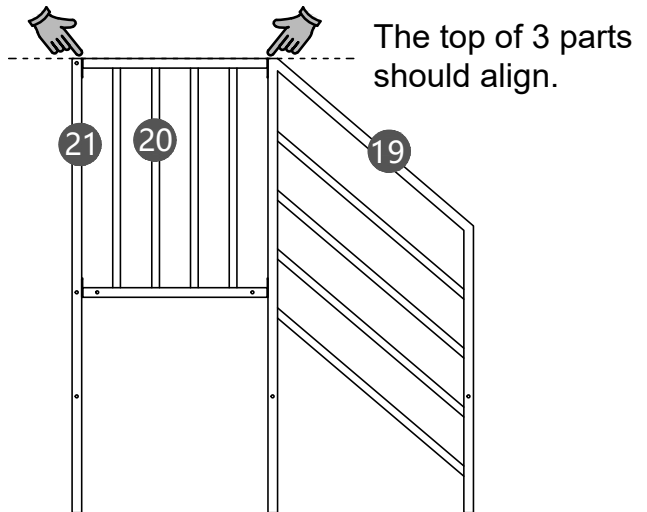
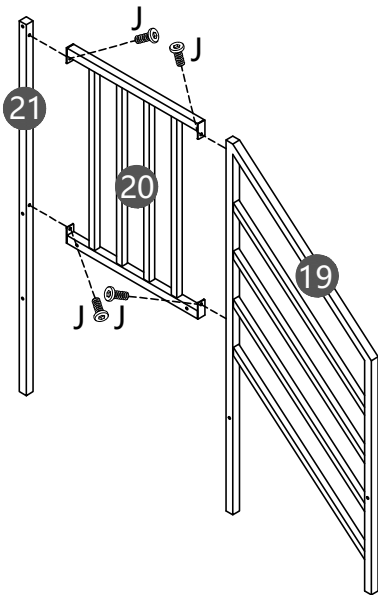

STEP 10:

J

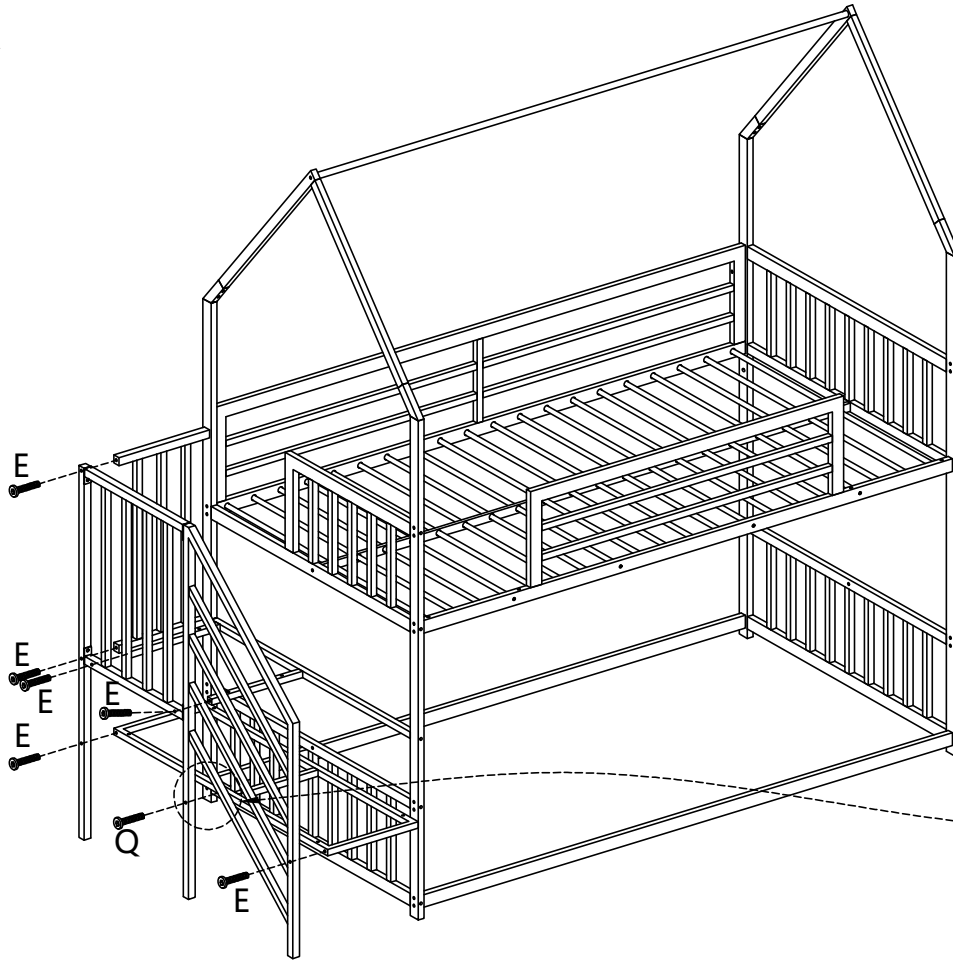
M6*12mm
4PCS



STEP 11:

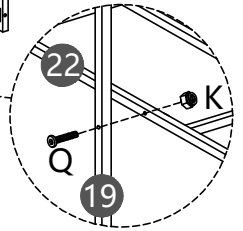

Q
 M6*50mm
1PC
E
 M6*40mm
6PCS
K

1PC

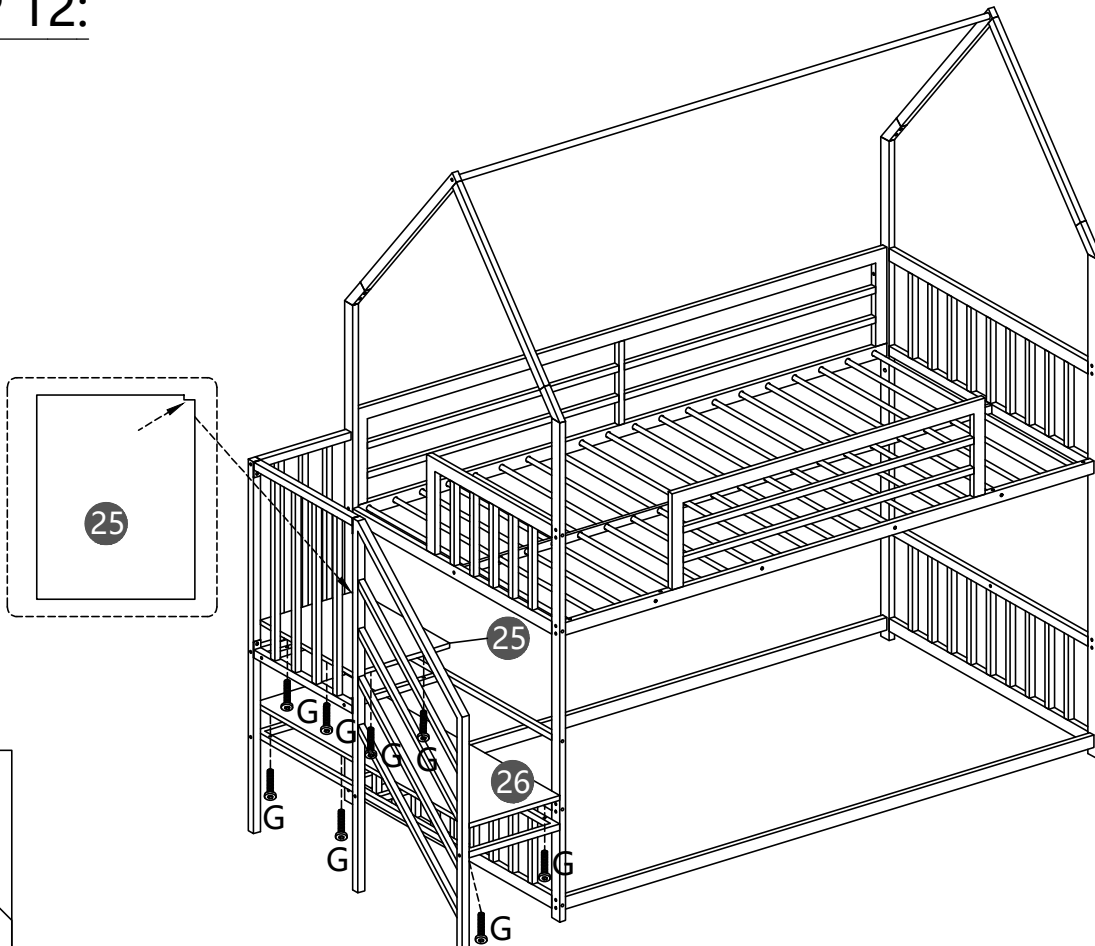

STEP 12:

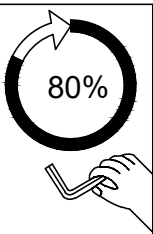

G
 M6*30mm
8PCS



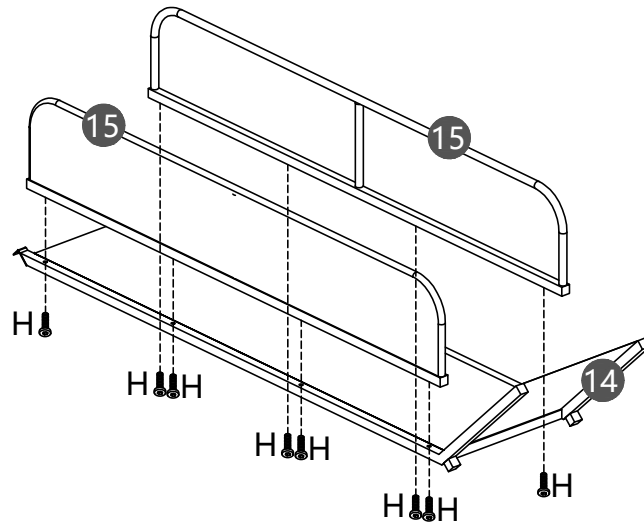

STEP 13:

H
 M6*25mm
8PCS



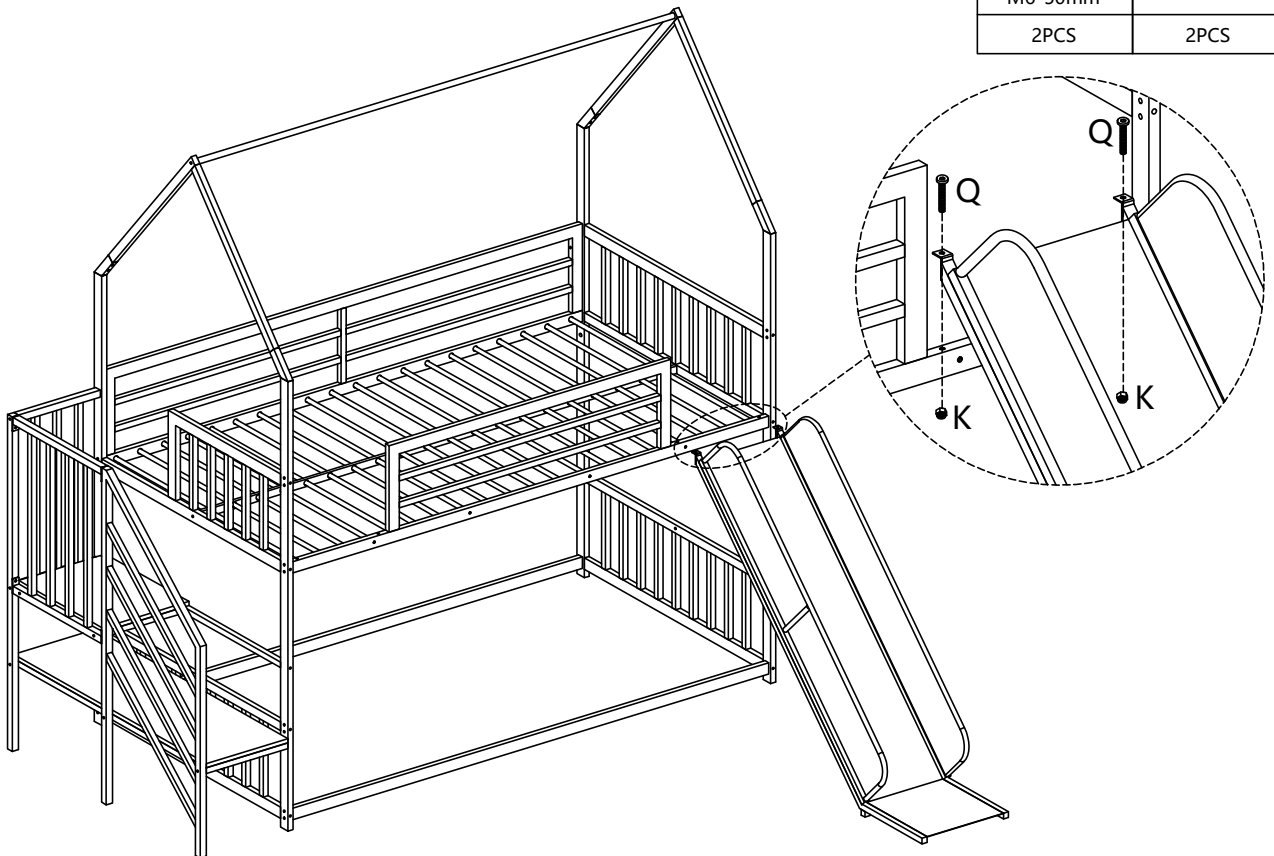

STEP 14:

Q	K
 M6*50mm	
2PCS	2PCS

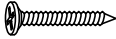

STEP 15:

N	O
	
2PCS	2PCS
R	P
	
2PCS	2PCS

