

ASSEMBLY INSTRUCTIONS

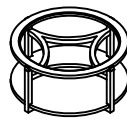

086-911

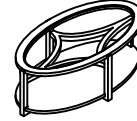

086-912

TOOLS REQUIRED:

Allen Wrench (Provided, Part E)

BEFORE YOU START:

1. Check the hardware against the hardware list to make sure all items are present.
2. Assemble your furniture on a soft, flat surface to avoid scratching the finish.
3. **CAUTION:** Do not over tighten screws, nuts or bolts during assembly.
4. Your furniture may require occasional tightening.

INSTRUCTIONS:

Step 1. Turn the top stretcher upside down on a clean soft surface. Attach the support leg to be aligned with the hole on stretcher. Tighten Bolt (B) with Flat Washer (D)+Lock Washer (C) by Allen Wrench (E) as Figure 1 shown. Repeat the other 2 legs.

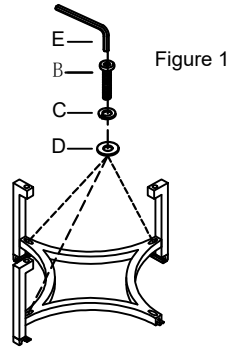

Step 2. Put the bottom shelf to the notch of support legs tightened Bolt (B) with Flat Washer (D)+Lock Washer (C) by Allen Wrench (E) as Figure 2 Shown.

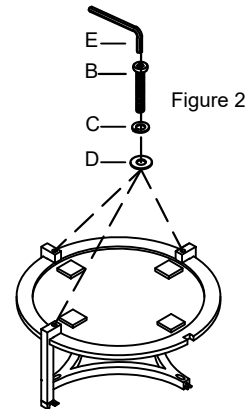

Step 3. Attach the 4th support legs to align with the holes on both top stretcher and bottom shelf, tighten Bolt (B) with Flat Washer (D)+Lock Washer (C) by Allen Wrench (E) as Figure 3 shown.

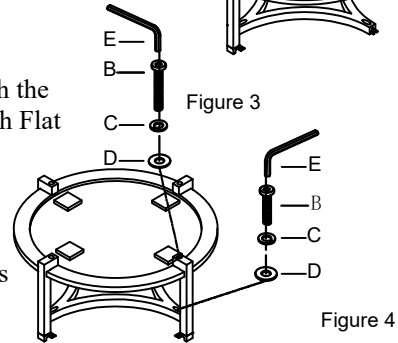

Step 4. Place the table to top round frame to make sure holes on metal cap is aligned with holes on top round frame. Tighten Bolt (B) with with Flat Washer (D)+Lock Washer (C) by Allen Wrench (E) as Figure 4 shown.

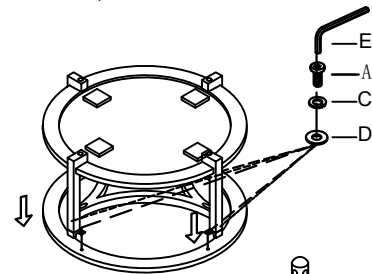

Step 5. Tighten all bolts before setting table back upright as Figure 5 shown.
Step 6. Place the glass on top of the top frame as Figure 6 shown.

Figure 5

Figure 6

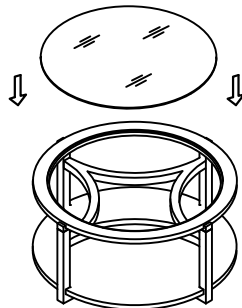

HARDWARE LIST			
A		Bolt (Ø1/4"x3/4")	8pcs
B		Long Bolt (Ø1/4"x1-3/4")	8pcs
C		Lock Washer (Ø1/4")	16pcs
D		Flat Washer (Ø1/4")	16pcs
E		Allen Wrench (100*50*4mm)	1pc
F		Screw (Φ8x5/8")	16pcs
G		Caster (Φ50*H64mm)	4pcs

