

RBMU36R



Product family	Refrigerator
Installation	Built-in
Category	Bottom mount
Built-in niche	>200
No-frost system	Total
Cooling type	No-frost
Defrost	Automatic
Hinge	Door-to-door
Kitchen panel	Not supplied
Hinge position	Right
EAN code	8017709332716



Aesthetic

Aesthetics	Universal	Drawers profile color	Silver
Material	Steel	Glass shelf profile color	Silver
Logo color	Silver	Display	TFT
Side material	Steel	Display position	Internal
Logo	Silkscreened	Water filter	Yes
Door shelf profile color	Silver	Available colors	Steel

Refrigerator compartment features



Number of compartments	2	Crisper cover	Yes
Compartment types	Low temperature compartment, Fruit and vegetable compartment	Type of crisper cover	Glass
No. of adjustable shelves	3	Low temperature compartment	Yes
Number of fruit and vegetables drawers	1	Refrigerator lighting	Yes
Type of adjustable shelves	Glass	Refrigerator lighting	LED
Crisper drawer type	Sliding crisper		

Refrigerator Inner Door

Number of adjustable door shelves	3	Adjustable door bins with wire support	Yes
-----------------------------------	---	--	-----

Other Refrigerator features



MultiFlow Yes

Freezer features

Number of drawers	1	Freezer lighting	Yes
No. of lights	2	Freezer lighting	LED

Other Freezer features

Ice maker	Automatic	Ice-tray shelf	Yes
-----------	-----------	----------------	-----

Other technical features



Display functions	Holiday, Fast-freezing, Fast-cooling, Temperature alarm, Showroom mode, Sabbath
MultiZone	Yes
Water network connection	Yes
Power-on light	Yes
Temperature alarm	Yes
Door open alarm	Yes
Temperature setting type	Electronic
No. of compressors	2
Refrigerant gas type	R600a
Compressor type	Inverter
Refrigerant quantity	3.8 oz
Foam agent	HFO

Performance / Energy Label

Annual energy consumption	580 kWh/year	Refrigerator compartment	15.01 cu. ft.
Total volume	19.63 cu. ft.	Total volume	20.52 cu. ft.
Freezer volume	4.63 cu. ft.		

Electrical Connection

Current	3,5 A	Power cord length	78 3/4 "
Voltage (V)	115 V	Plug	(B) NEMA 5-15P
Frequency (Hz)	60 Hz		

Logistic Information

Width	35 7/8 "	Height	83 7/16 "
Built-in niche width	36 "	Built-in niche height	84 "
Depth without handle	24 "	Width with doors open at 90°	42 1/8 "
Built-in niche depth	24 "	Depth with door open at 90°	58 5/8 "

Also available

Installation kit code RSFZLK

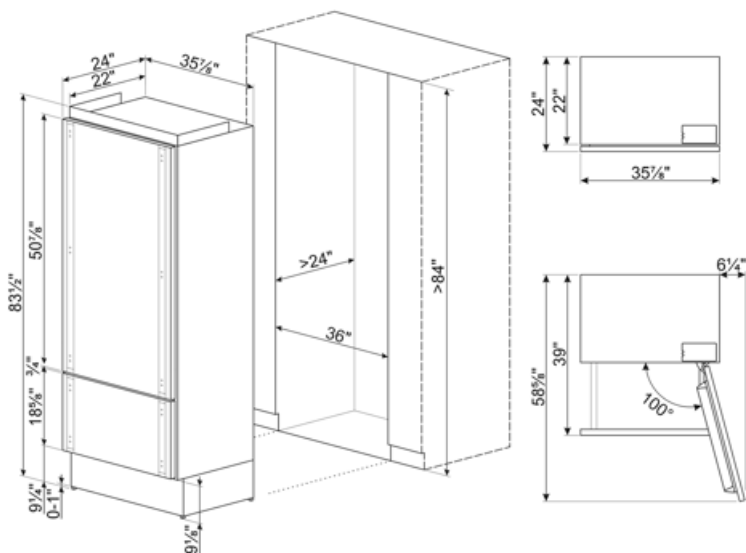







Compatible Accessories

RSFZLK



Symbols glossary

- | | | | |
|--|---|---|---|
|  | The automatic defrost system works by automatically defrosting at regular intervals eliminating the need to defrost altogether. |  | Fast freezing: The fast freezing function brings the temperature of the compartment down when activated a few hours prior to usage. |
|  | Power saving mode: The power saving mode allows you to disable the refrigerator and keep the freezer working. |  | LED interior lighting: is a more energy efficient and long lasting way of illuminating the interior of the appliance. |
|  | Inverter technology: The evolution of Smeg's driers towards more intelligent and environmentally sustainable models has led to the choice of using Inverter technology with heat pumps, which reduces significantly energy consumption. |  | Air plus: keeps food fresher for longer. |
|  | Sabbath: This function allows you to cook food during the Sabbath, the Holiday of rest in the Jewish religion, respecting the precepts. | | |