

DINING CHAIR ASSEMBLY INSTRUCTIONS

PARTS PACKING CONFIGURATIONS

A. CHAIR BACK (1 PC)

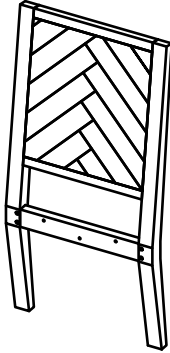



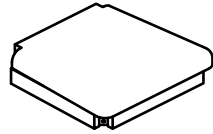



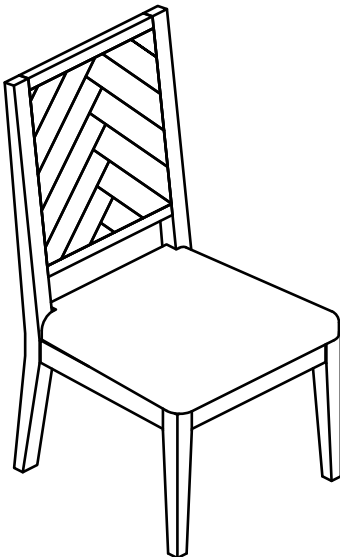
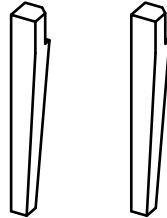

B. CHAIR SEAT (1 PC)



C. FRONT LEG (2 PCS)



HARDWARE LIST:

No.	Description	Photo	Quantity
1	ALLEN BOLT (M6X40)		3 PCS
2	ALLEN BOLT (M6X30)		4 PCS
3	HEX NUT (M8)		4 PCS
4	FLAT WASHER (M6)		7 PCS
5	SPRING WASHER (M6)		7 PCS
6	FLAT WASHER (M8)		4 PCS
7	SPRING WASHER (M8)		4 PCS
8	ALLEN KEY		1 PC
9	SPANNER		1 PC

DINING CHAIR ASSEMBLY INSTRUCTIONS

STEP 1:

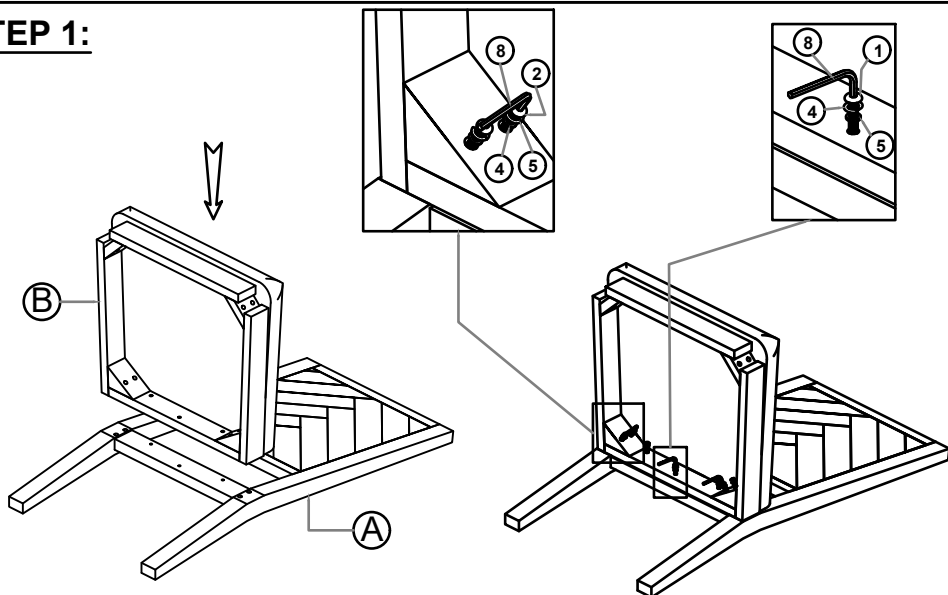

STEP 2:

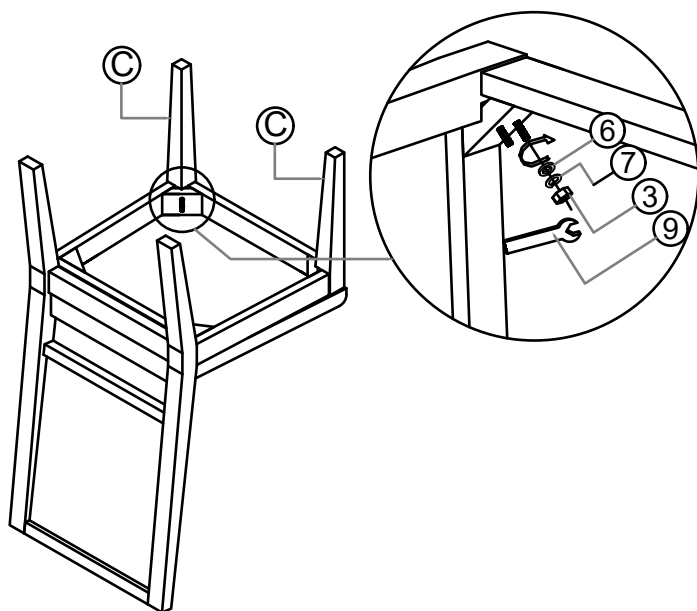

DINING CHAIR ASSEMBLY INSTRUCTIONS

E

DINING CHAIR FULLY ASSEMBLED :

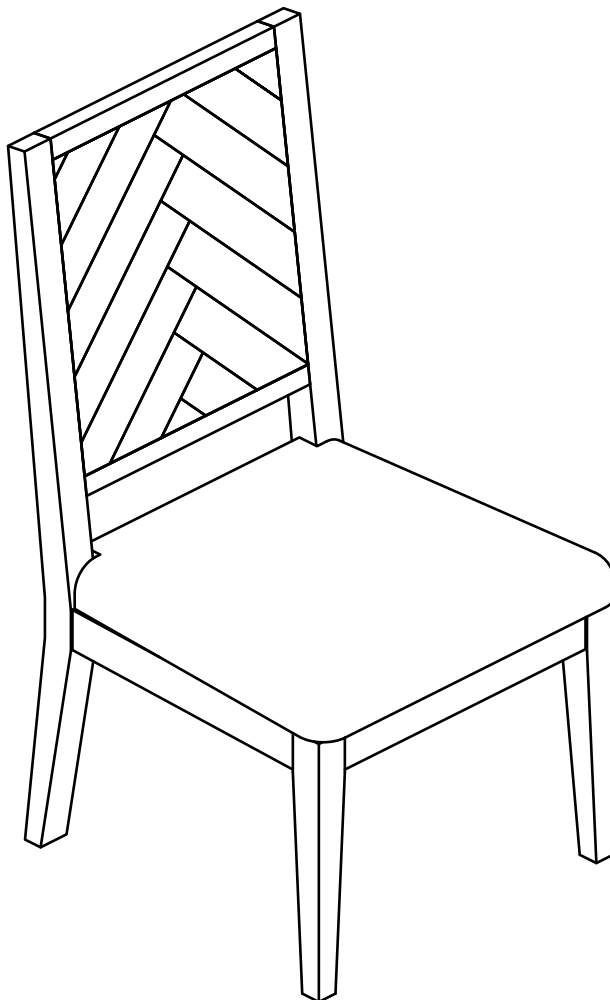

IF YOUR CHAIR IS NOT LEVEL AFTER ASSEMBLY,
MOVE CHAIR TO A FLAT, LEVEL AREA. LOOSEN,
BUT DO NOT COMPLETELY UNDO, ALL BOLTS.
ONCE CHAIR ASSEMBLY IS LOOSE, LEVEL CHAIR
ON FLAT SURFACE. ONCE LEVEL,
RETIGHTEN ALL ASSEMBLY BOLTS.