

**EN\_Tips:** Please do not use in strong winds to avoid damage. When not in use, please remove the umbrella and store it to keep dry.

**FR\_Conseils :** Évitez les dommages, veuillez ne pas utiliser par vent fort. Lorsqu'il n'est pas utilisé, veuillez retirer le parasol à temps et conservez-le au sec.

**ES\_Consejos:** evitar daños; por favor, no use cuando hace viento. Cuando no esté en uso: por favor retire el paraguas a tiempo, y guárdelo para mantenerlo seco.

**PT\_Dicas:** Por favor não utilizar em ventos fortes para evitar danos. Quando não estiver a ser utilizado, por favor retire o guarda-chuva e guarde-o para se manter seco.

**DE\_Tipps:** Um Schäden vorzubeugen, nutzen Sie das Produkt bitte nicht bei starkem Wind. Wenn nicht in Benutzung, klappen Sie den Schirm bitte zeitnah ein und lagern Sie ihn an einem trockenen Ort.

**IT\_Suggerimenti:** evitare danni, si prega di non utilizzare quando fuori C'è vento. Quando non in uso, si prega di rimuovere l'ombrello tempestivamente e conservare per tenerlo asciutto.

**EN\_IMPORTANT, RETAIN FOR FUTURE REFERENCE: READ CAREFULLY.**

**FR\_IMPORTANT: A LIRE ATTENTIVEMENT ET À CONSERVER POUR CONSULTATION ULTÉRIEURE.**

**ES\_IMPORTANTE, LEA Y GUARDE PARA FUTURAS REFERENCIAS.**

**PT\_IMPORTANTE, RETER PARA REFERÊNCIA FUTURA: LEIA ATENTAMENTE.**

**DE\_WICHTIG! SORGFÄLTIG LESEN UND FÜR SPÄTER NACHSCHLAGEN AUFBEWAHREN.**

**IT\_IMPORTANTE! CONSERVARE IL PRESENTE MANUALE PER FUTURO RIFERIMENTO E LEGGERLO ATTENTAMENTE.**

**C** x 1

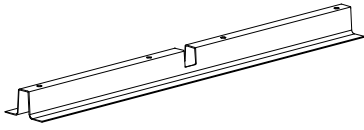

**D** x 1

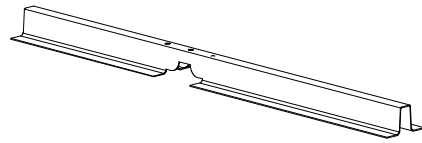

**E** x 1

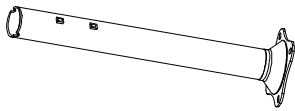

**F** x 1

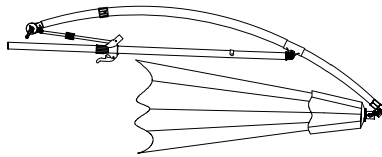

**G** x 1

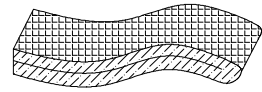

**H** x 2

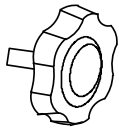

**I** x 4

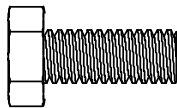

**J** x 4

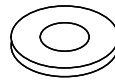

**K** x 1

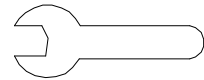

**A** x 4

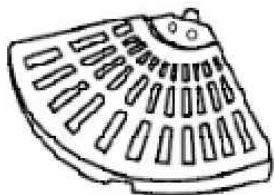

**B** x 4



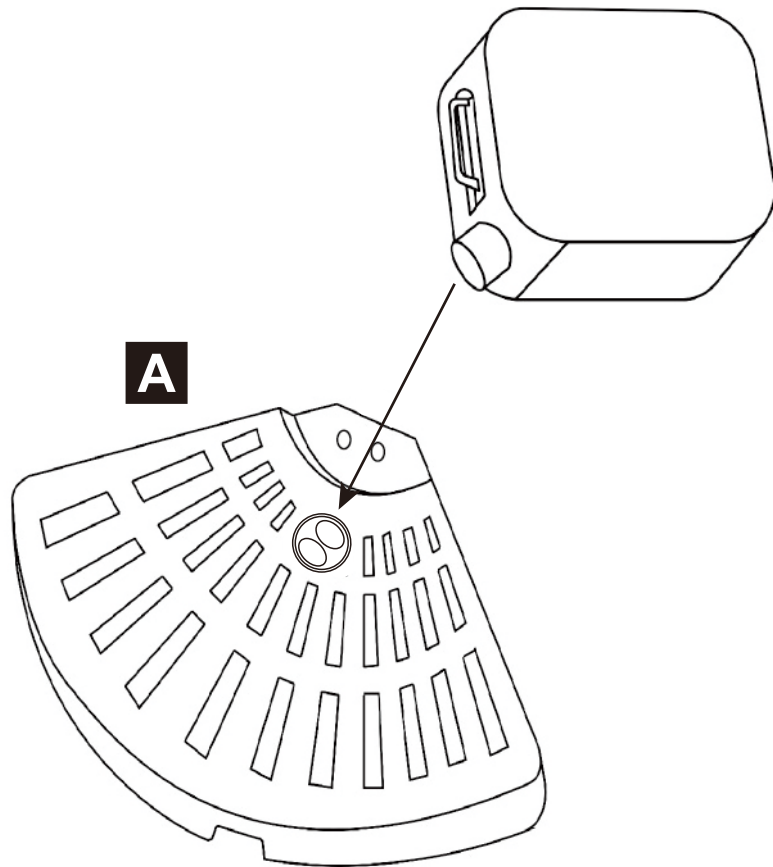
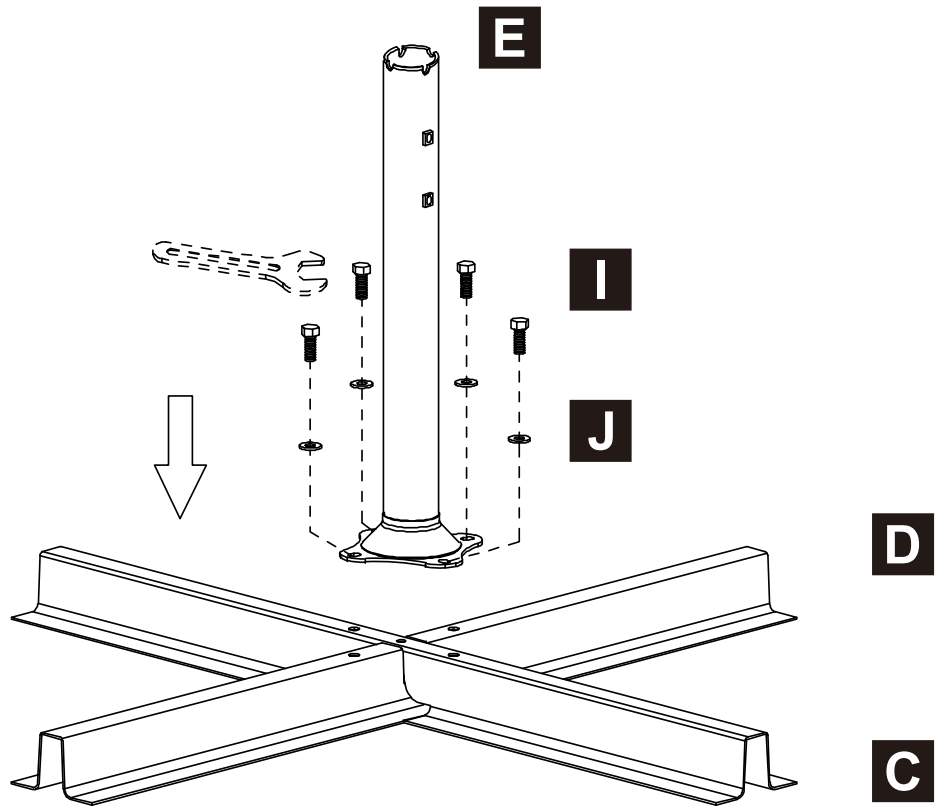

03

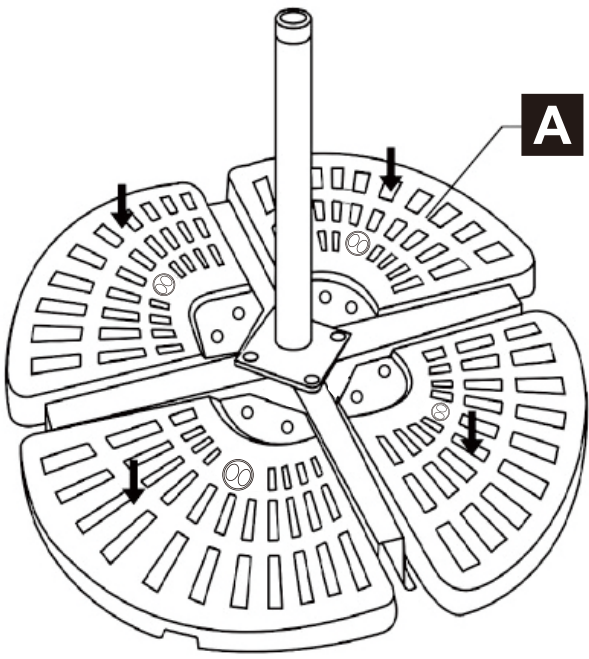

04

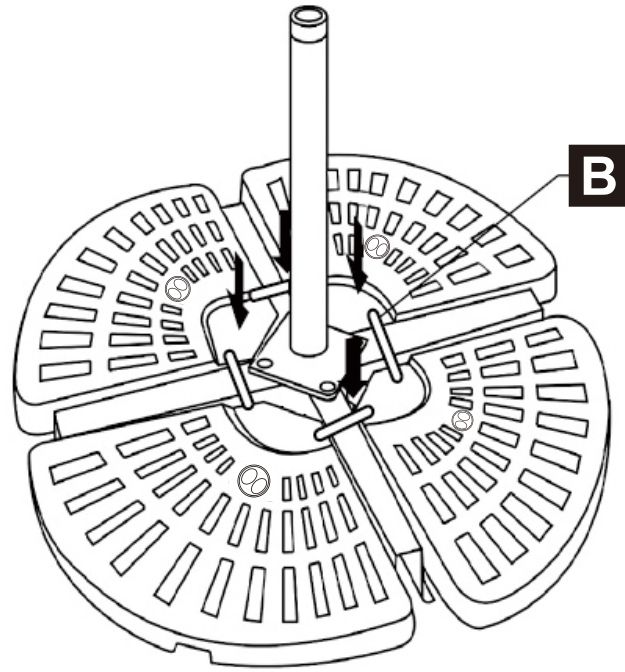

05

