

Installation & Assembly

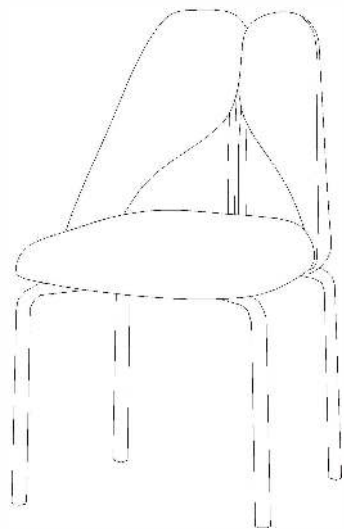

Notice:

1. Follow the installation instructions. Please confirm all accessories are present before installation.
2. Do not fully tighten the screws during initial assembly. Fully tighten screws only once all pieces which are correctly assembled.
3. If you encounter any problems during installation, please contact our customer service.

Reference Image Qty			Reference Image Qty		
(A)		X1	(1)	 6×35mm	X2
(B)		X1	(2)		X7
			(3)		X1
			(4)	 6×25mm	X4

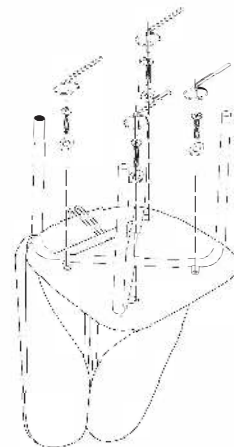
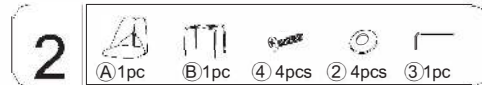
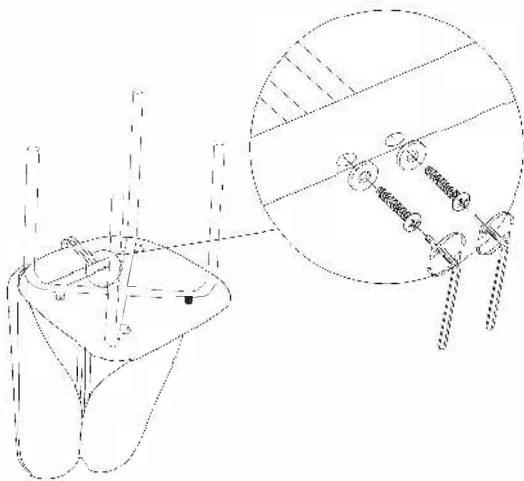
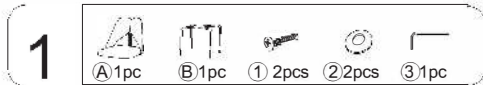

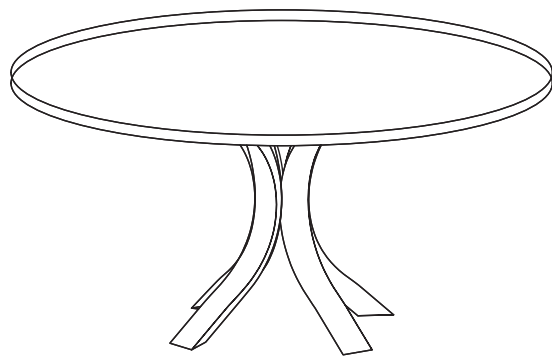

Dining Table

Notice:

1. Follow the installation instructions. Please confirm all accessories are preset before installation.
2. Do not fully tighten the screws during initial assembly. Fully tighten screws only once all pieces which are correctly assembled.
3. If you encounter any problems during installation, please contact our customer service.
4. Please unbox the item from the side with an open-label and put a carpet on the floor to avoid scratching it.



Recommended installation



Put a carpet on the floor before unpacking



Estimate installation time: 30 minutes

Item no.	Reference Image	Qty	Item no.	Reference Image	Qty
Ⓐ		x1	①		x4
Ⓑ		x1	②		x4
Ⓒ		x1			

1

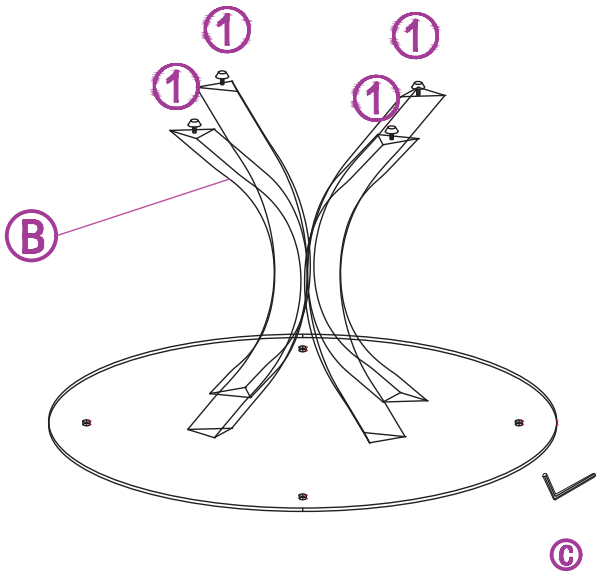

2

