

Headrest Module Cloud Couch

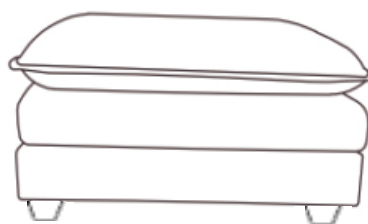

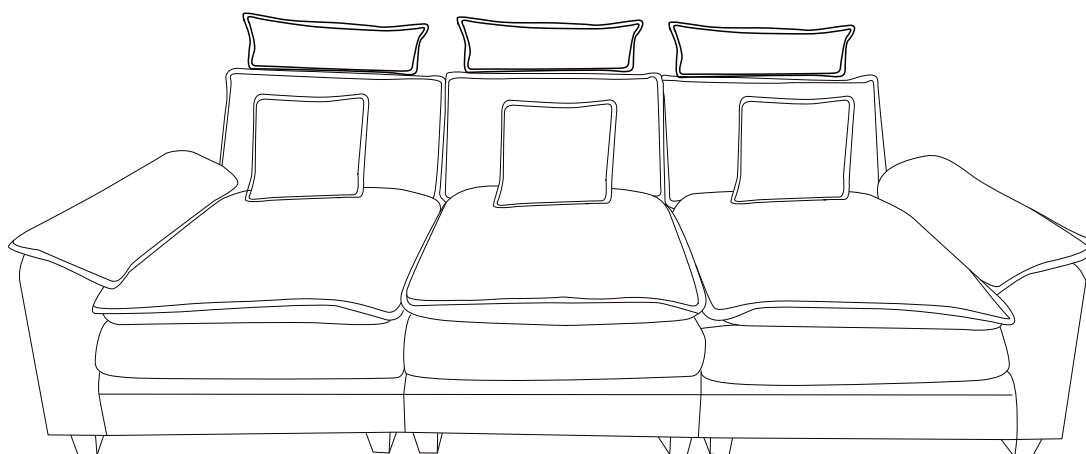

ASSEMBLY INSTRUCTIONS





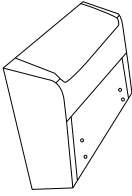
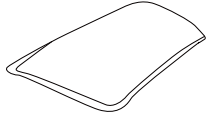



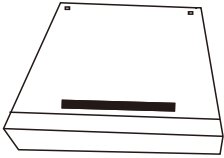

Two person assemble the sofa will be more easier.

Parts List

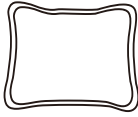
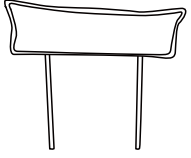
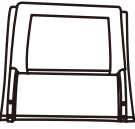





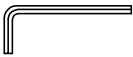

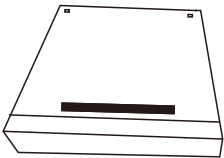

BOX A

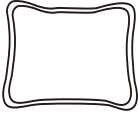
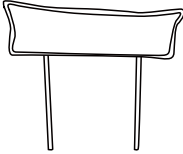
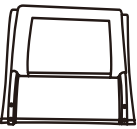
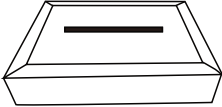
<p>H</p> 	<p>L</p> 	<p>①</p>  <p>M8x60mm</p>	<p>②</p> 	<p>⑥</p> 
2PCS	2PCS	8PCS	8PCS	1PC

BOX B

<p>A</p> 	<p>B</p> 	<p>C</p> 	<p>D</p> 	<p>E</p> 
2PCS	2PCS	2PCS	2PCS	2PCS
<p>F</p> 	<p>G</p> 	<p>①</p>  <p>M8x60mm</p>	<p>②</p> 	<p>③</p> 
2PCS	8PCS	8PCS	8PCS	8PCS
<p>④</p>  <p>M6x16mm</p>	<p>⑤</p> 	<p>⑥</p> 		
4PCS	4PCS	1PC		

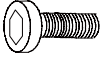
BOX C

<p>A</p> 	<p>B</p> 	<p>C</p> 	<p>D</p> 	<p>E</p> 
<p>1PC</p>	<p>1PC</p>	<p>1PC</p>	<p>1PC</p>	<p>1PC</p>
<p>F</p> 	<p>J</p> 	<p>K</p> 	<p>G</p> 	<p>①</p>  M8x60mm
<p>1PC</p>	<p>1PC</p>	<p>1PC</p>	<p>8PCS</p>	<p>4PCS</p>
<p>②</p> 	<p>③</p> 	<p>④</p>  M6x16mm	<p>⑤</p> 	<p>⑥</p> 
<p>4PCS</p>	<p>8PCS</p>	<p>2PCS</p>	<p>2PCS</p>	<p>1PC</p>

Assembly Instruction

The cushions is packaged by vacuum compression.
After cutting the package, it rebounds quickly within 4 hours. If the fabric has wrinkles it will basically disappear after standing for 72 hours.

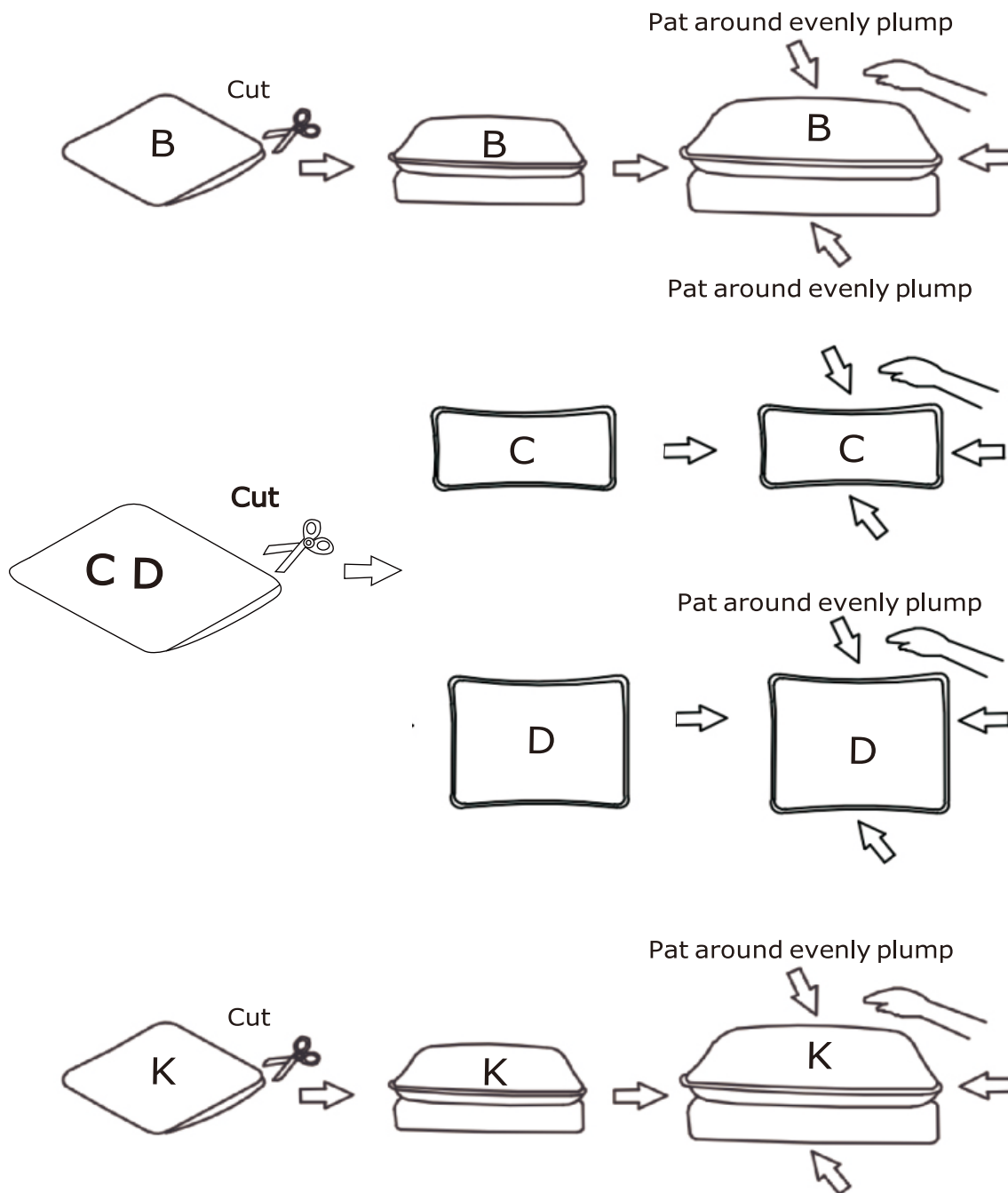

Assembly Instruction

Step 1

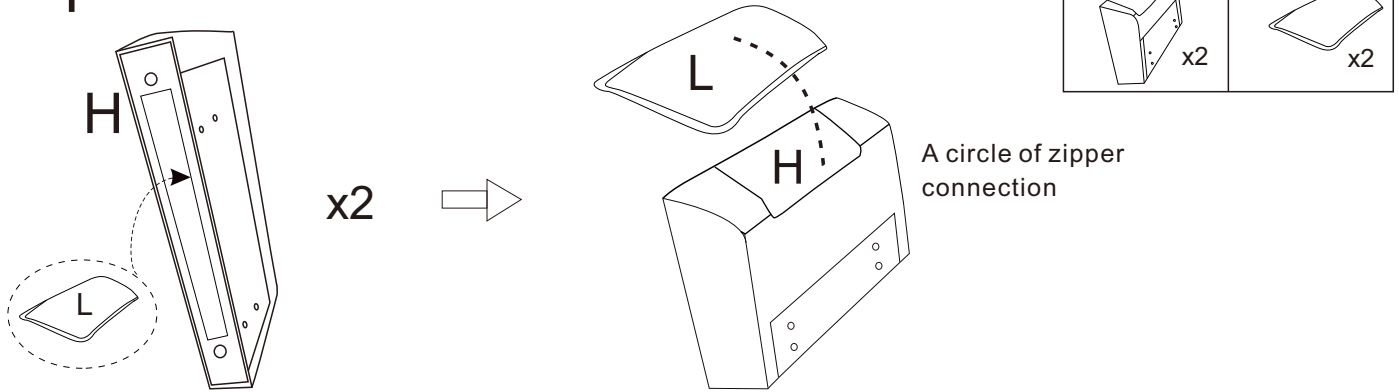

Step 2

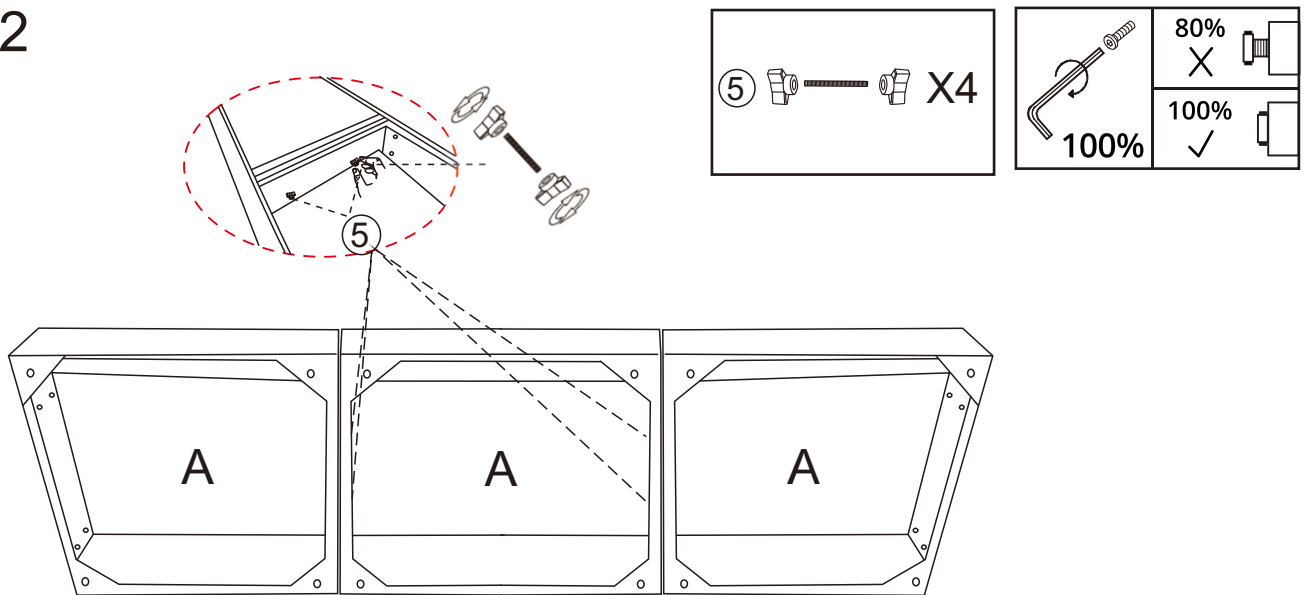

Step 3

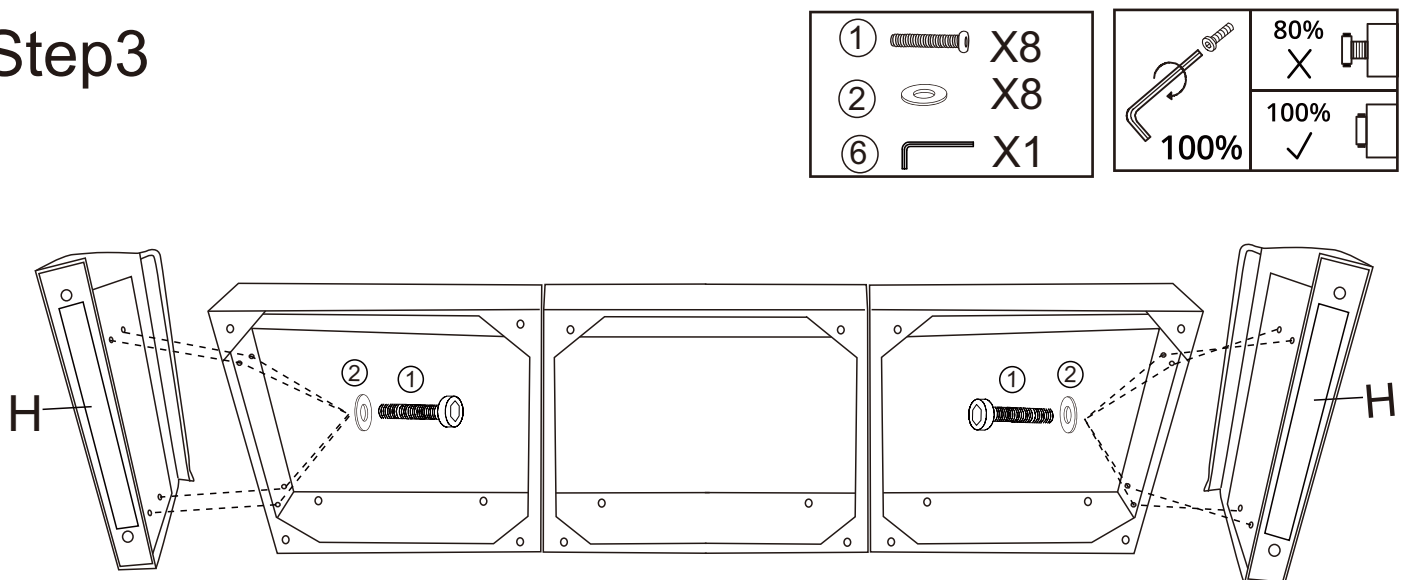

Assembly Instruction

Step4

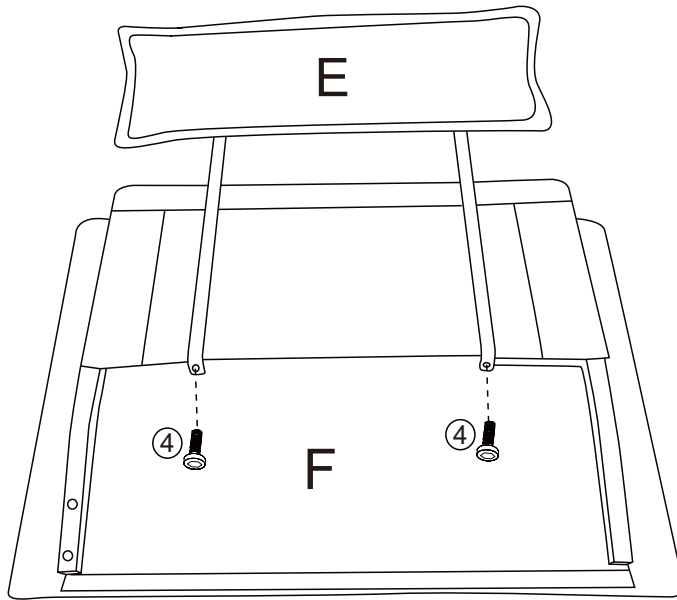
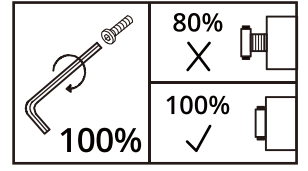
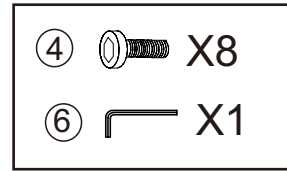
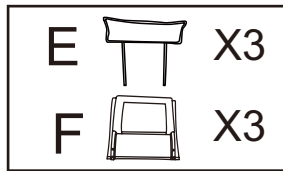

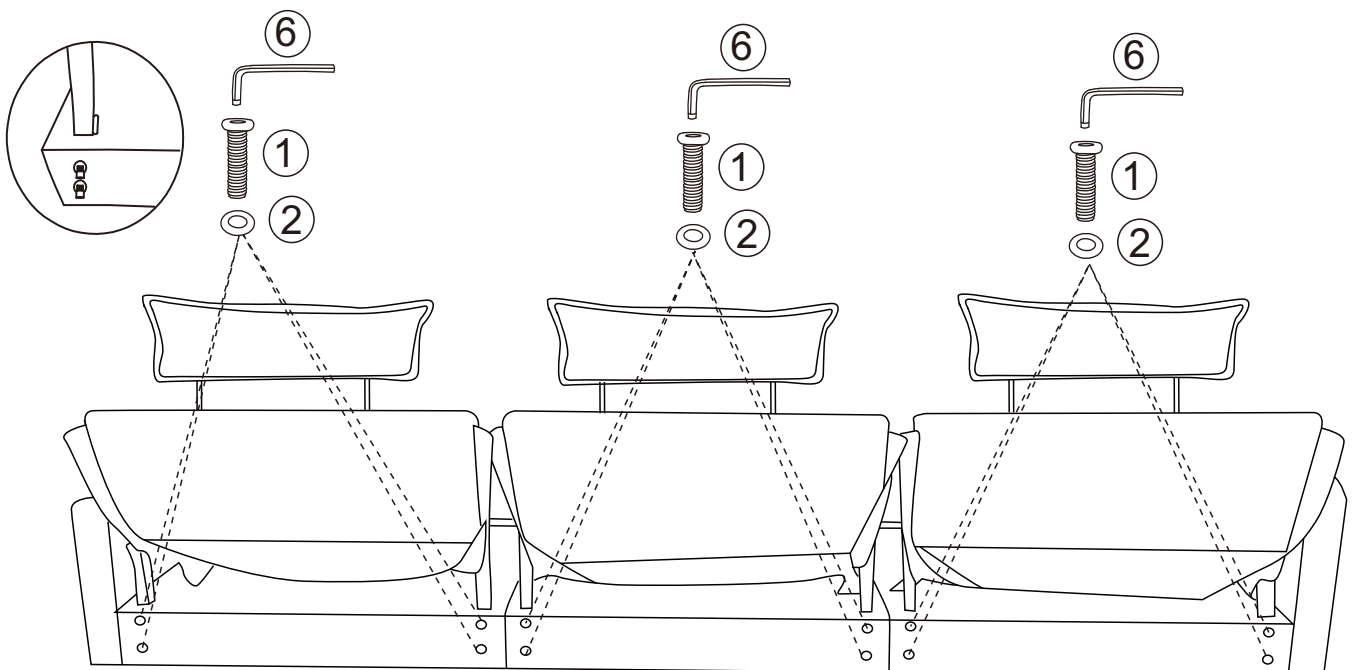
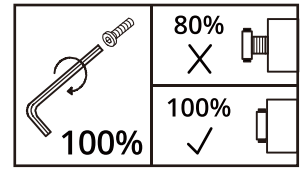
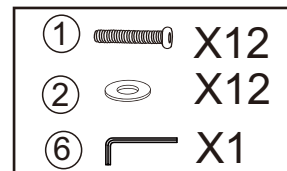

X3

Step5





Assembly Instruction

Step6

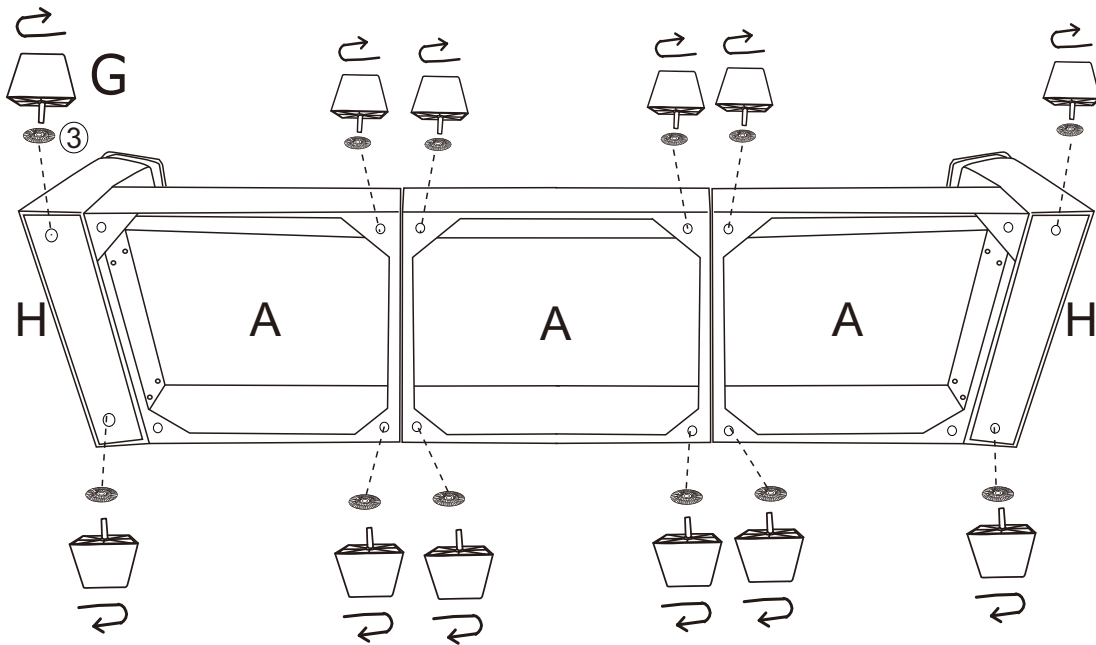
G		X12
③		X12



Step7

G		X4
③		X4

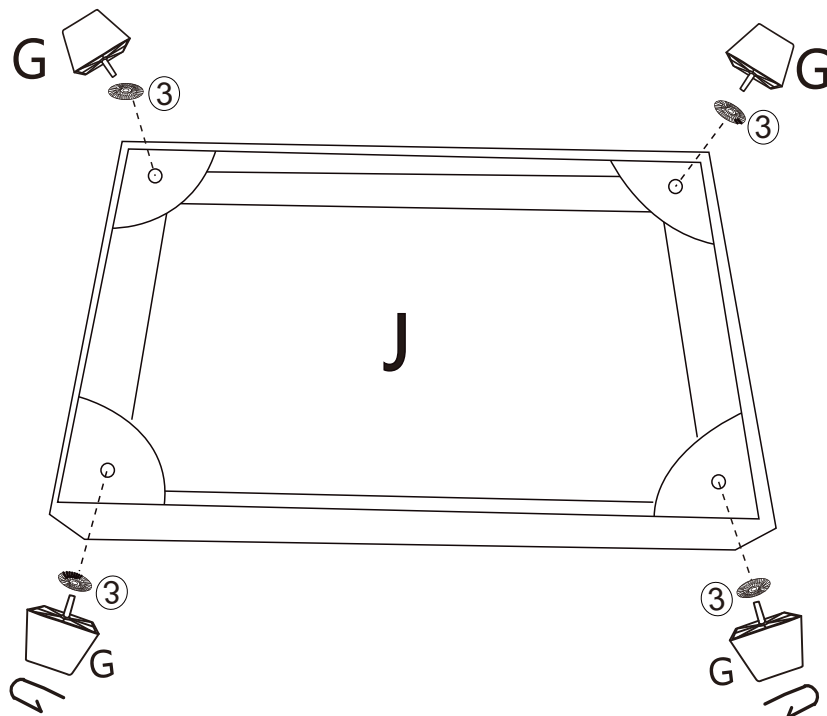

Assembly Instruction

Step8

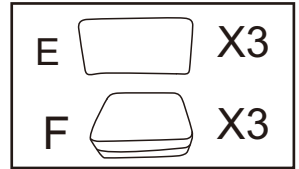
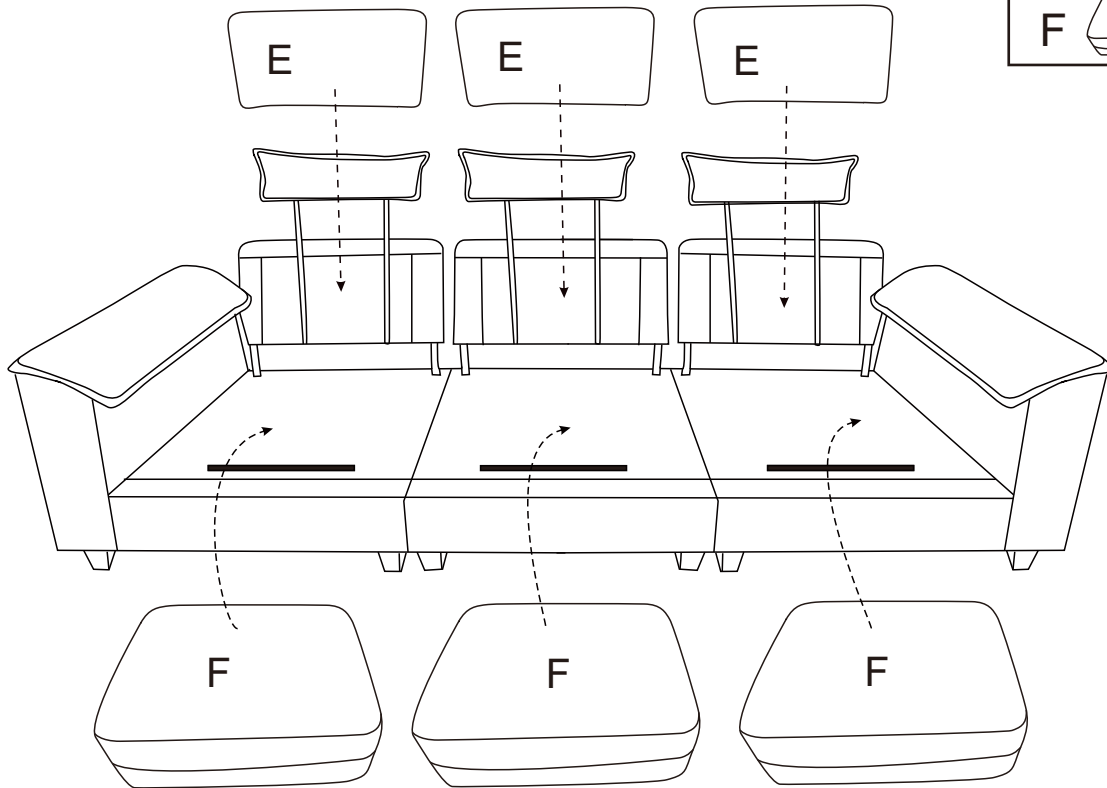

Step9

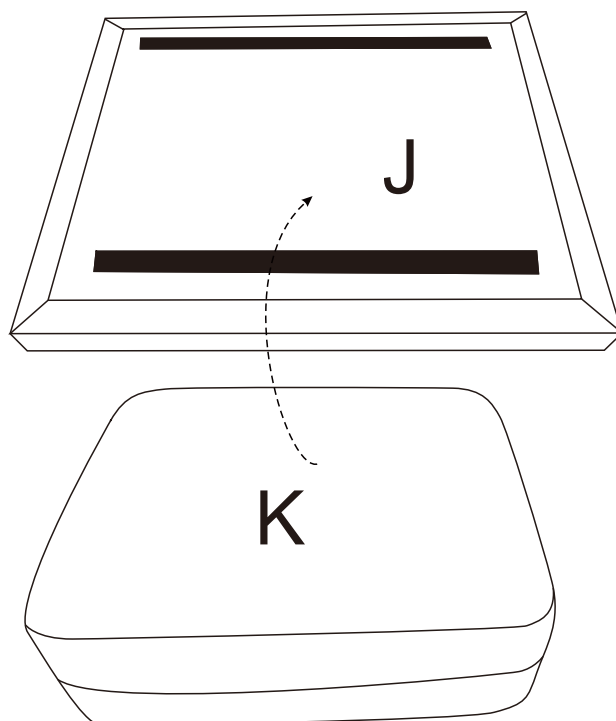

Assembly Instruction

Step 10

