

Assembly Instruction

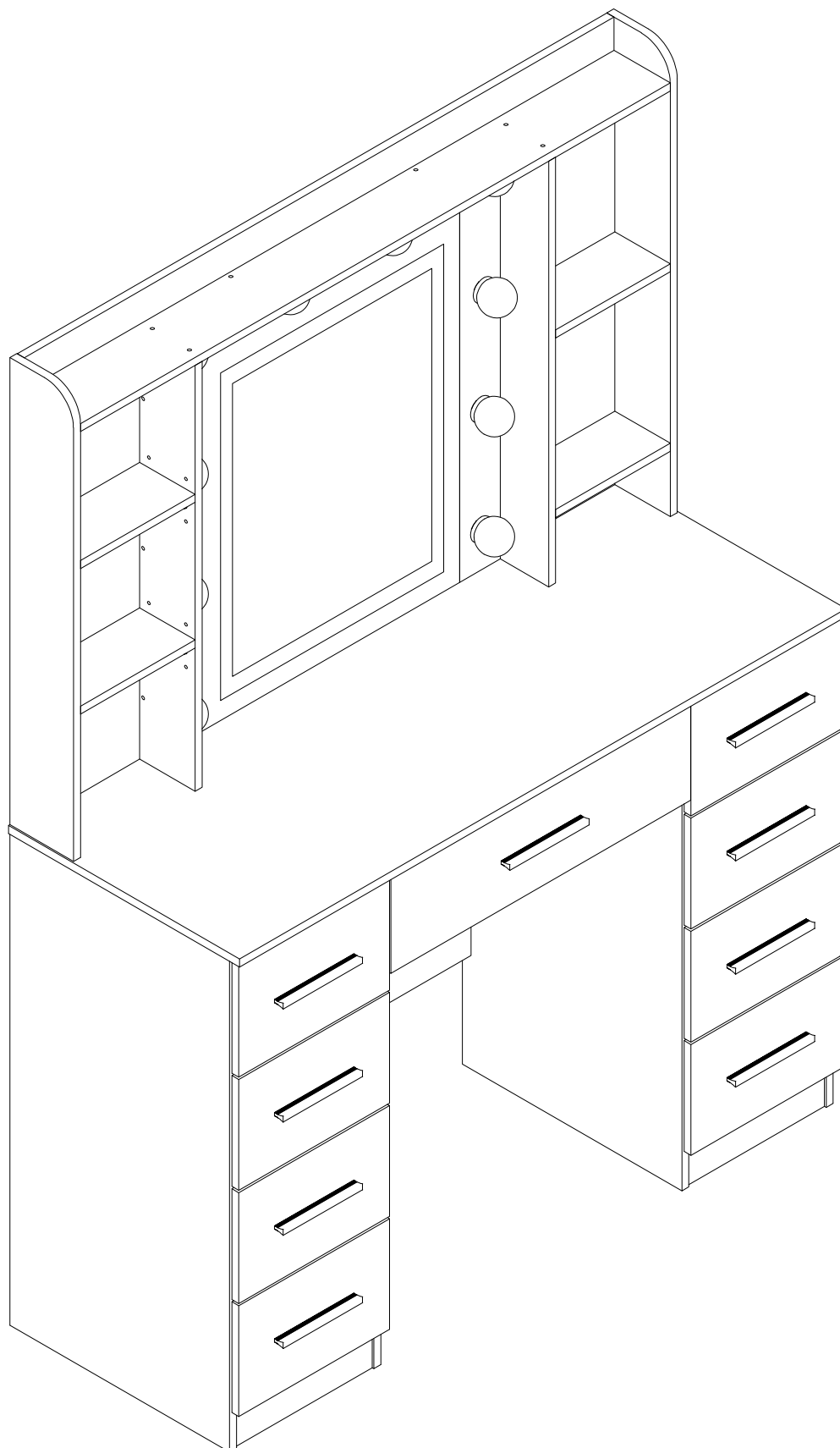

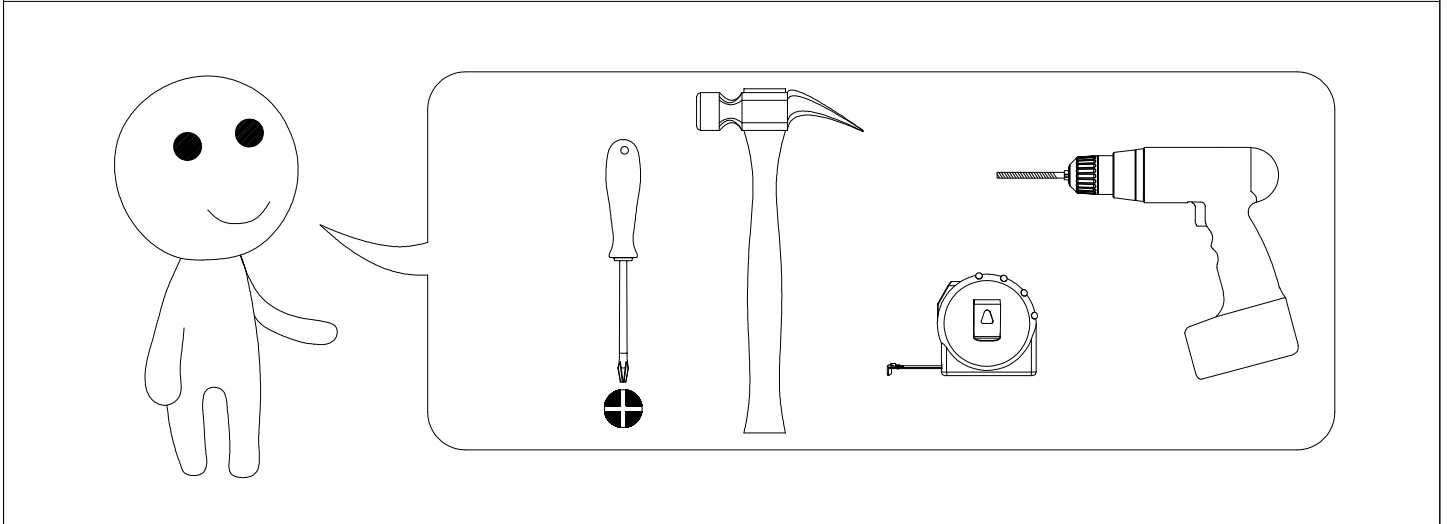
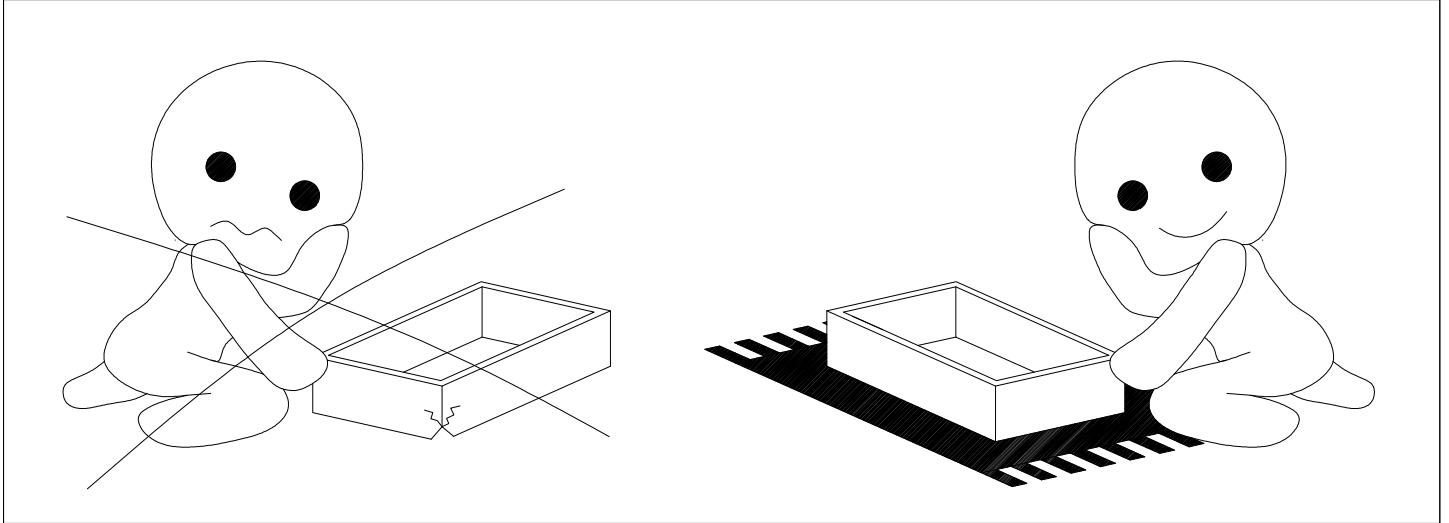
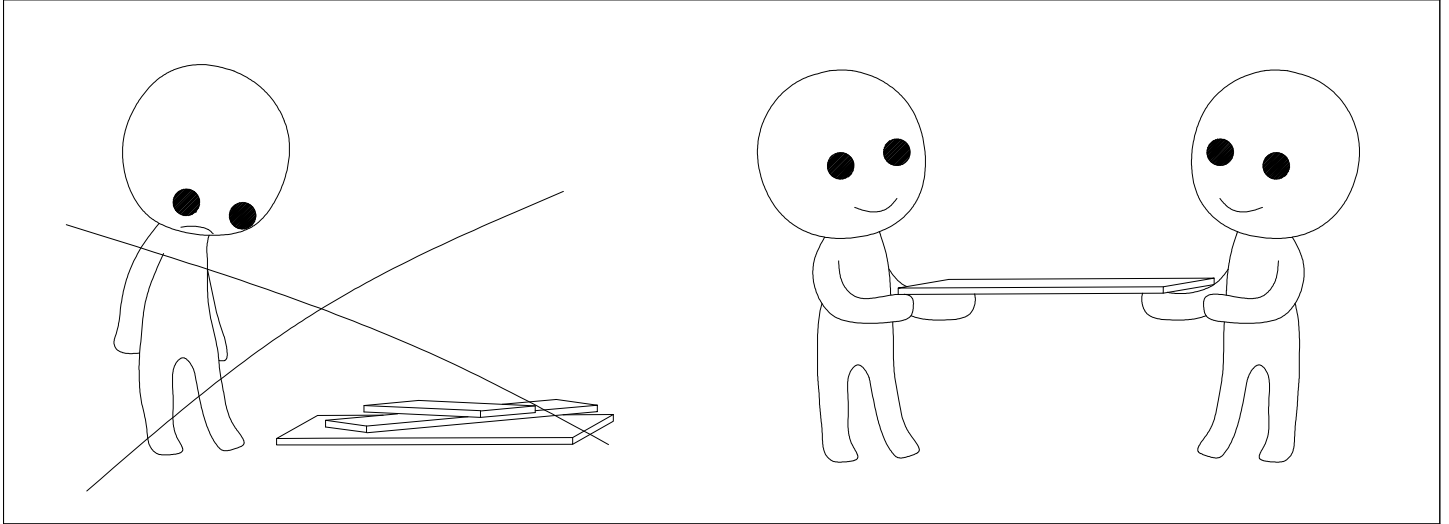
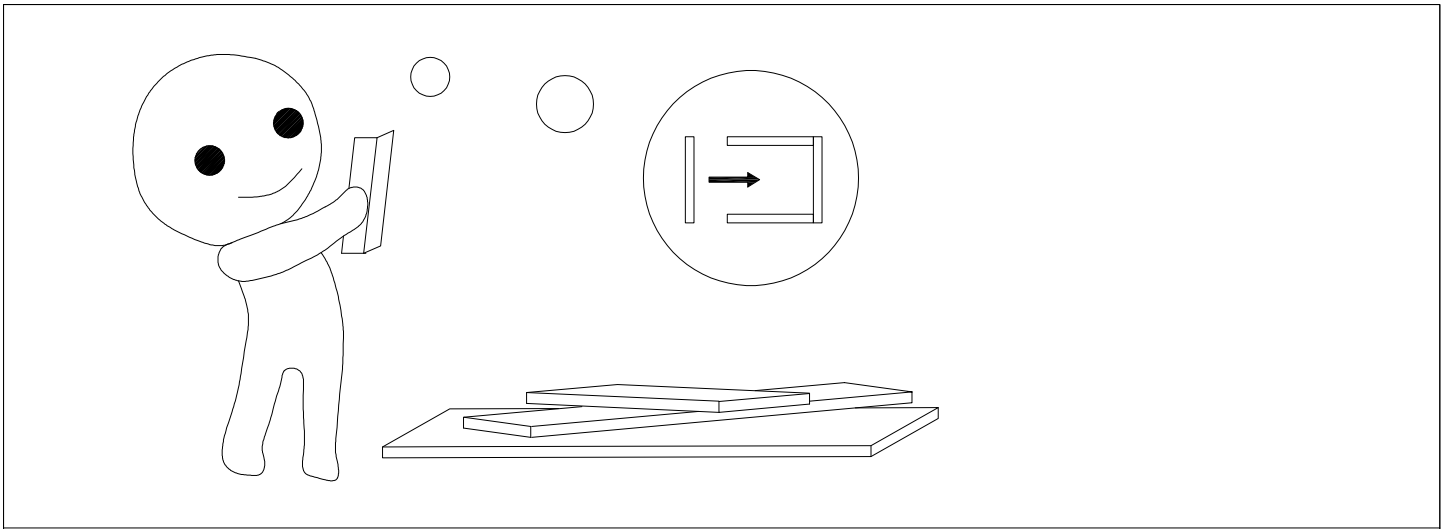
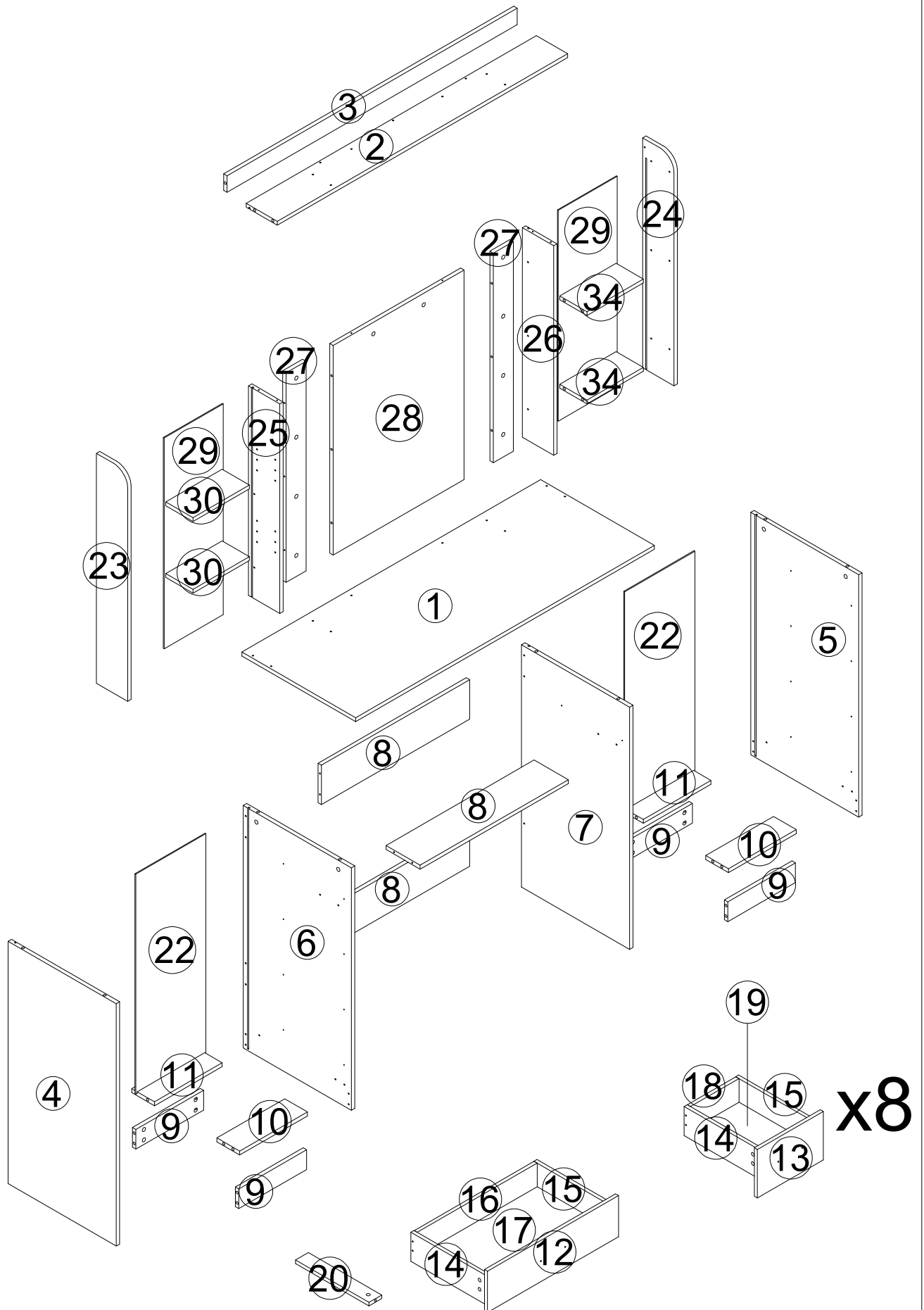
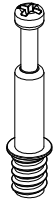

PLATE NUMBER



ACCESSORIES LIST

A ×93



M6×35

B ×93

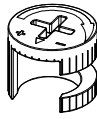

12×10

C ×74



M5×40

D ×72

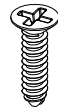

M3×12

E ×9

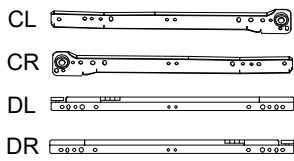

M300

F ×8

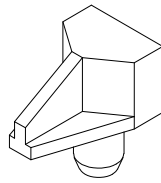

G ×5



H ×9

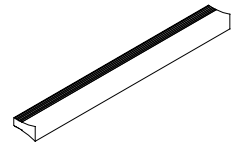

J ×18

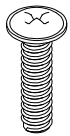

M4×14

K ×10

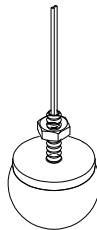

L ×1

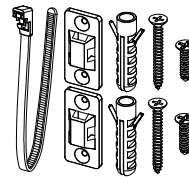

M ×10

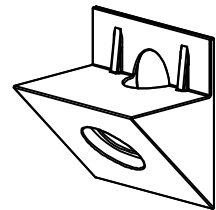

N ×10

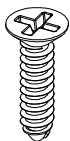

M3.5×14

×1

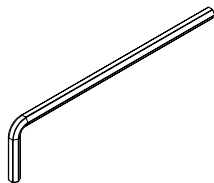

STEP 1

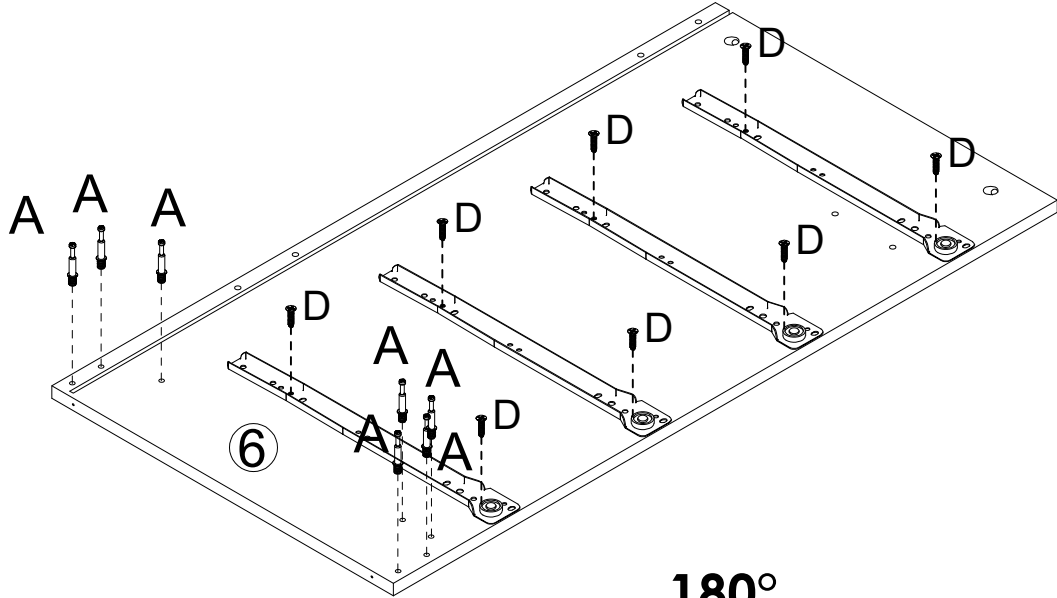
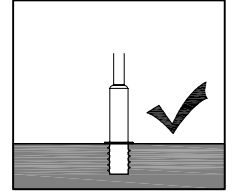
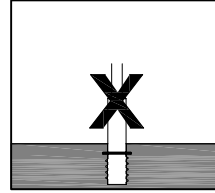
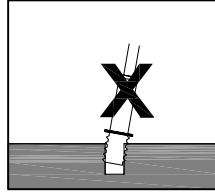
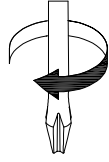

180°

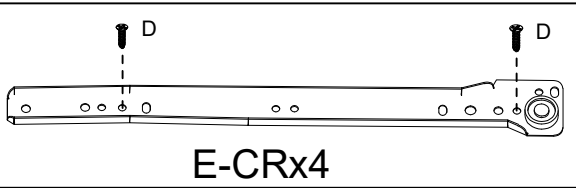

E-CRx4

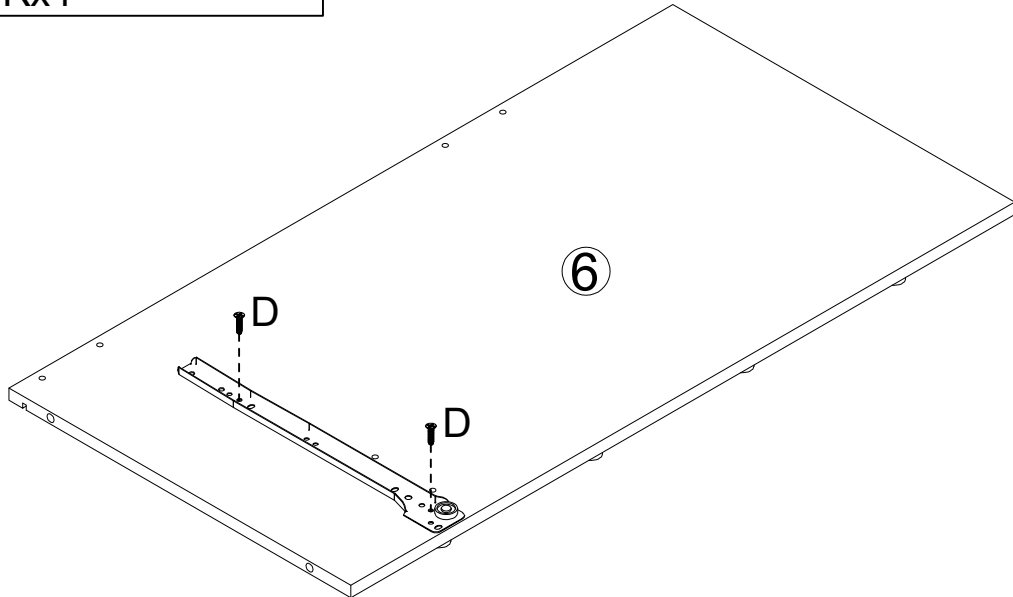

6

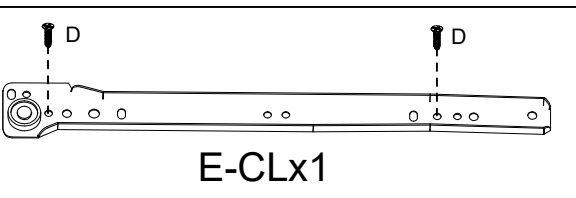

E-CLx1

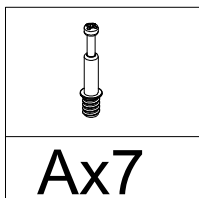

Ax7

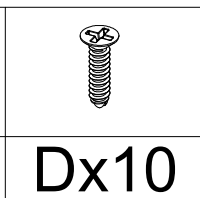

Dx10

STEP2

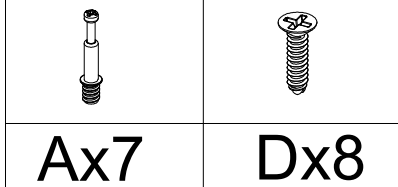
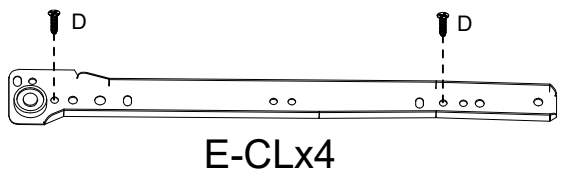
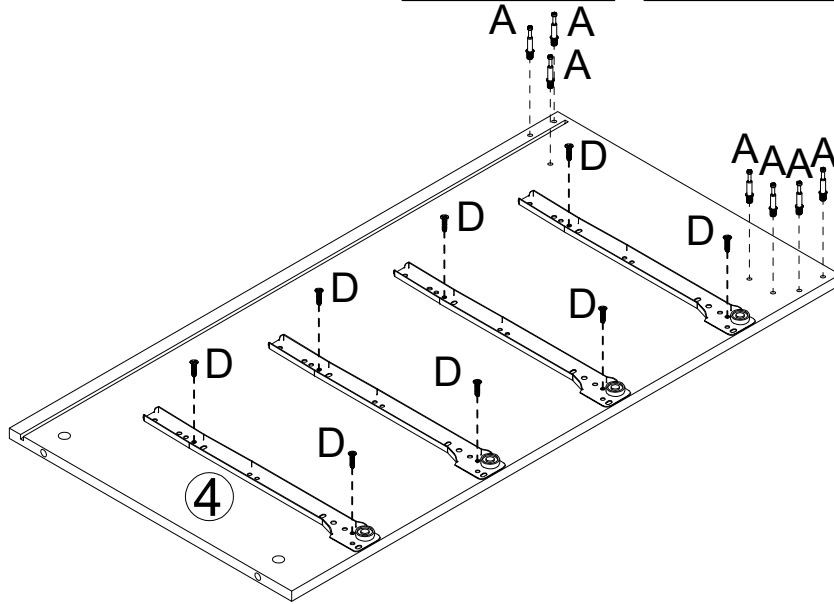
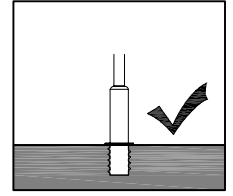
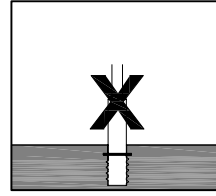
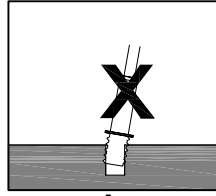
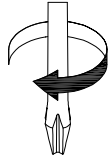

STEP3

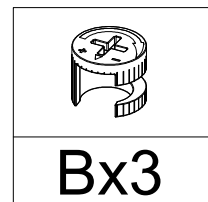
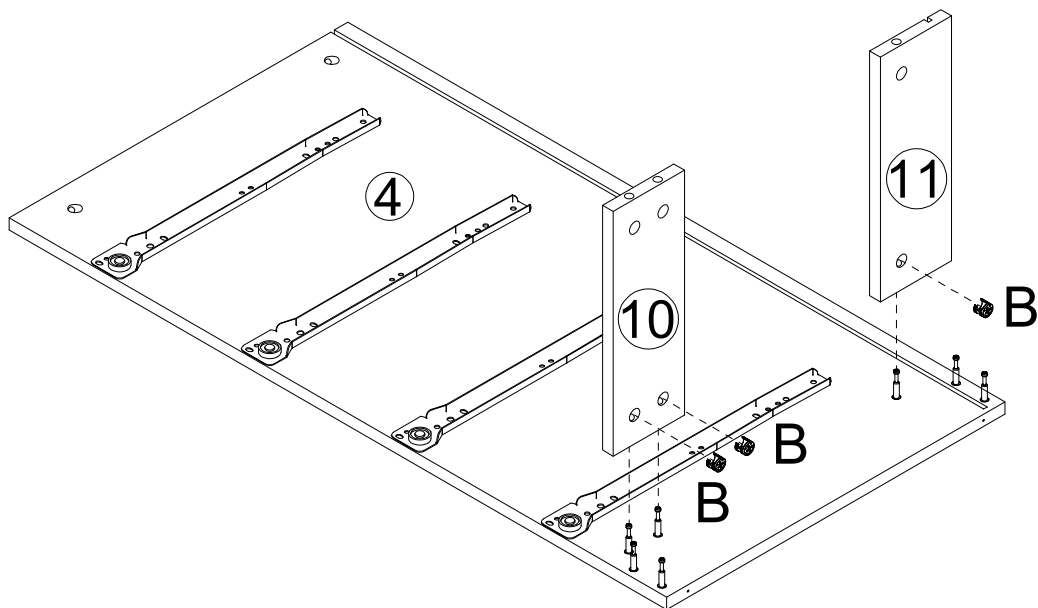
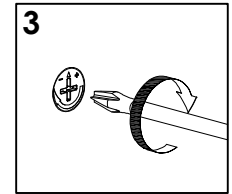
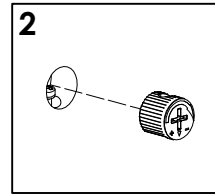
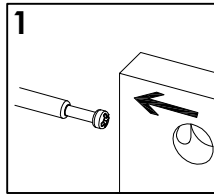
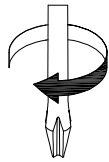

STEP4

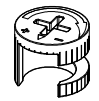
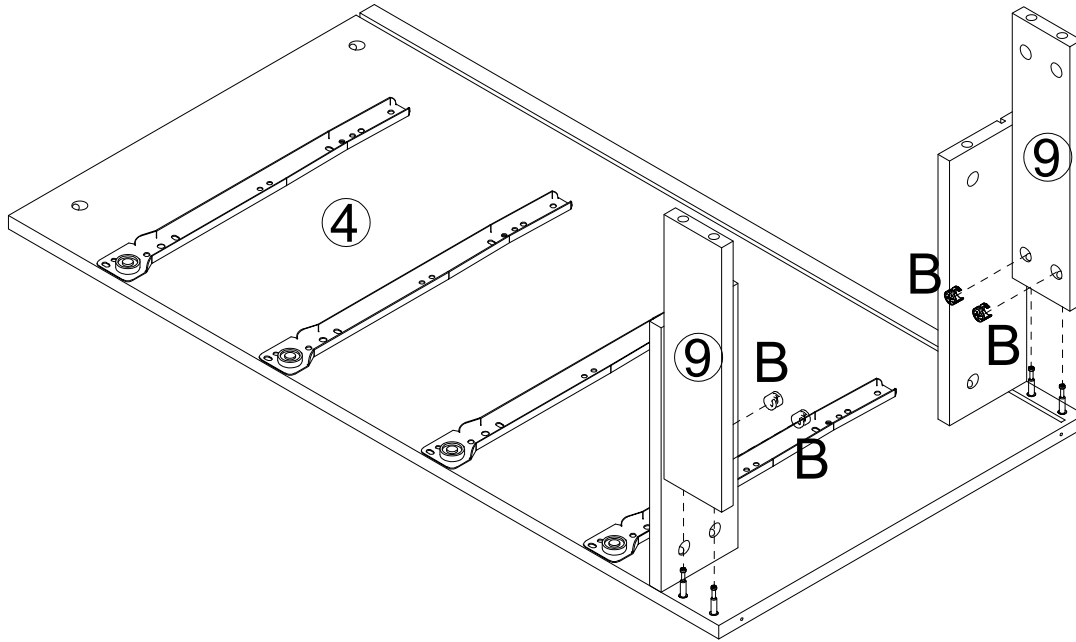
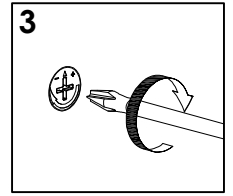
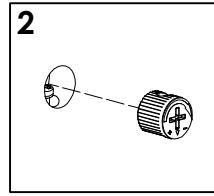
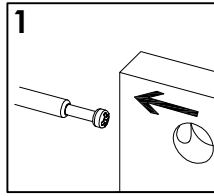
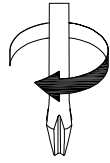

Bx4

STEP5

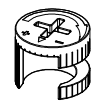
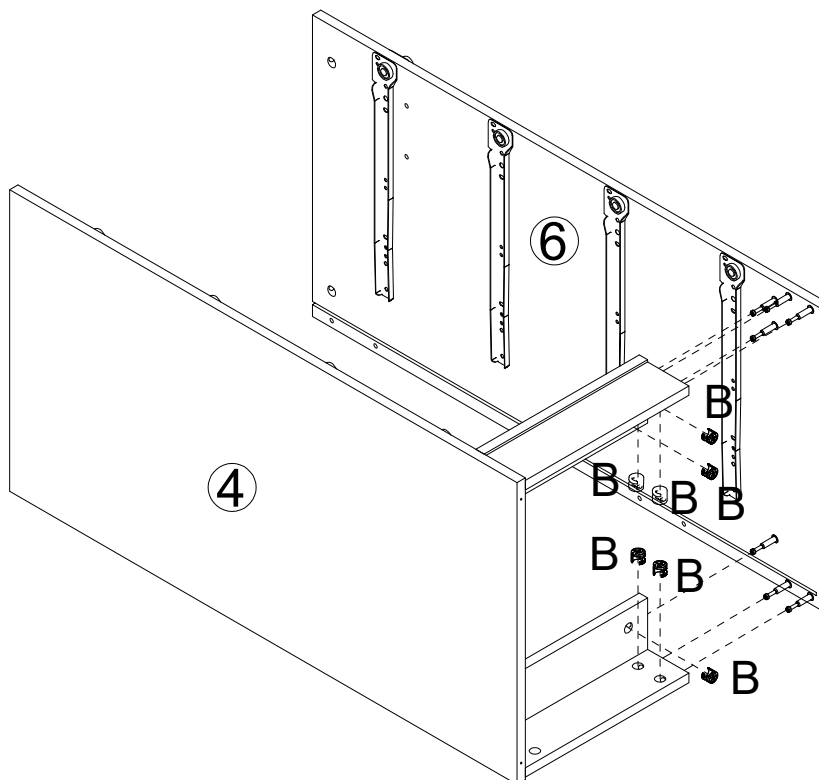
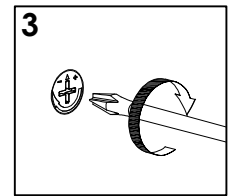
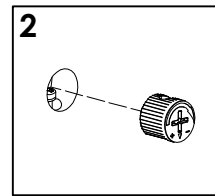
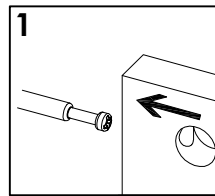
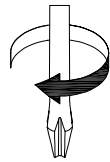

Bx7

STEP 6

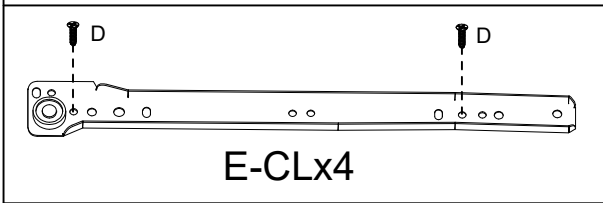
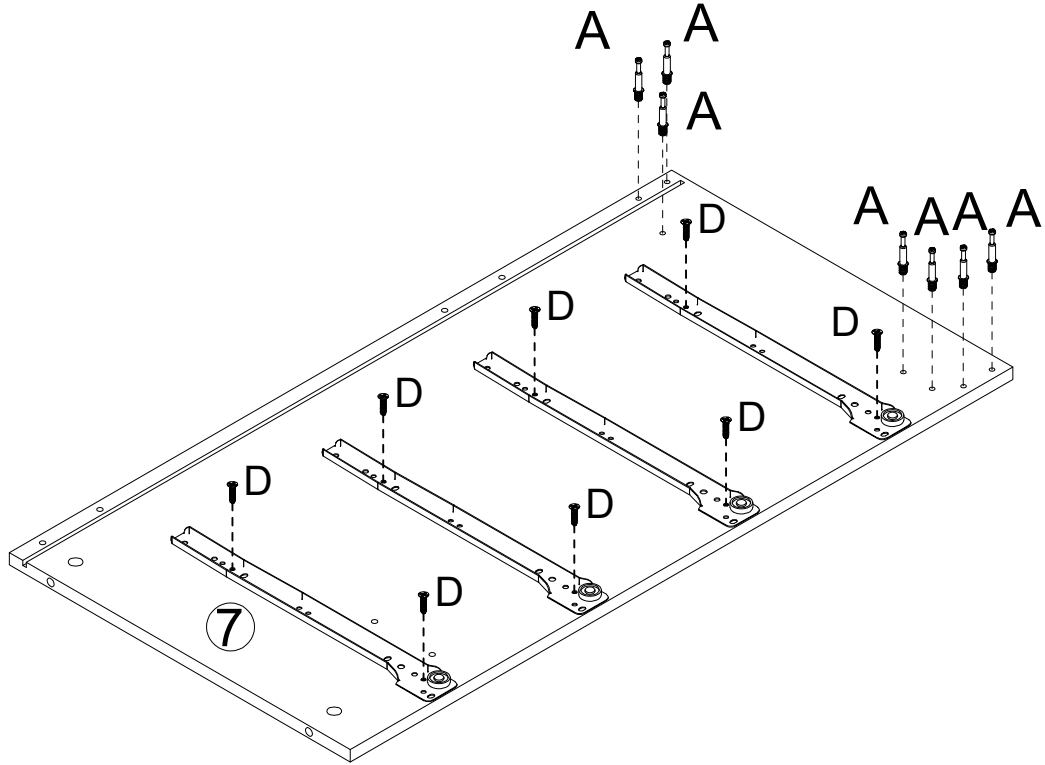
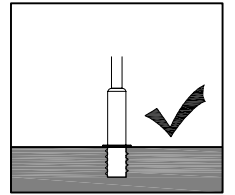
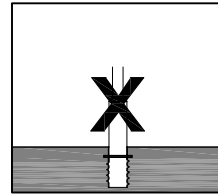
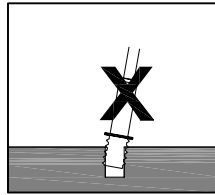
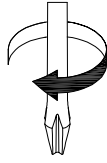

E-CLx4

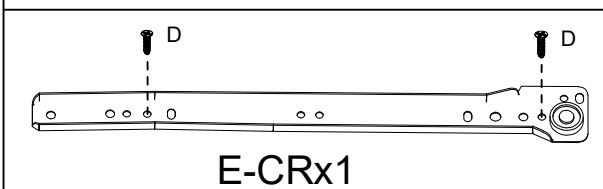
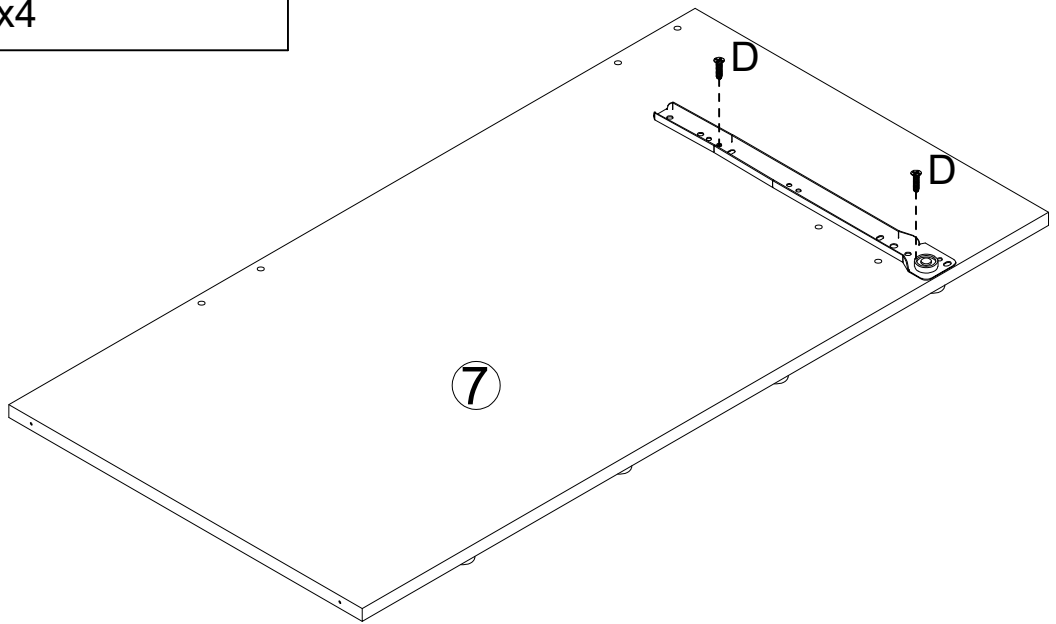

E-CRx1

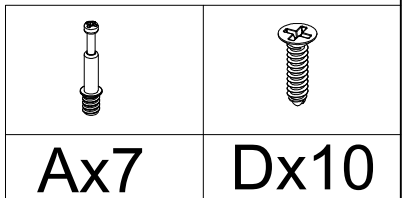

STEP 7

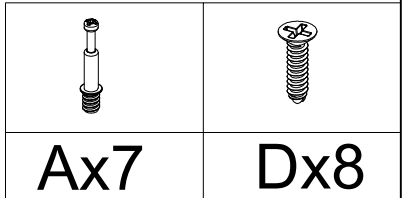
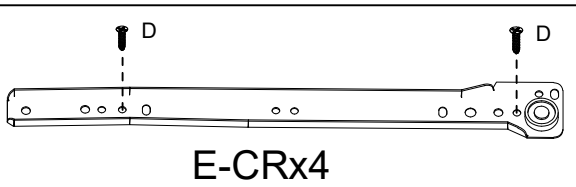
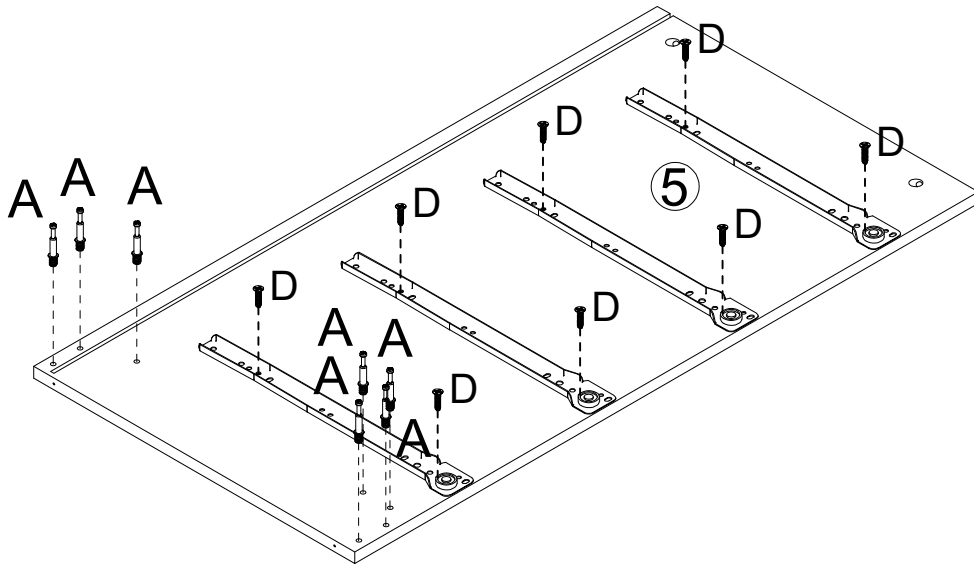
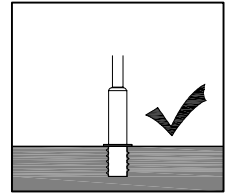
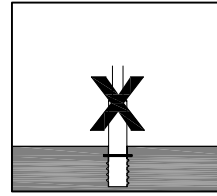
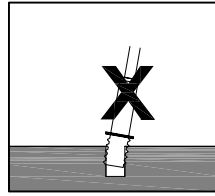
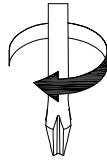

STEP 8

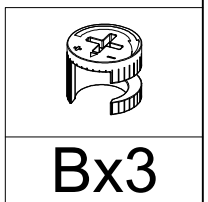
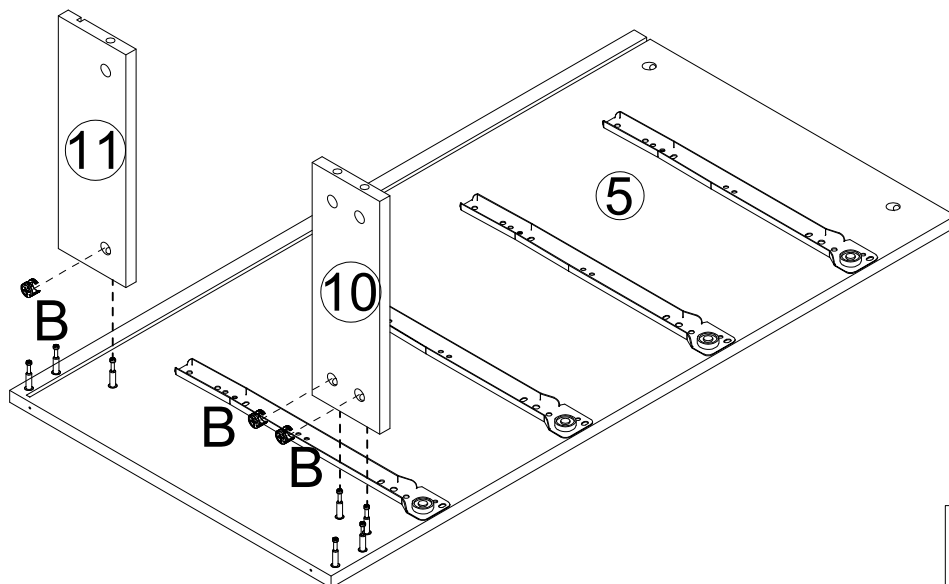
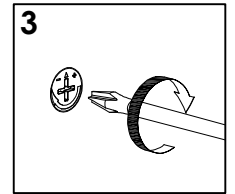
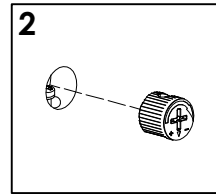
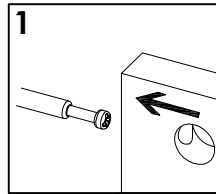
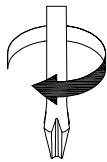

STEP 9

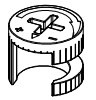
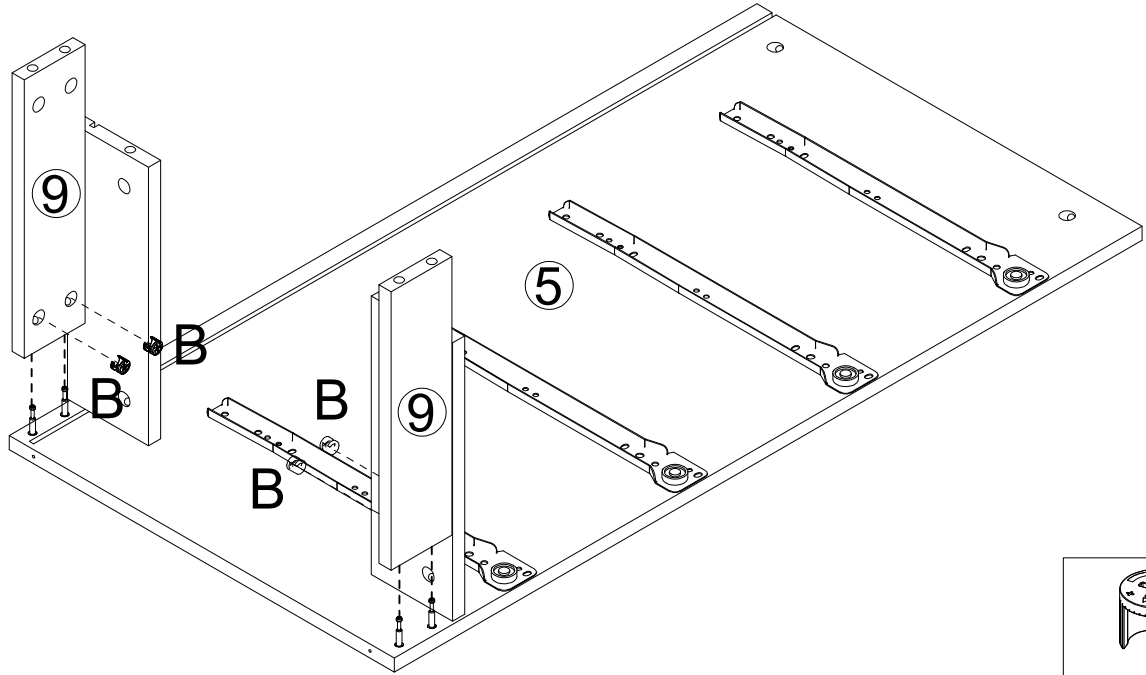
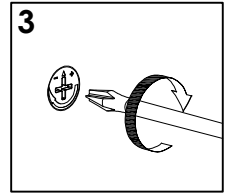
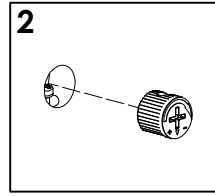
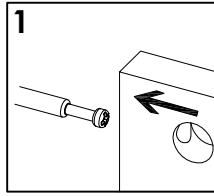
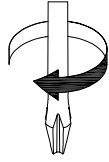

Bx4

STEP 10

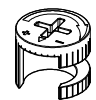
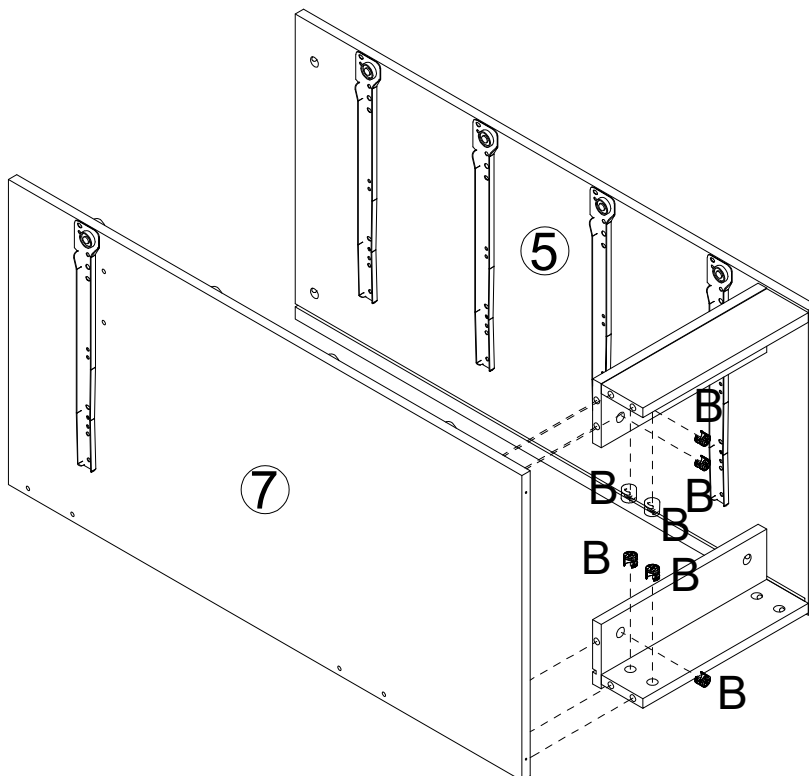
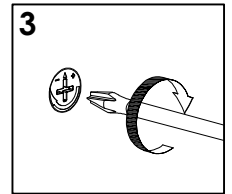
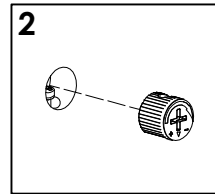
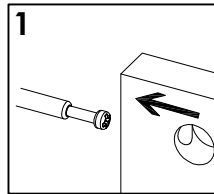
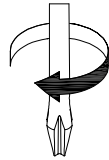

Bx7

STEP11

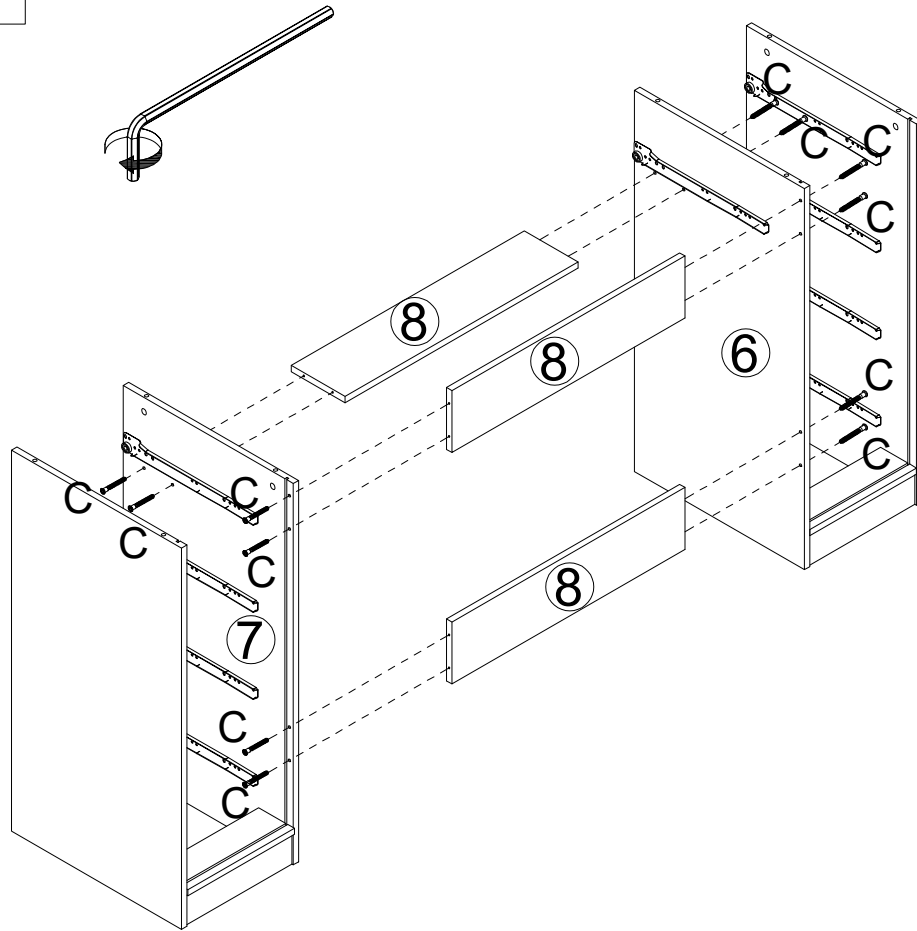

Cx12

STEP12

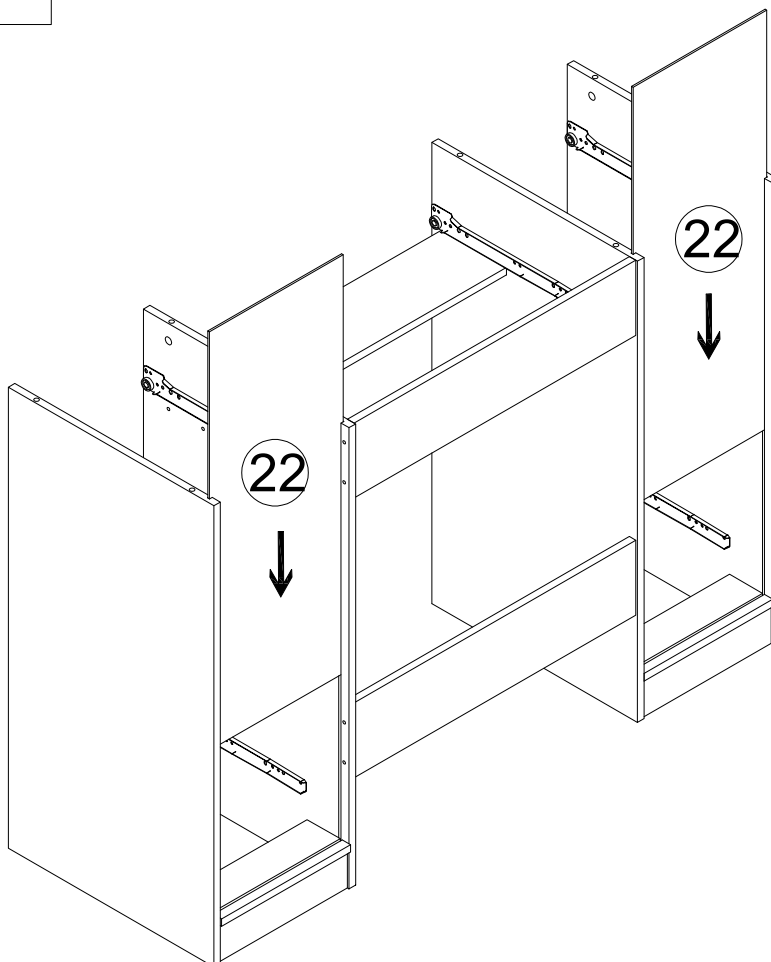

STEP13

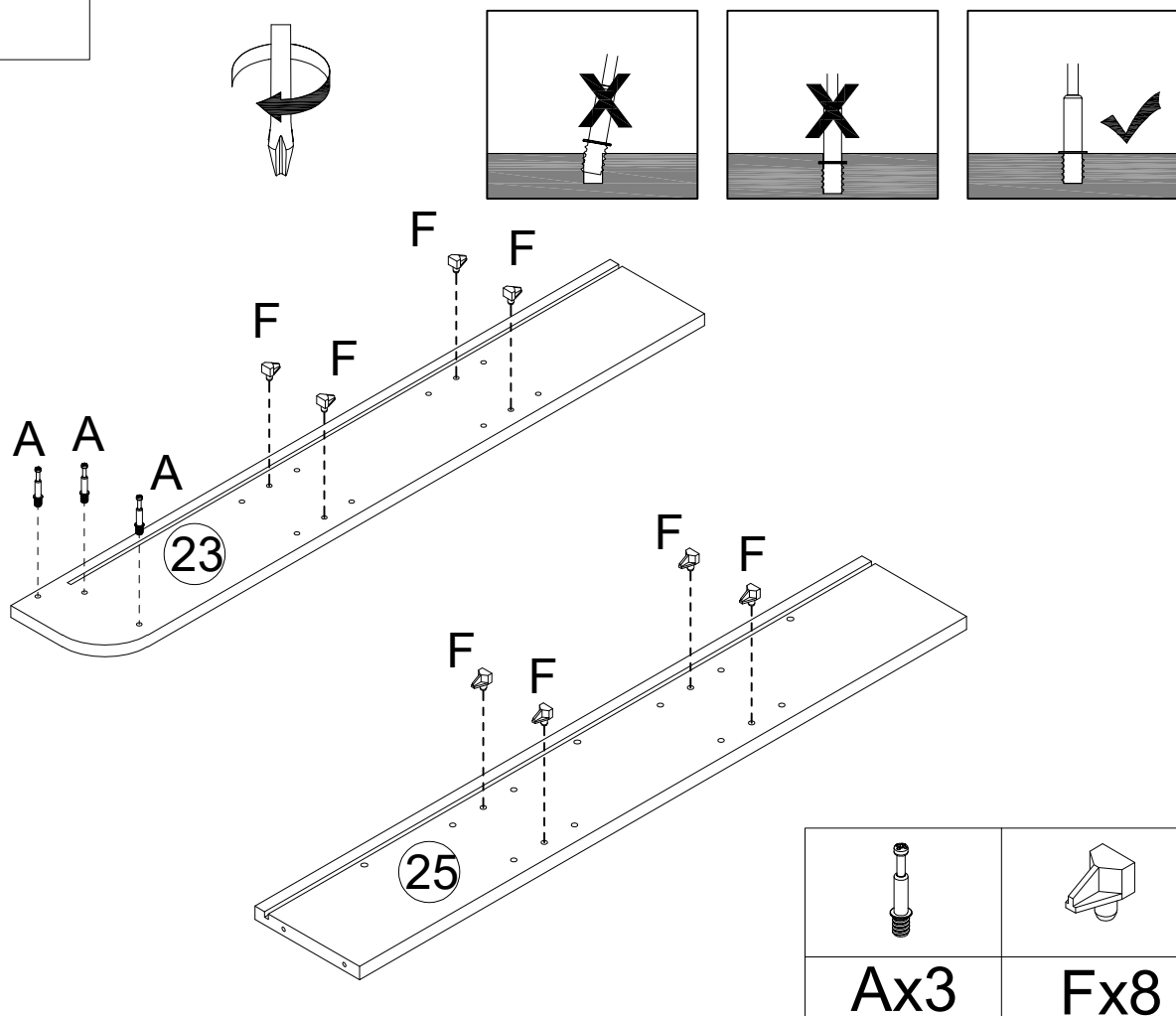

STEP14

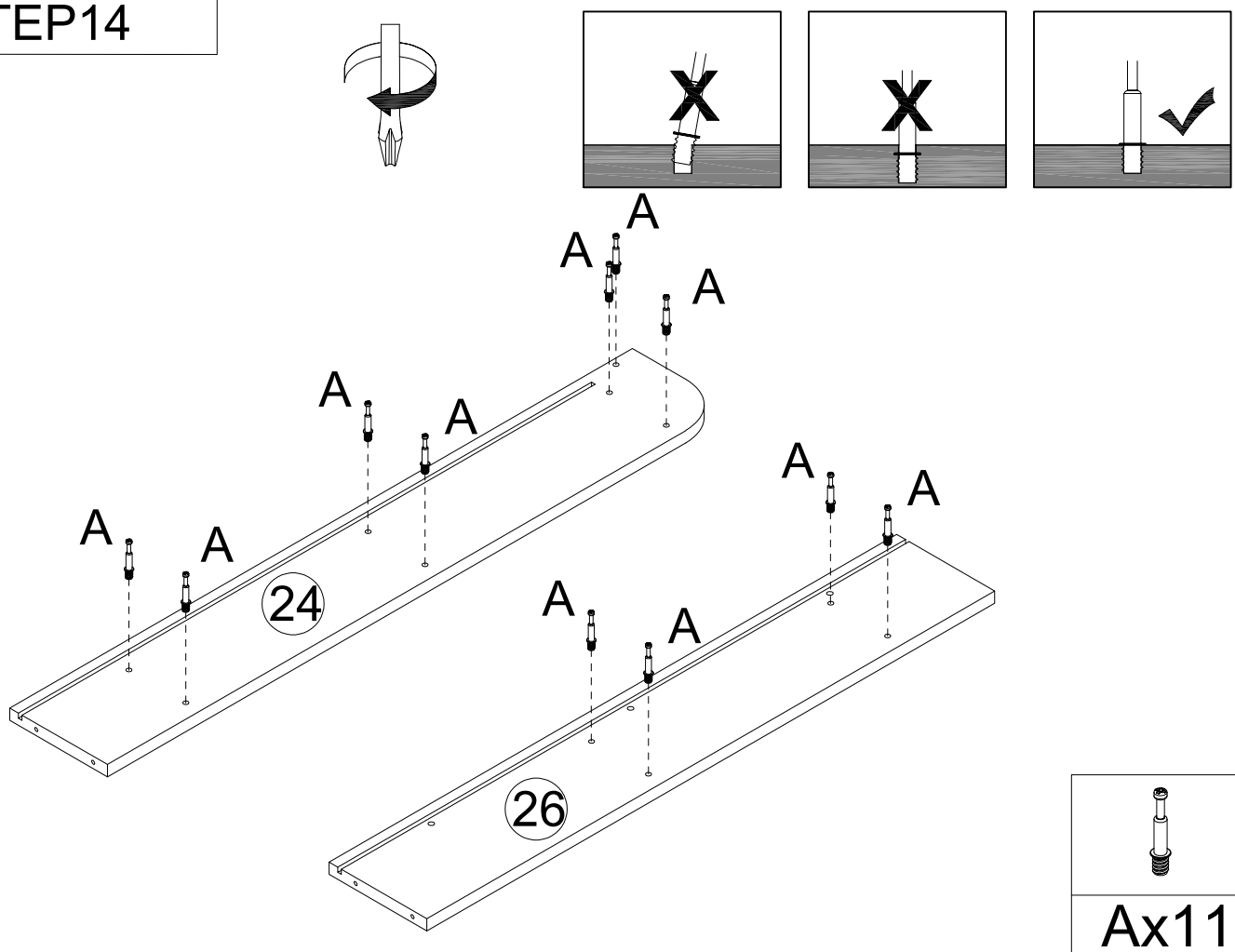

STEP 15

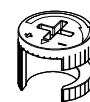
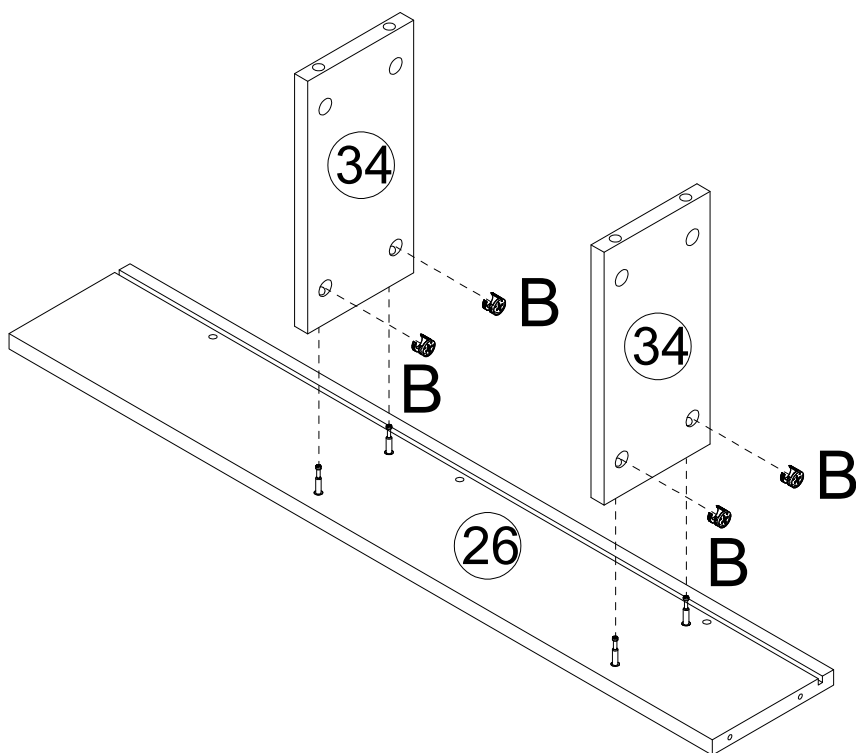
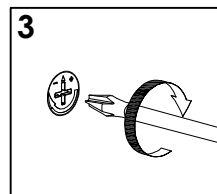
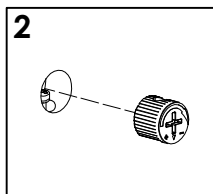
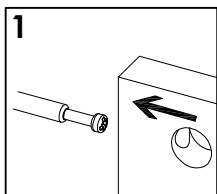
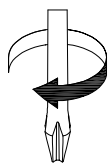

Bx4

STEP 16

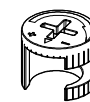
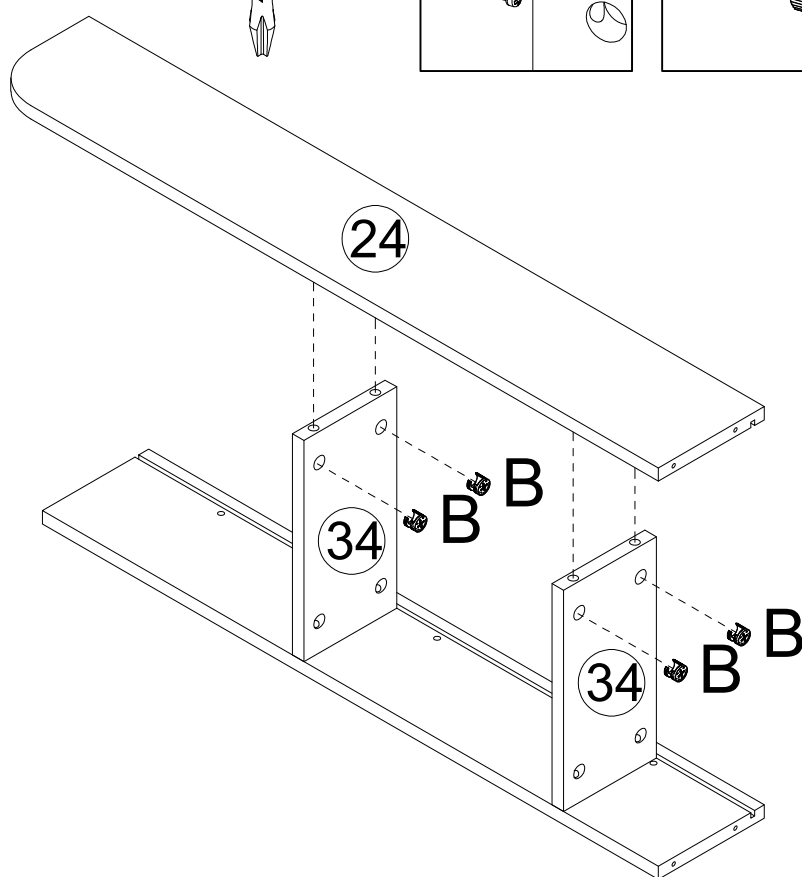
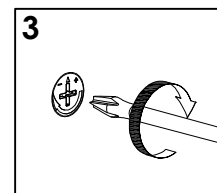
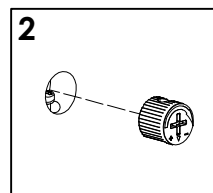
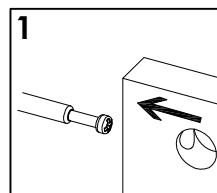
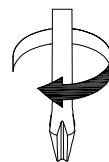

Bx4

STEP17

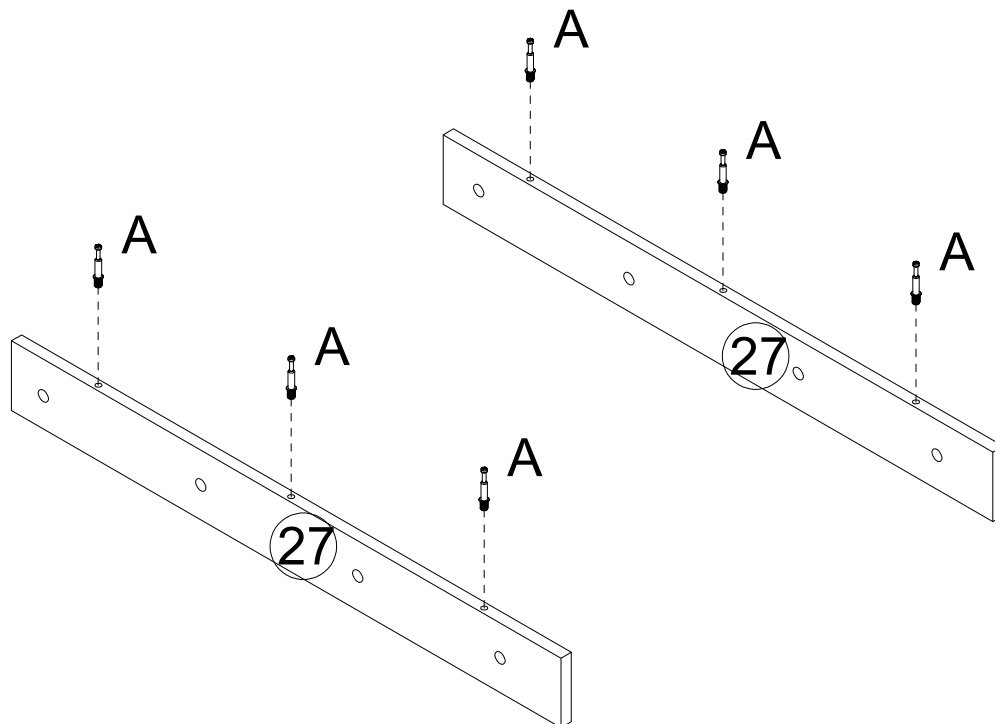
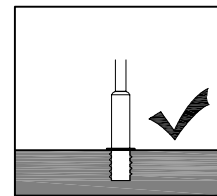
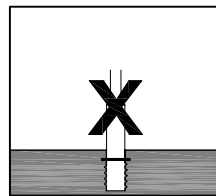
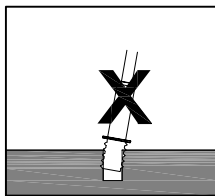
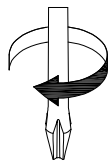

Ax6

STEP18

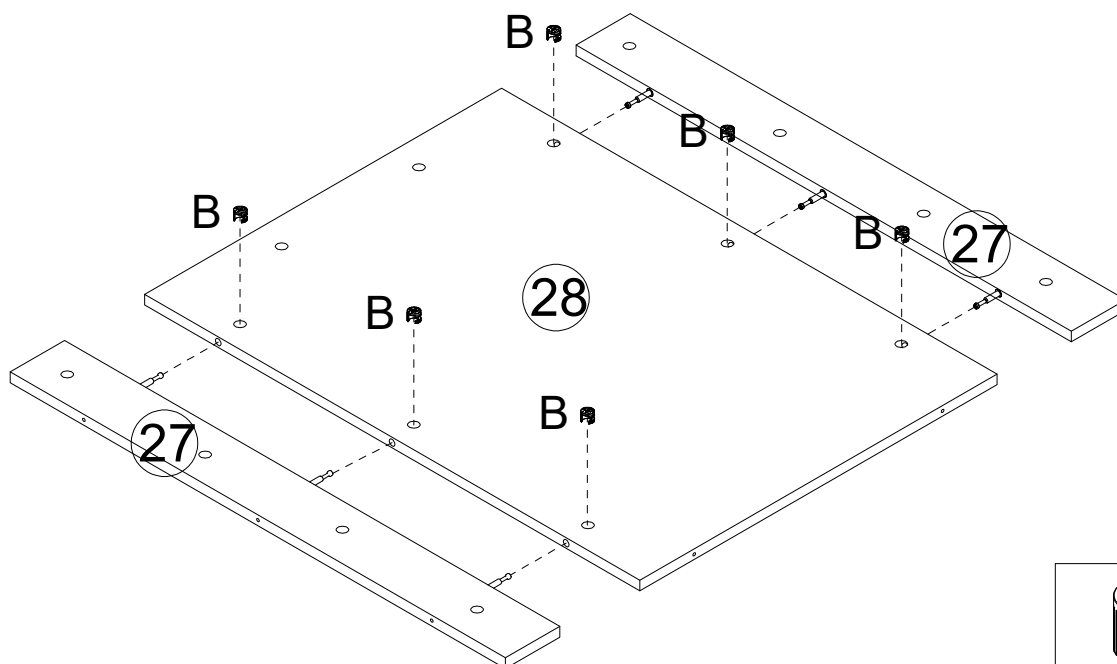
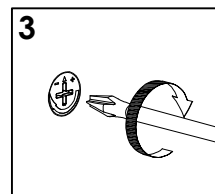
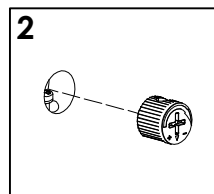
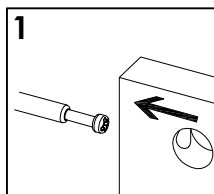
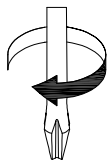

Bx6

STEP19

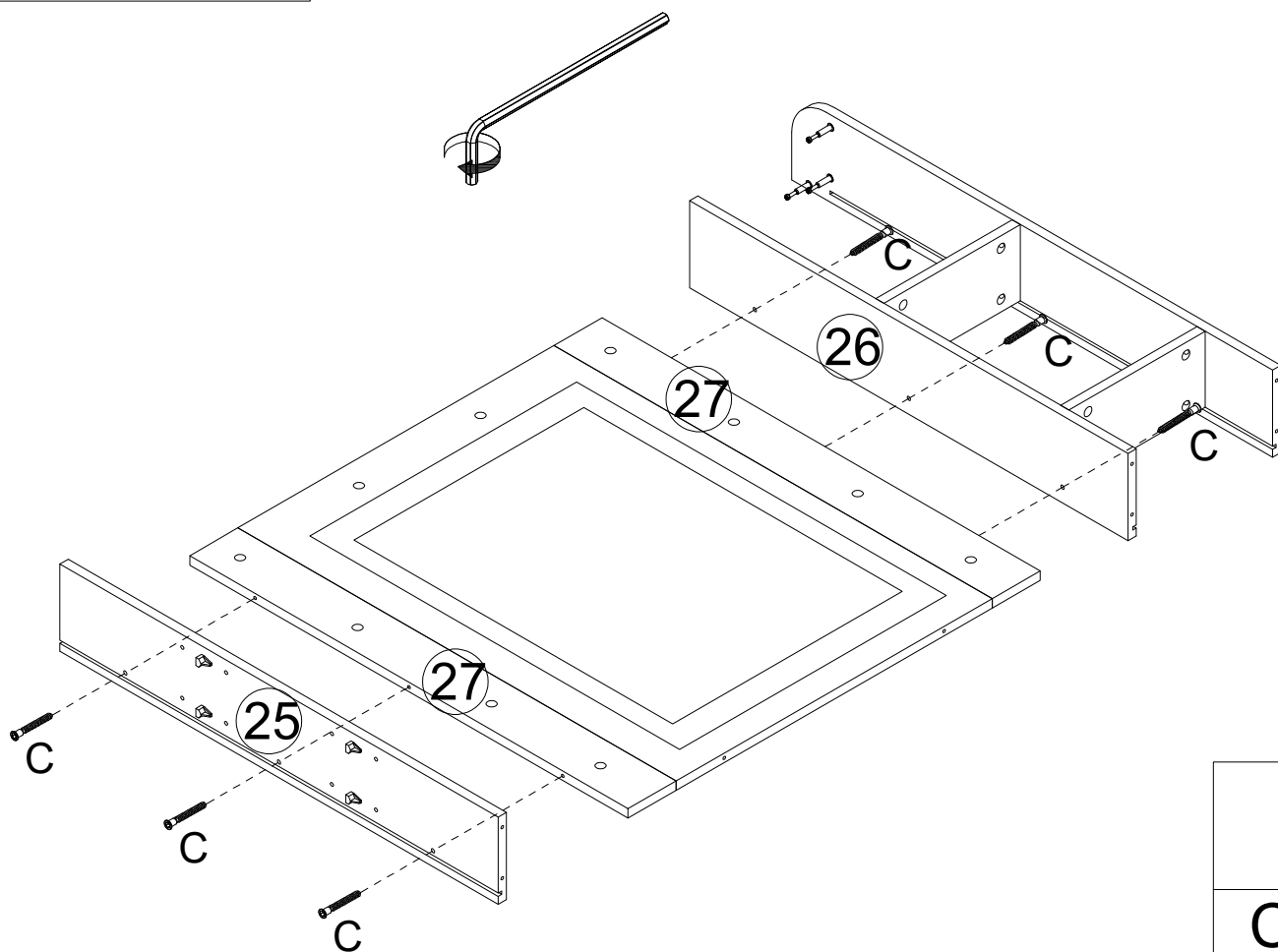

STEP20

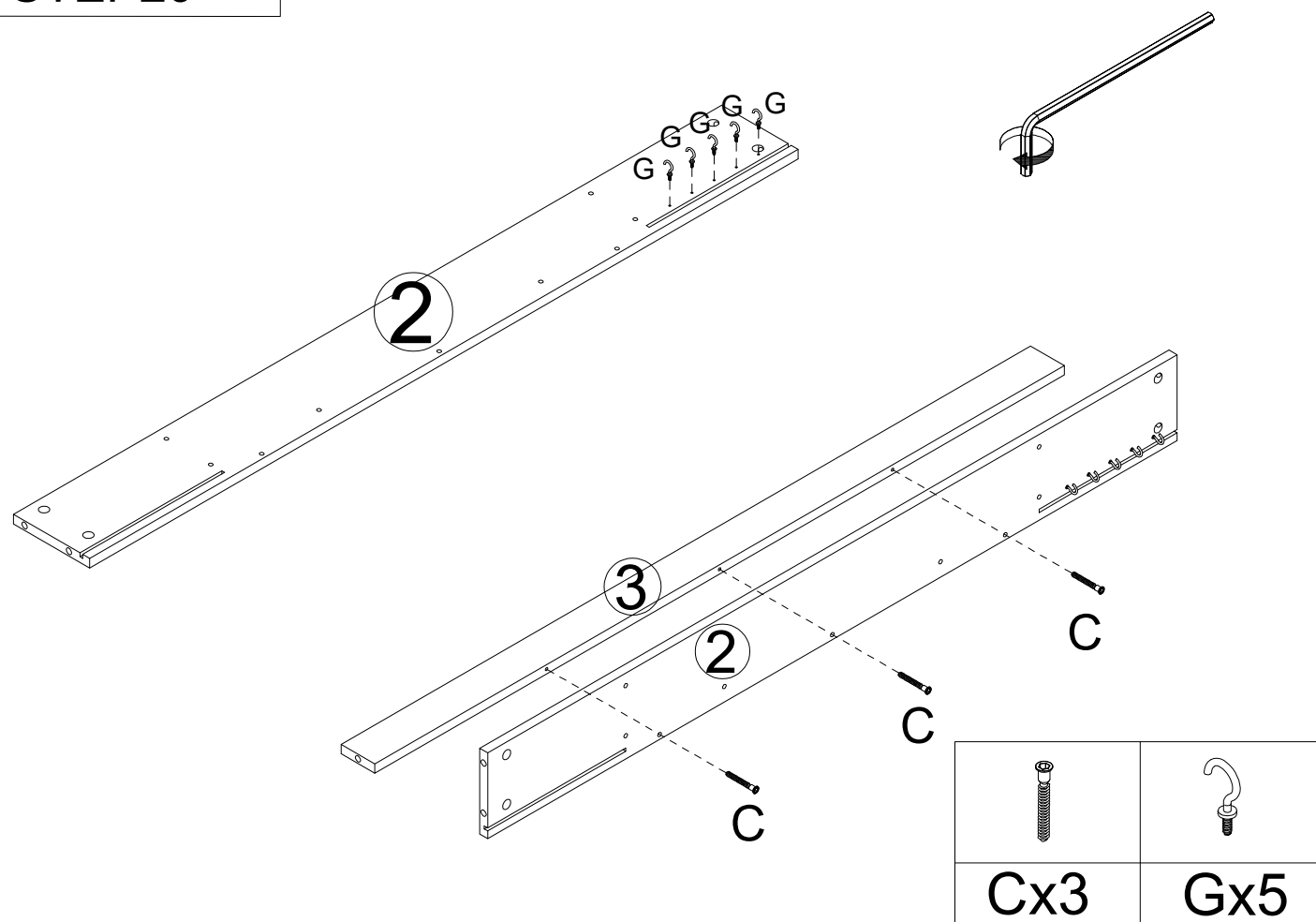

STEP21

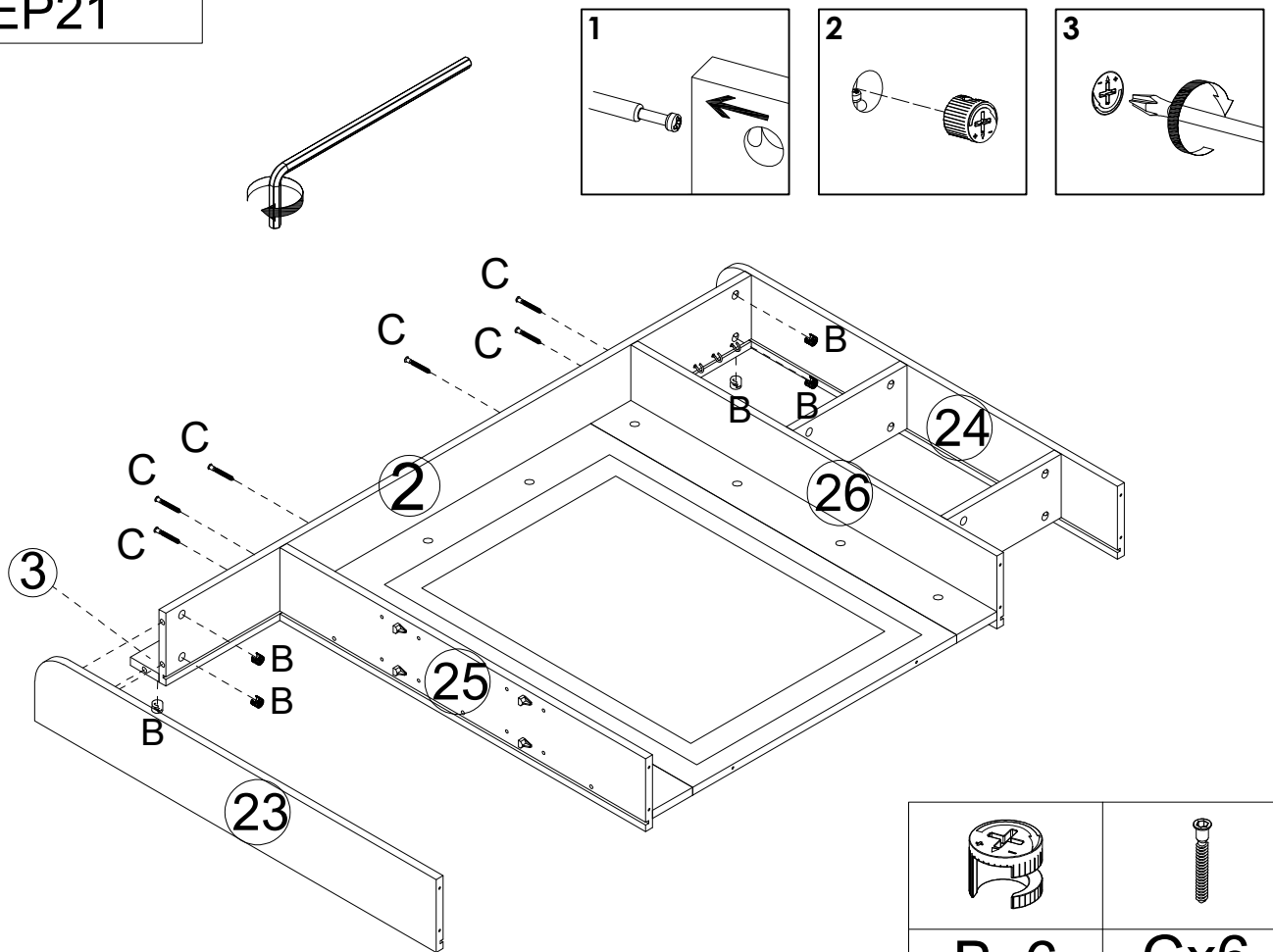

STEP22

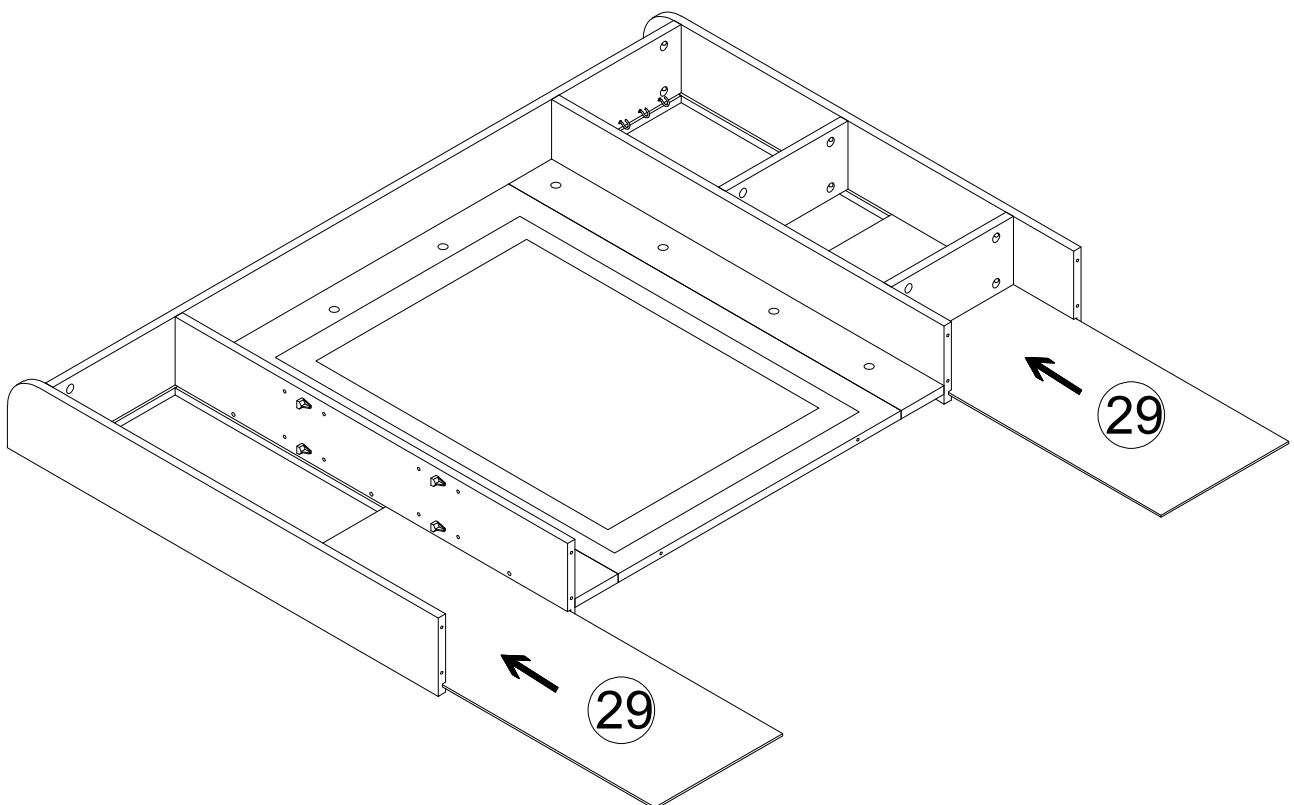

STEP23

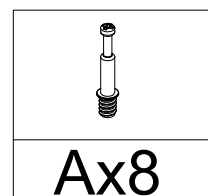
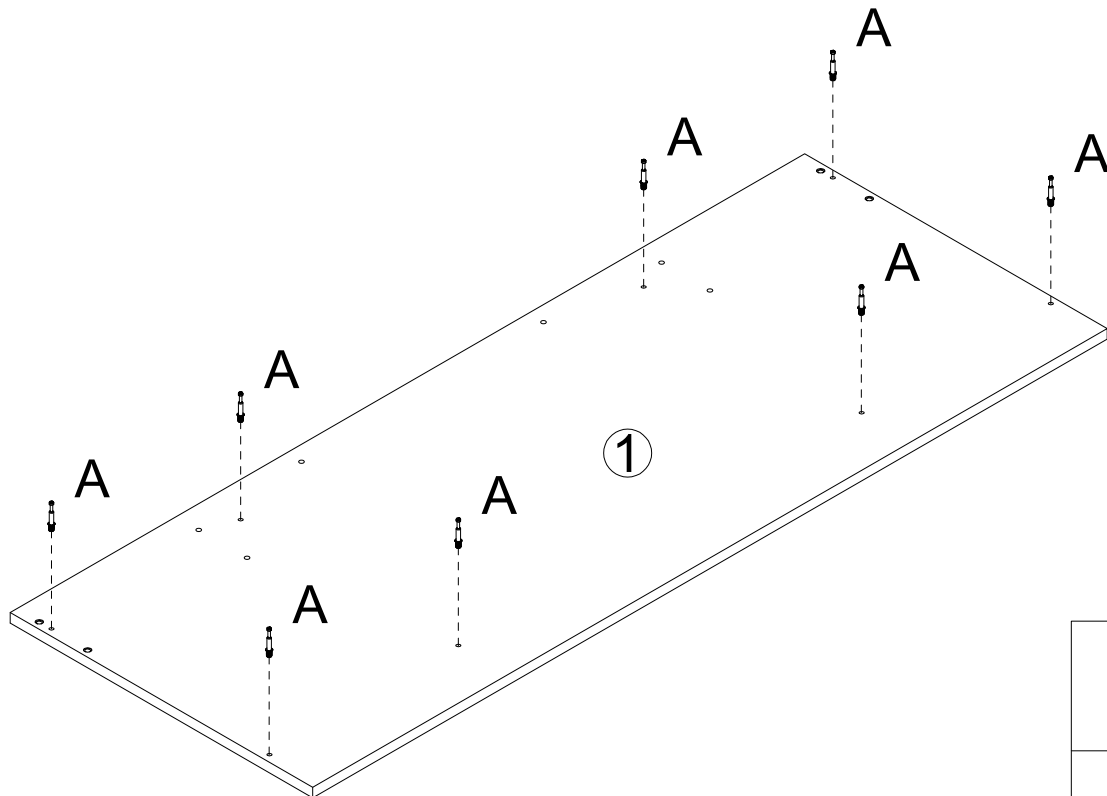
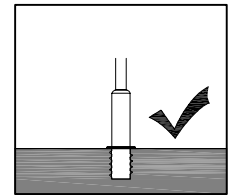
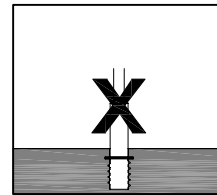
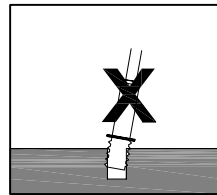
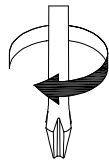

STEP24

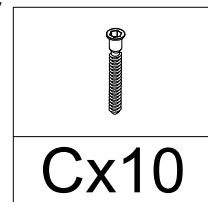
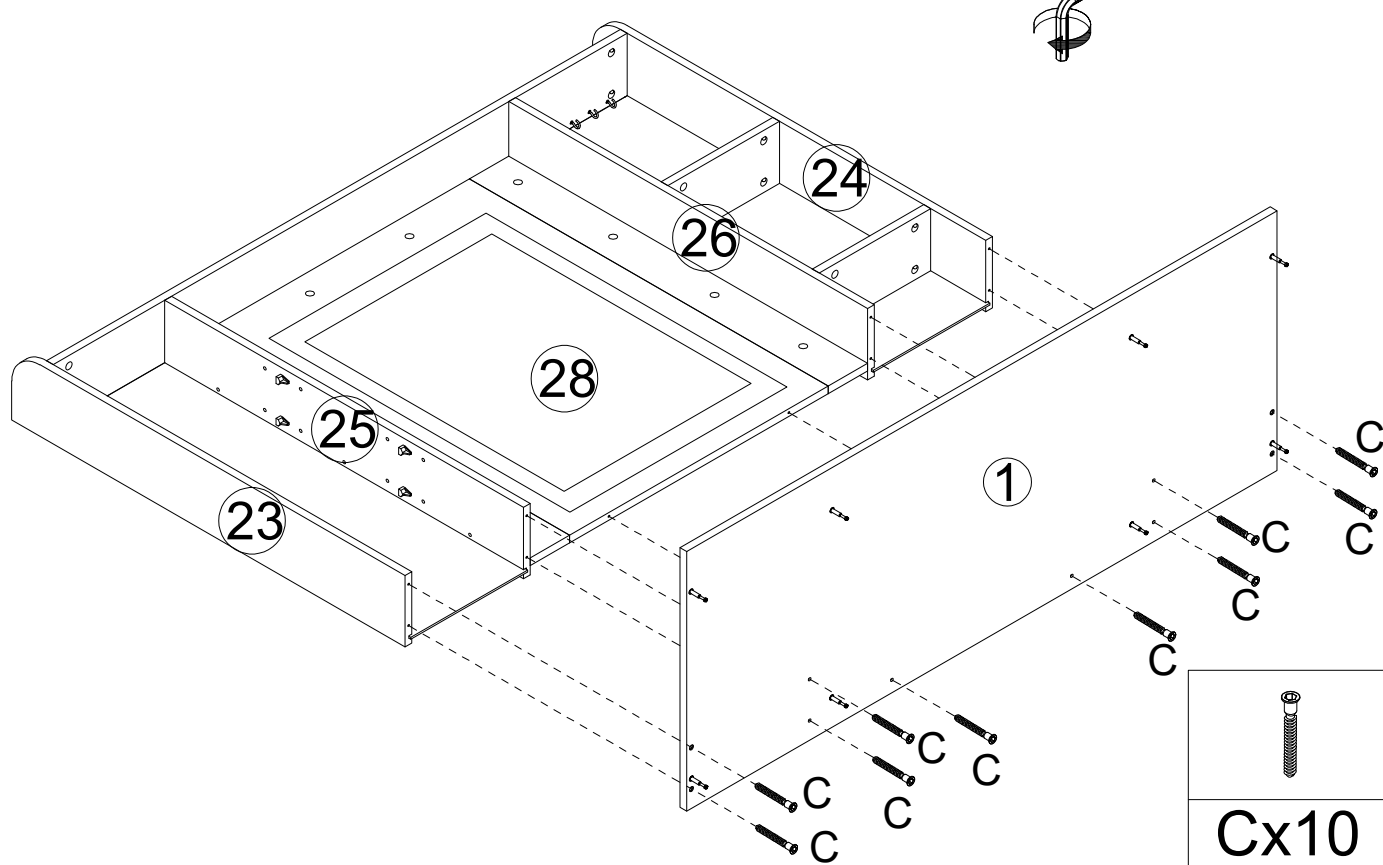
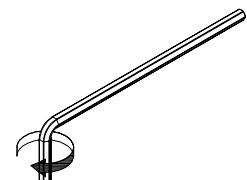



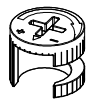
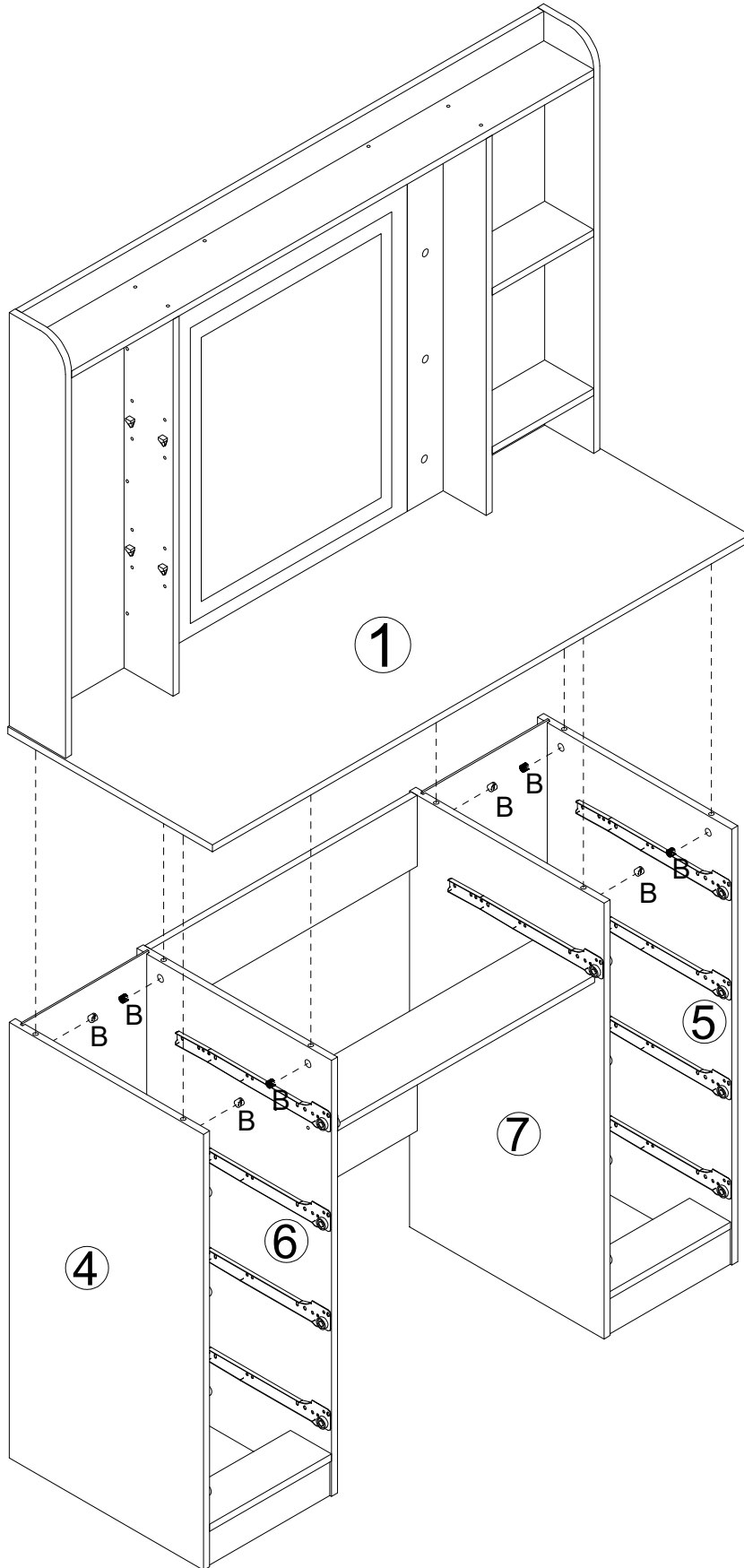
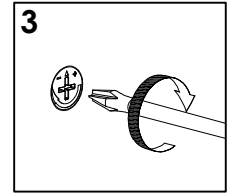
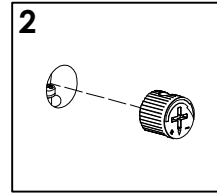
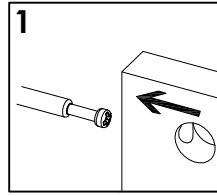
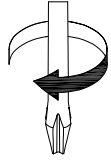

STEP25

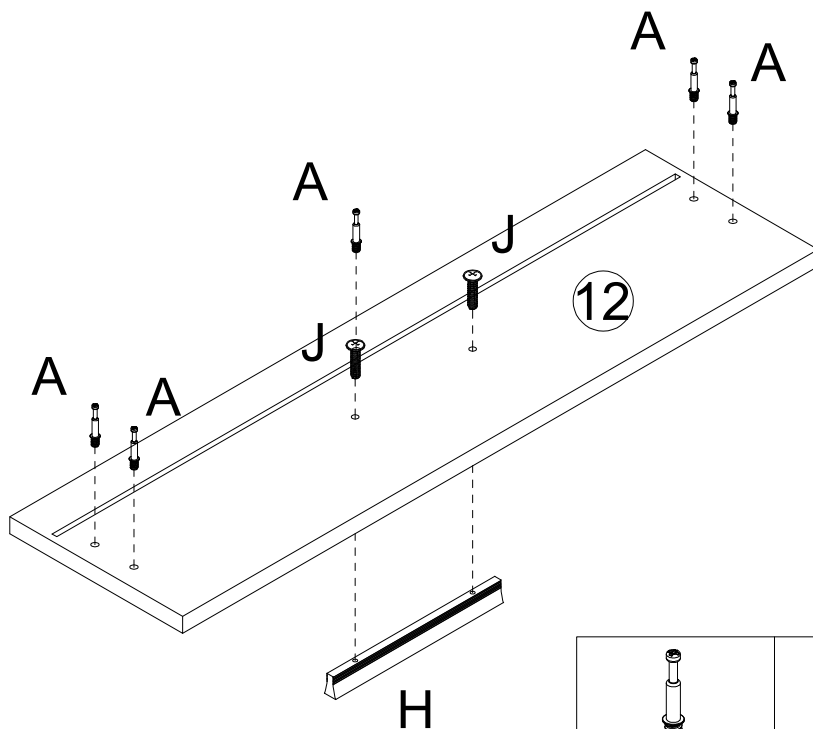
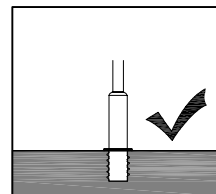
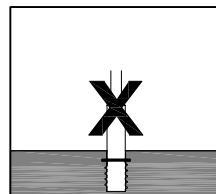
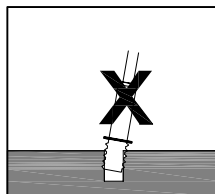
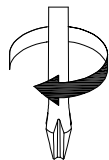

Bx8

STEP26



		
Ax5	Hx1	Jx2

STEP27

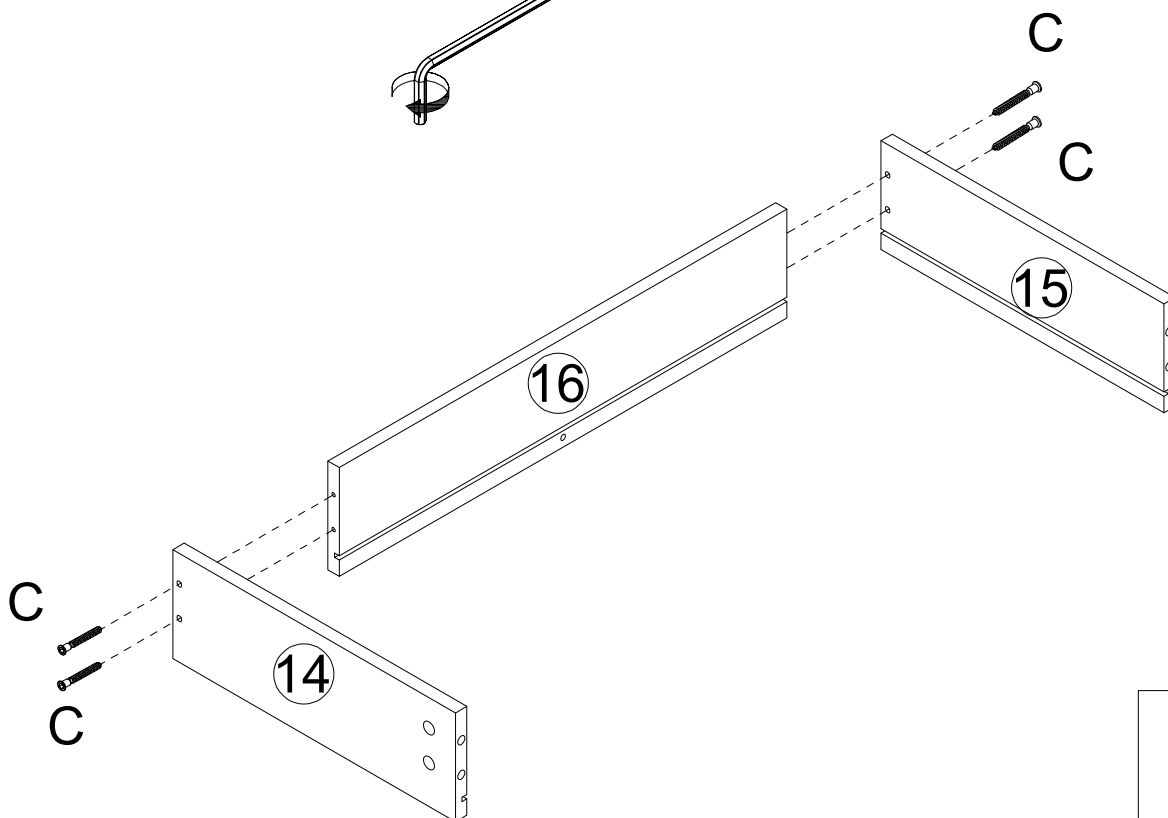
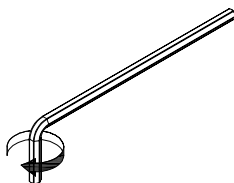

Cx4

STEP28

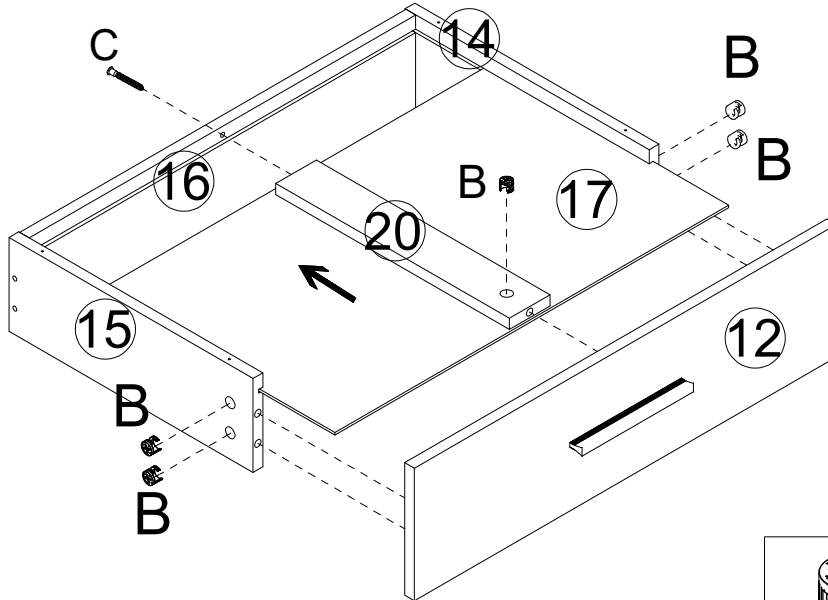
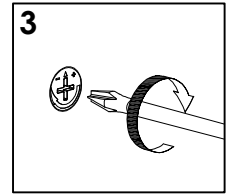
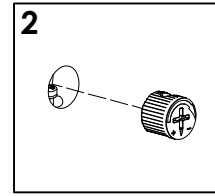
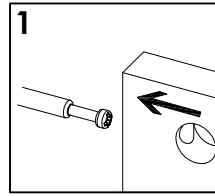
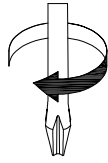

Bx5



Cx1

STEP29

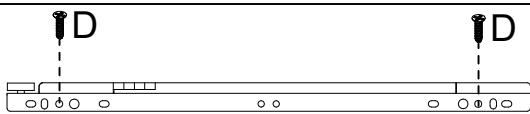
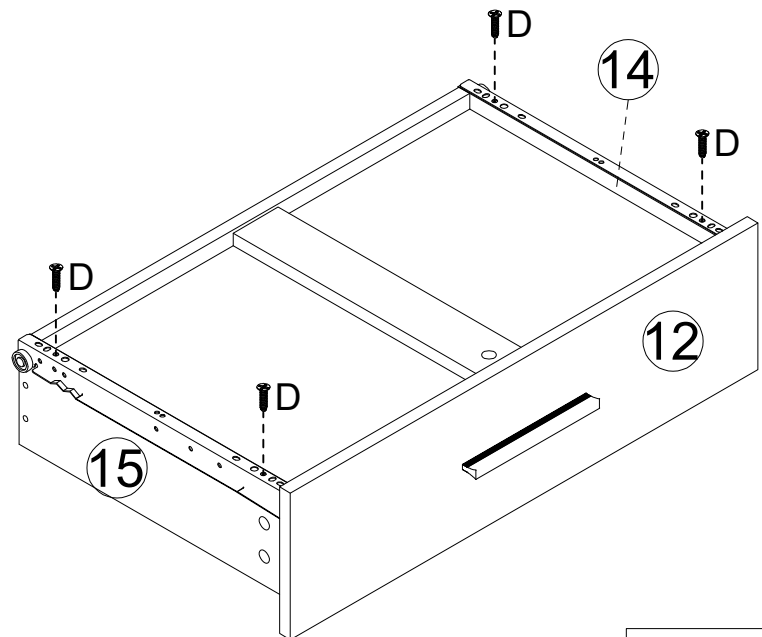
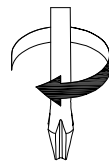

E-DLx1

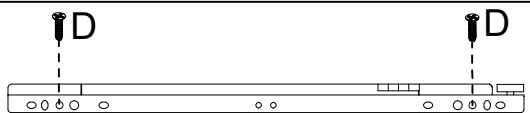





E-DRx1

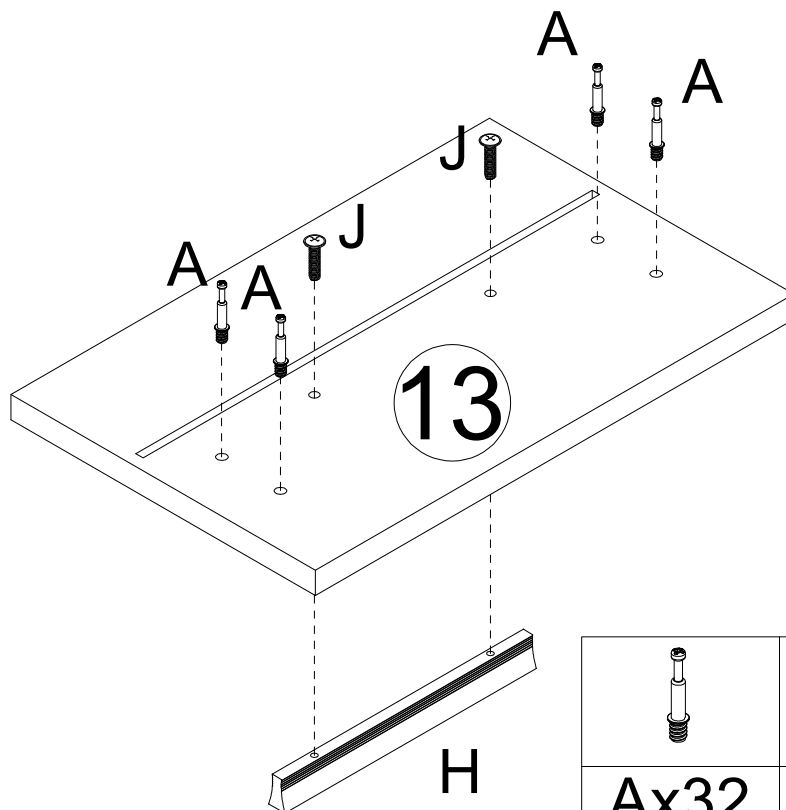
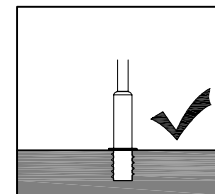
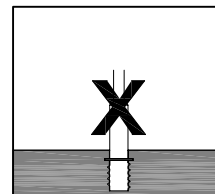
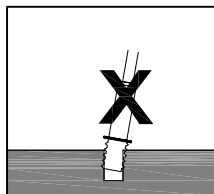
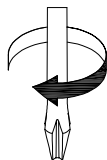

Dx4

STEP30x8



		
Ax32	Hx8	Jx16

STEP31x8

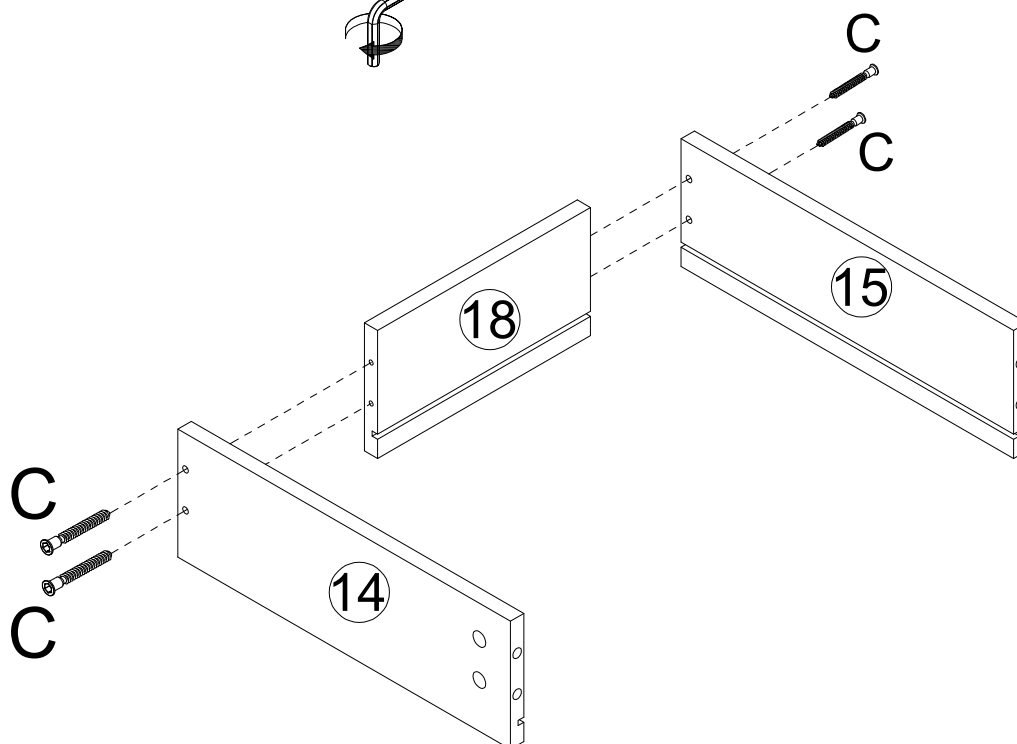
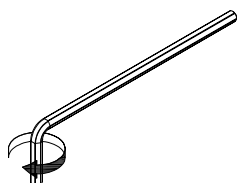

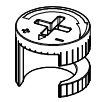
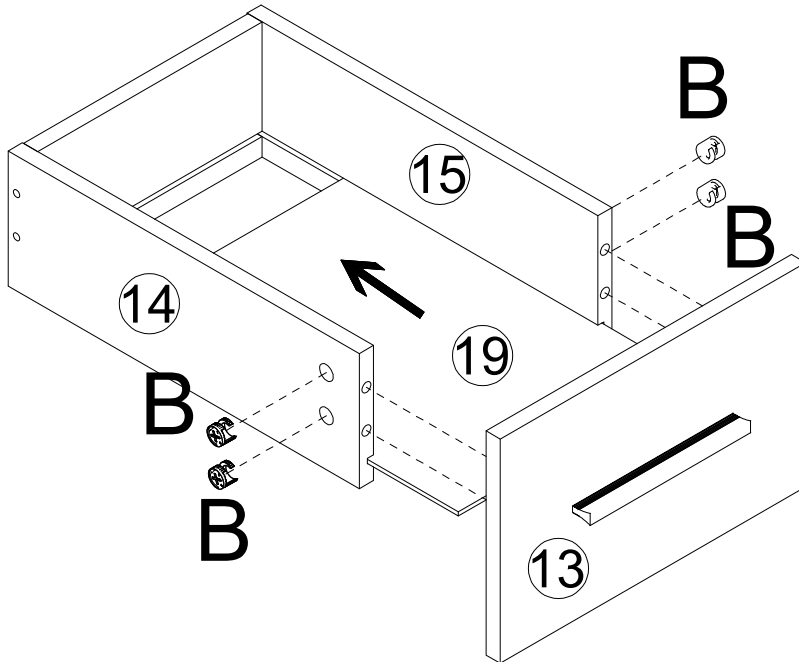
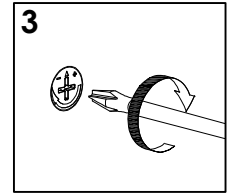
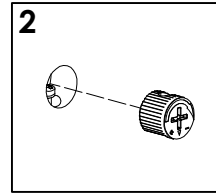
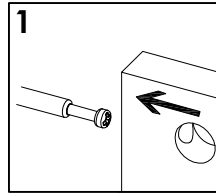
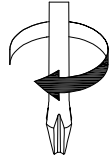

Cx32

STEP32x8

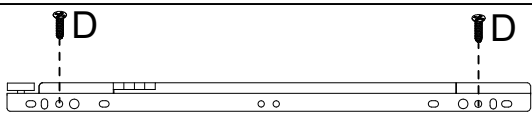
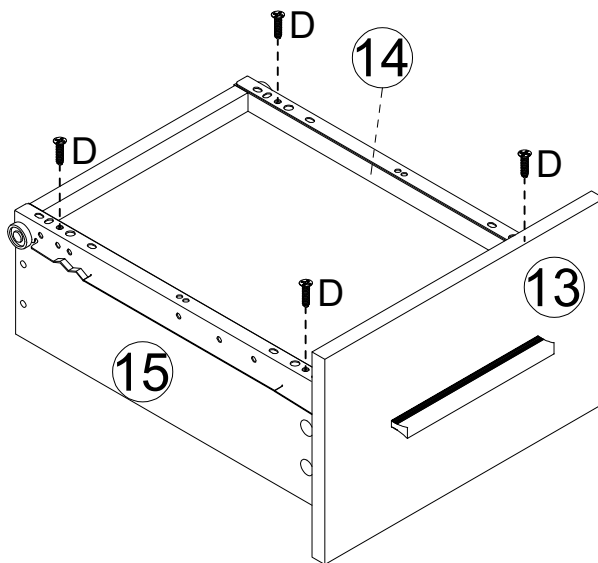
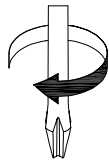

Bx32

STEP33x8



E-DLx8

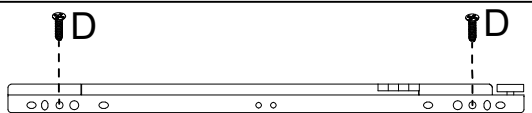

E-DRx8



Dx32

STEP 34

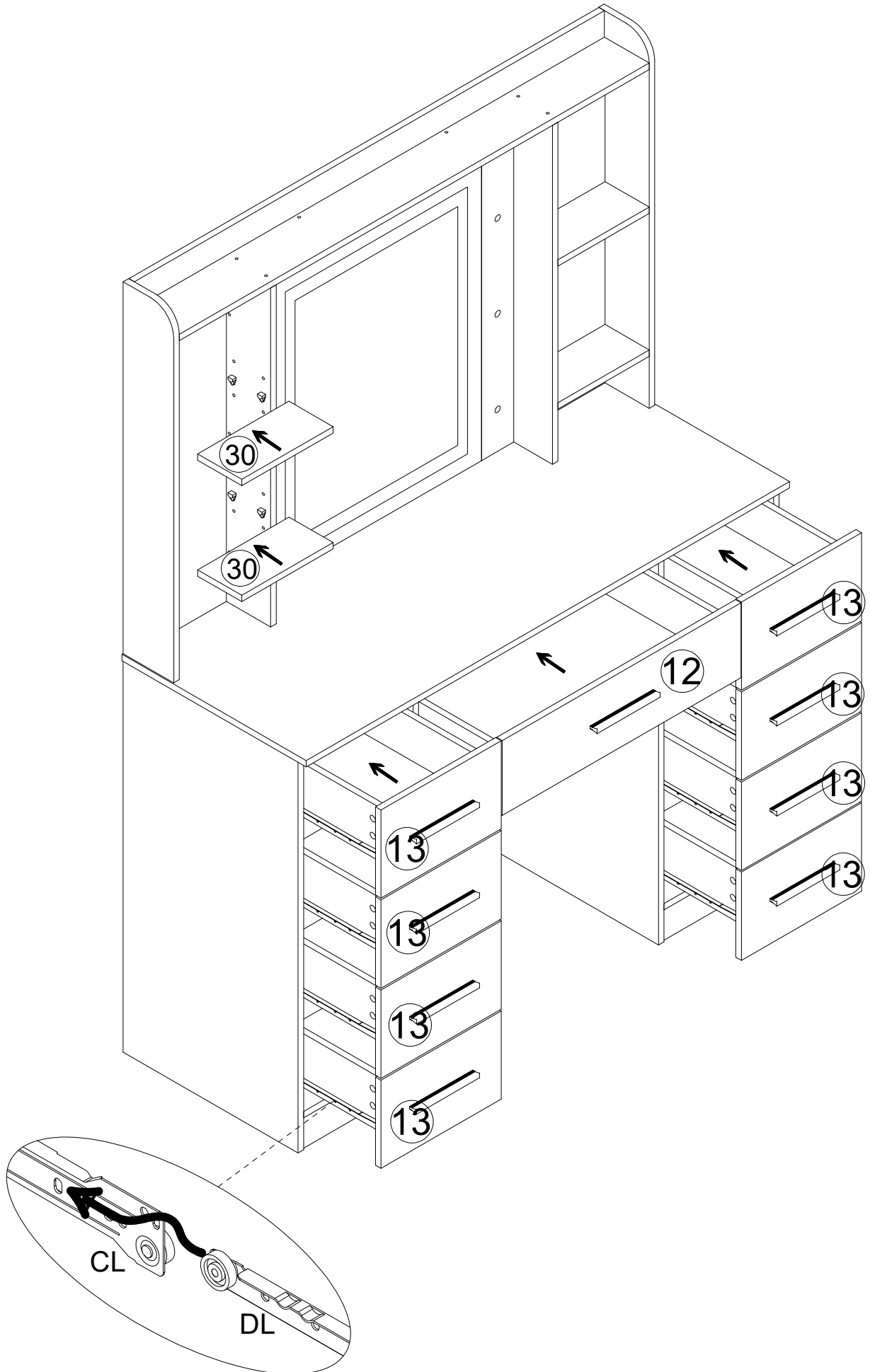

STEP35

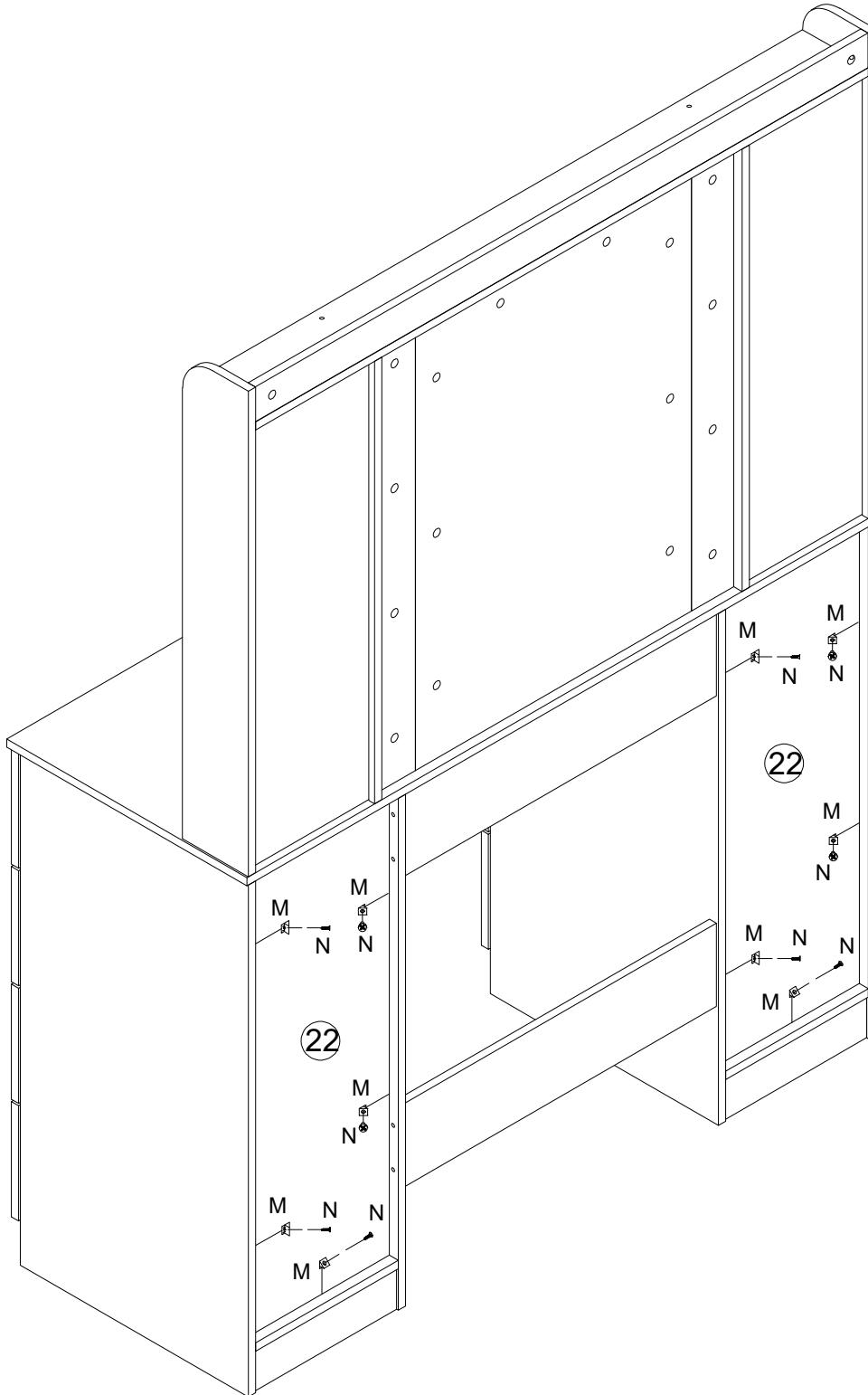
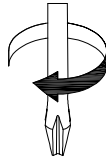

Mx10

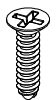

Nx10

STEP36

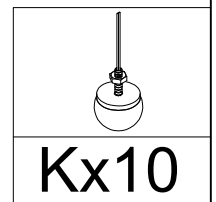
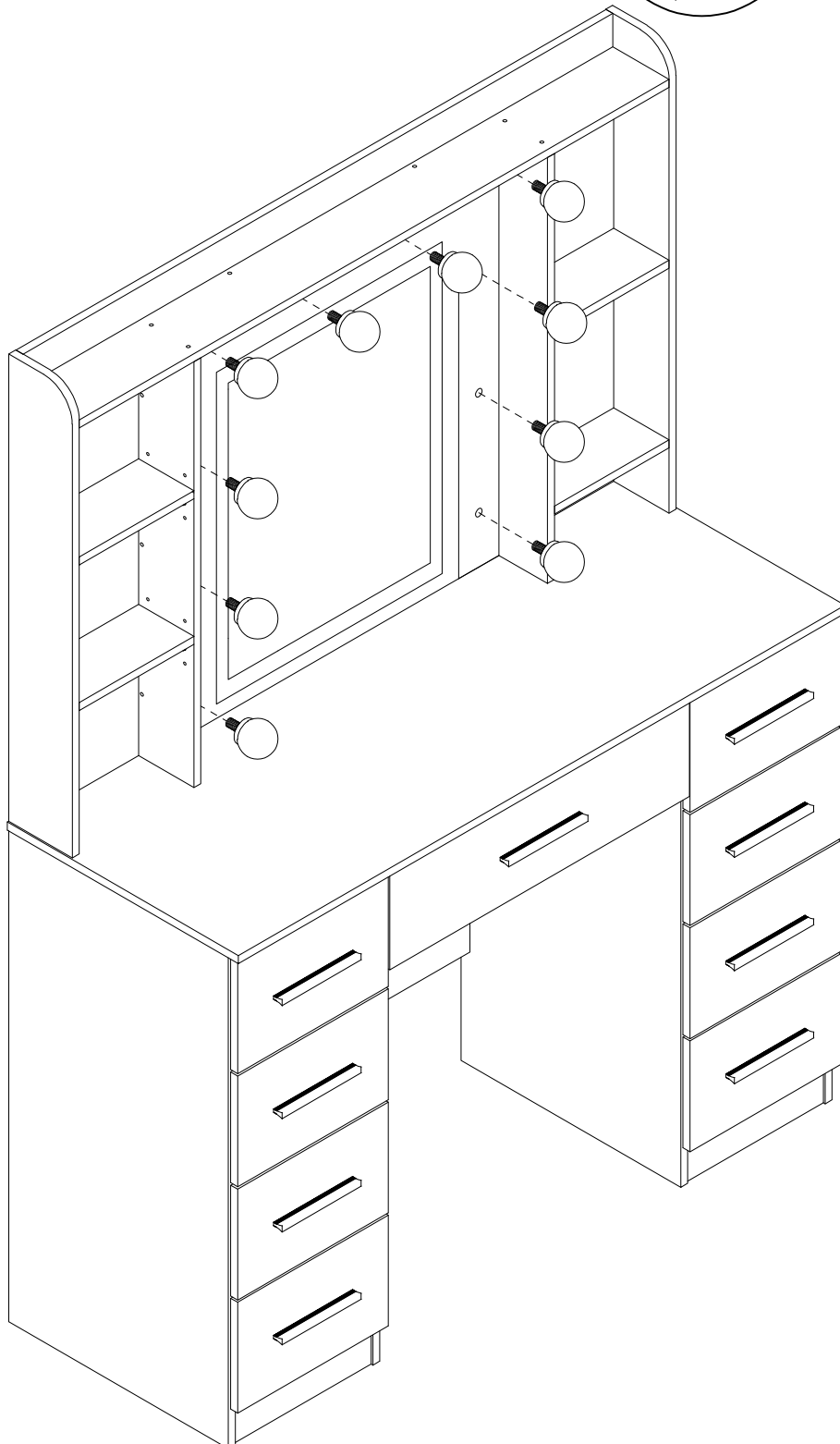
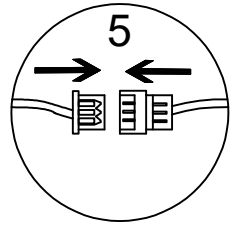
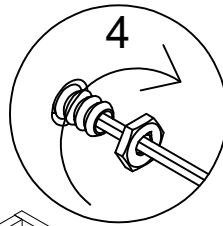
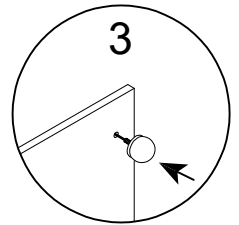
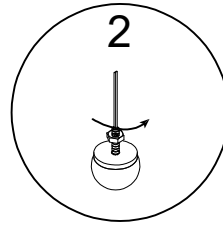
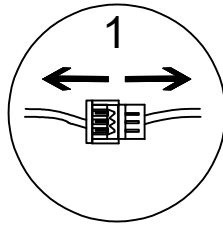

STEP37

