

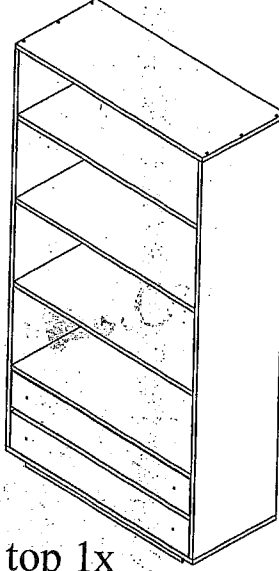
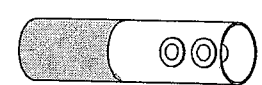
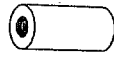
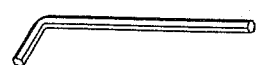

# Assembly instructions:

## SOHO BOOKCASE WITH DRAWER

### 900x380x1800

<p><b>A</b></p>  <p style="text-align: center;">Desk top 1x</p>	<p><b>B</b></p>  <p style="text-align: center;">Cabinet legs (angle) 4x</p>	<p><b>E</b></p>  <p style="text-align: center;">Hand holding drawers <math>\varnothing 11 \times 25 \text{mm}</math> 4x (Tightened inside drawers)</p>
<p><b>C</b></p>  <p style="text-align: center;">Allen key 1x</p>	<p><b>F</b></p>  <p style="text-align: center;">Bolt M4 x 35mm 4x</p>	<p><b>D</b></p>  <p style="text-align: center;">Bolt M8 x 40mm 8x</p>
<p><b>Philips Head Screw driver</b> (Not included)</p>		

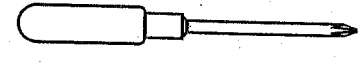
#### STEP 1:

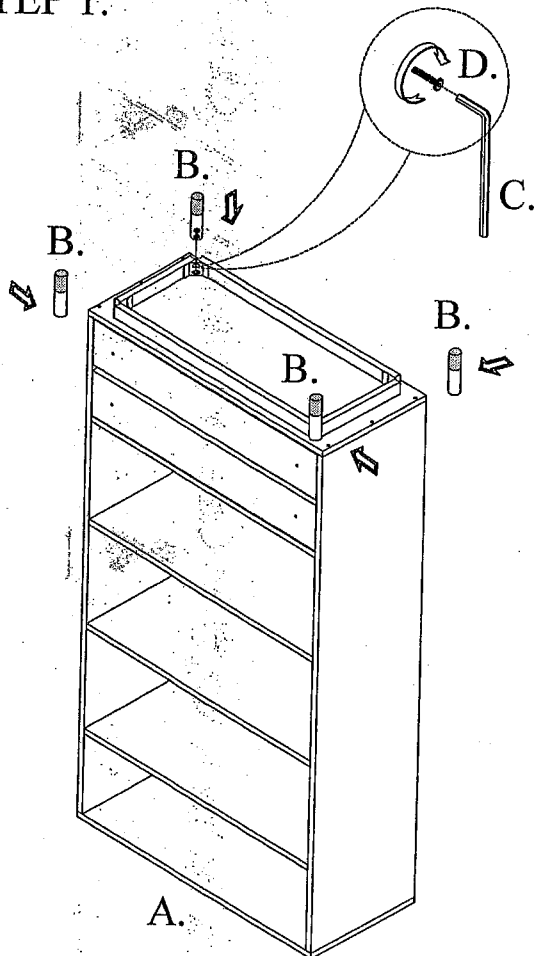

#### STEP 2: Finish.

