







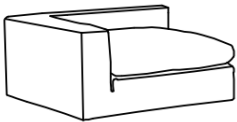

ASSEMBLY INSTRUCTION

CAUTION

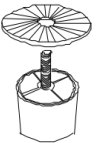
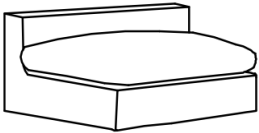

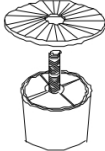
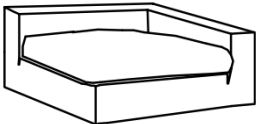
DO NOT use any sharp objects to open plastic wrapped components as this may result damage to product or components .

Your sofa comes packaged in **Four** boxes. Carefully remove all of components from the packaging and set aside for assembly.

Package Contents

BOX 1				
	A*1	B*1	C*1	D*4
BOX 2				
	E*1	F*1	D*4	
BOX 3				
	G*1	B*1	C*1	D*4

Package Contents

BOX 4				
	H*1	D*4		

1 RECLINER ASSEMBLY - BODY SETUP

STEP1:

Install the **Legs (D)** under the **Seat Body (A&E&G&H)** through the plastic washers. Please tighten to fix legs making sure it is securely installed before use.

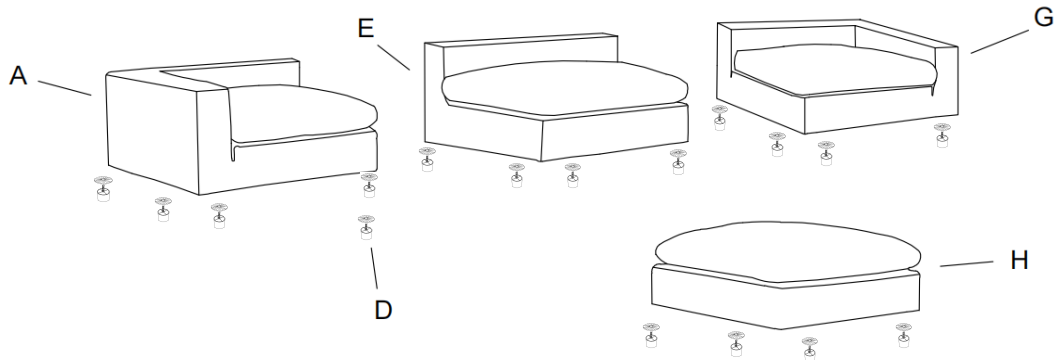

STEP2:

Connect the parts of the sofa assembly by means of the metal clips at the bottom.

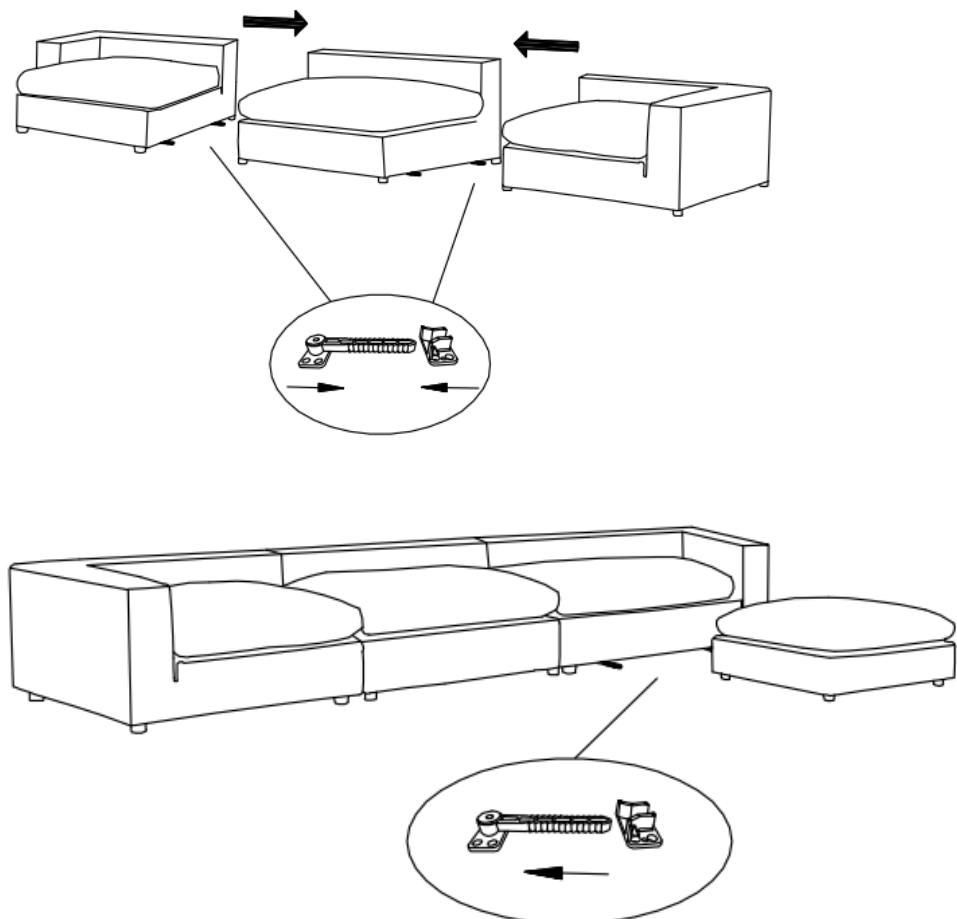

1 RECLINER ASSEMBLY - BODY SETUP

STEP3:

Put pillow(B&C&F) on the sofa. Assembly is complete.

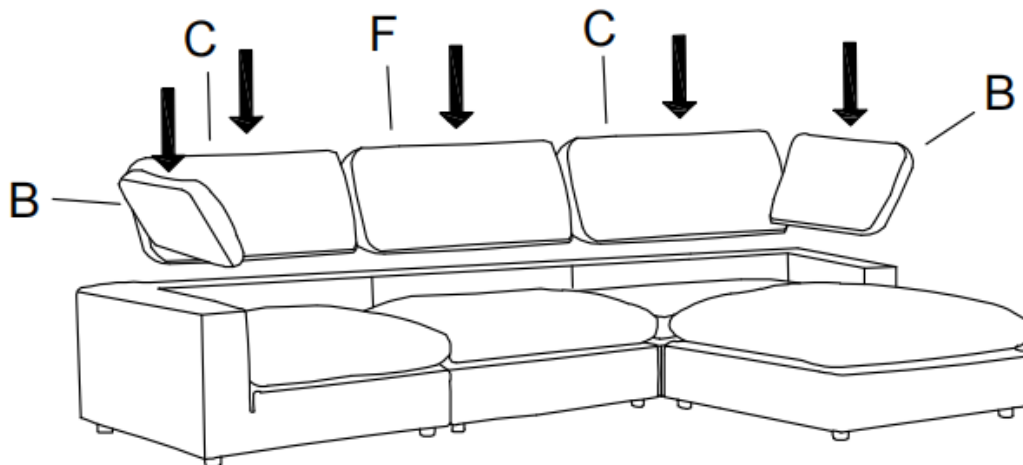

ASSEMBLY COMPLETED

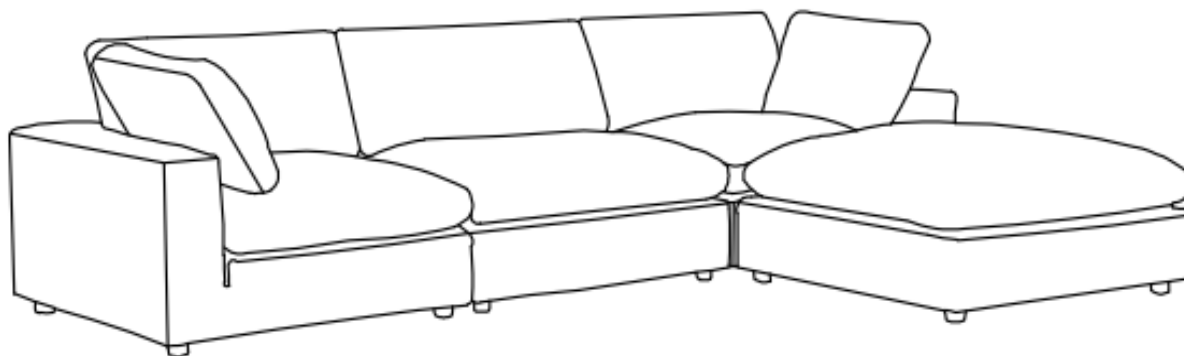

3 INSTRUCTIONS FOR USE - SIZE DIMENSIONS

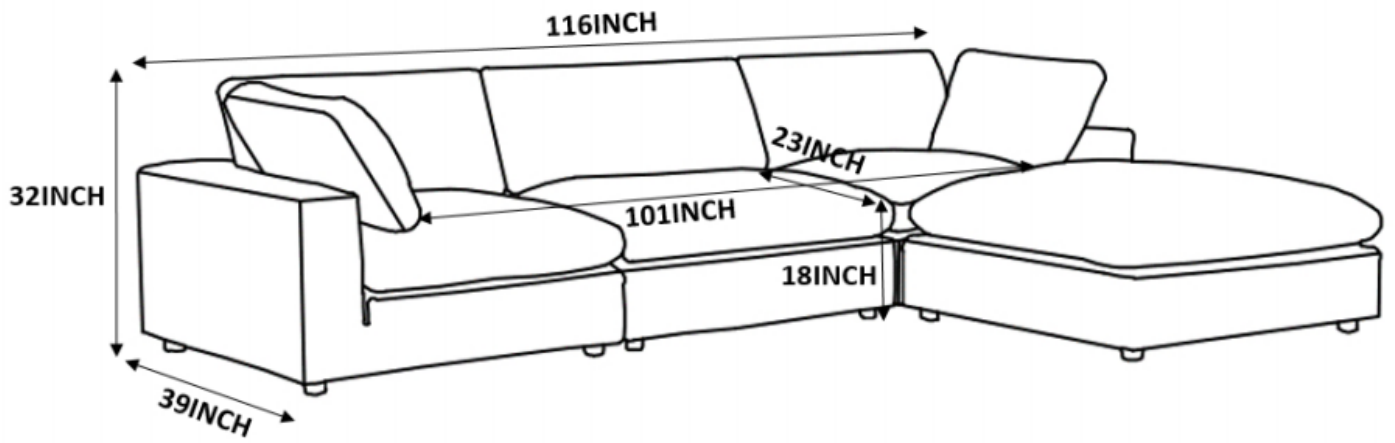

⚠️ WARNINGS

1. Please check if the components of the chair are all included and can be used normally.
2. Assemble all components according to the instruction correctly before you connect the chair to the power.
3. Please DO NOT sit on the armrests or footrest to eliminate the risk of tipping over.
4. If the chair is damaged or doesn't match the website description, please send clear pictures of the product and label of the carton to our service team for further help.
5. If the recliner doesn't work, you may try the following measures for self-checking firstly:
 - a) check if all the cables are connected;
 - b) check if the light of transformer is on.

If the chair still doesn't work, please feed the information back to our customer service in time and we will help you solve the matter as soon as possible.

