

Installation Instruction

FOR PENDENT LAMP

WARNING SHUT POWER OFF AT FUSE OR CIRCUIT BREAKER

SWH-CDL-OK101

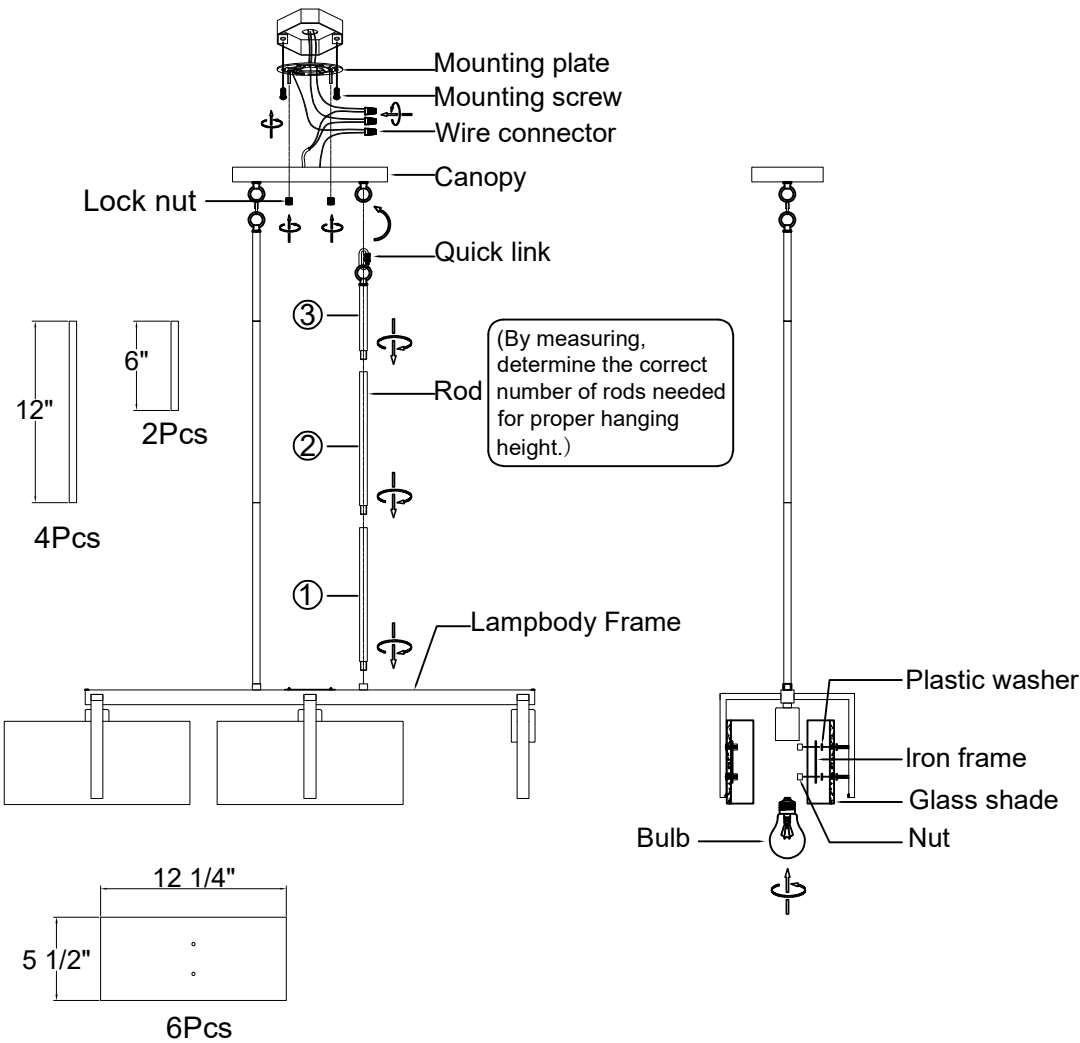

Please completely comply with this instructions and notes to ensure that the product is operated in a safe condition.

1

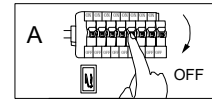

Turn off the power

2

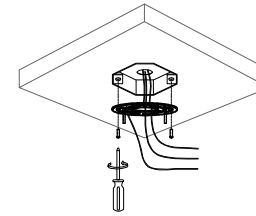

Install of bracket and side screws

3

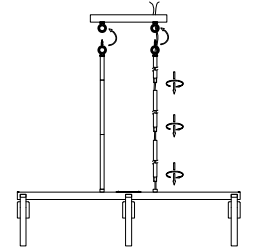

Pass fixture wires and ground wire through rod ①②③/canopy/ then screw the rods one by one together onto the top of lampbody frame, finally attach the quick link to canopy.

4

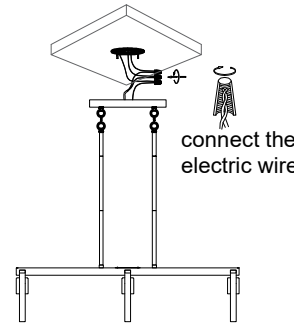

connect the electric wire

5

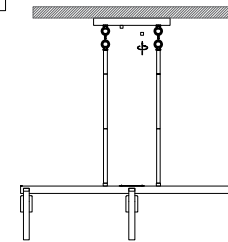

Attach the canopy to mounting plate by screwing lock nut.

6

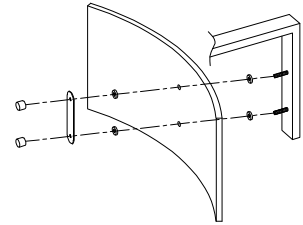

Assemble glass: Pass through the plastic washer-glass-another plastic washer-iron frame to the screw, Secure them with nut to tighten the glass.

7

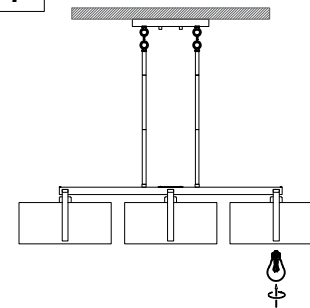

Install bulbs (not included)

8

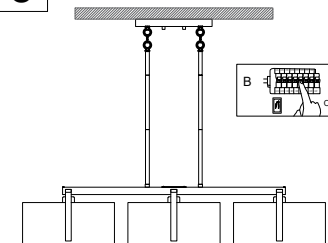

Finish installation