



ASSEMBLING INSTRUCTION

⚠ Please read the instructions care fully before start insatllation



Suggested tools for assembling

Wrench

Screw driver

Drill



Measurement tape

Before start assembling

- Safety first
- Turn off power
- Use proper tools
- Check for damage
- Follow the instructions
- Keep the product dry
- Don't work alone
- Seek professional help

WARNING !!!
 Before proceeding make sure the electricity is switchd off at the main supply

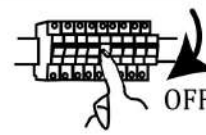
Basic installation Instructions



Make sure to turn off the power source to the circuit you will be working on. Locate the circuit breaker or fusebox and turn off the switch or remove the fuse that controls the circuit.

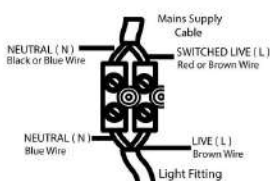

Use wire connectors for safty connection. Wire connectors are a common and important electromechanical component. Connectors can join to

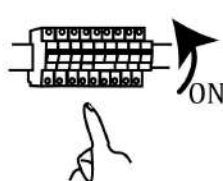









Dont forget to restore the power supply after the full installation

Continue to next page for the product Assembling →

WARNING !!!
 Before proceeding make sure the electricity is switchd off at the main supply

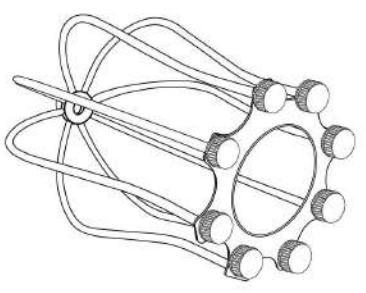
ACCESSORIES FIGURE

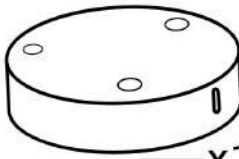
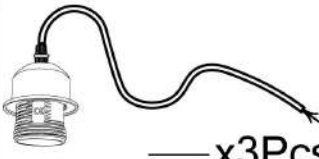
	x1Pcs	A		— x3Pcs	G
	x2Pcs	B		— x3Pcs	H
	— x2Pcs	C		— x1Pcs	I
	— x2Pcs	D	 — x3Pcs K		
	— x3Pcs	E			
	— x3Pcs	F			
 — x1Pcs J			 — x3Pcs L		

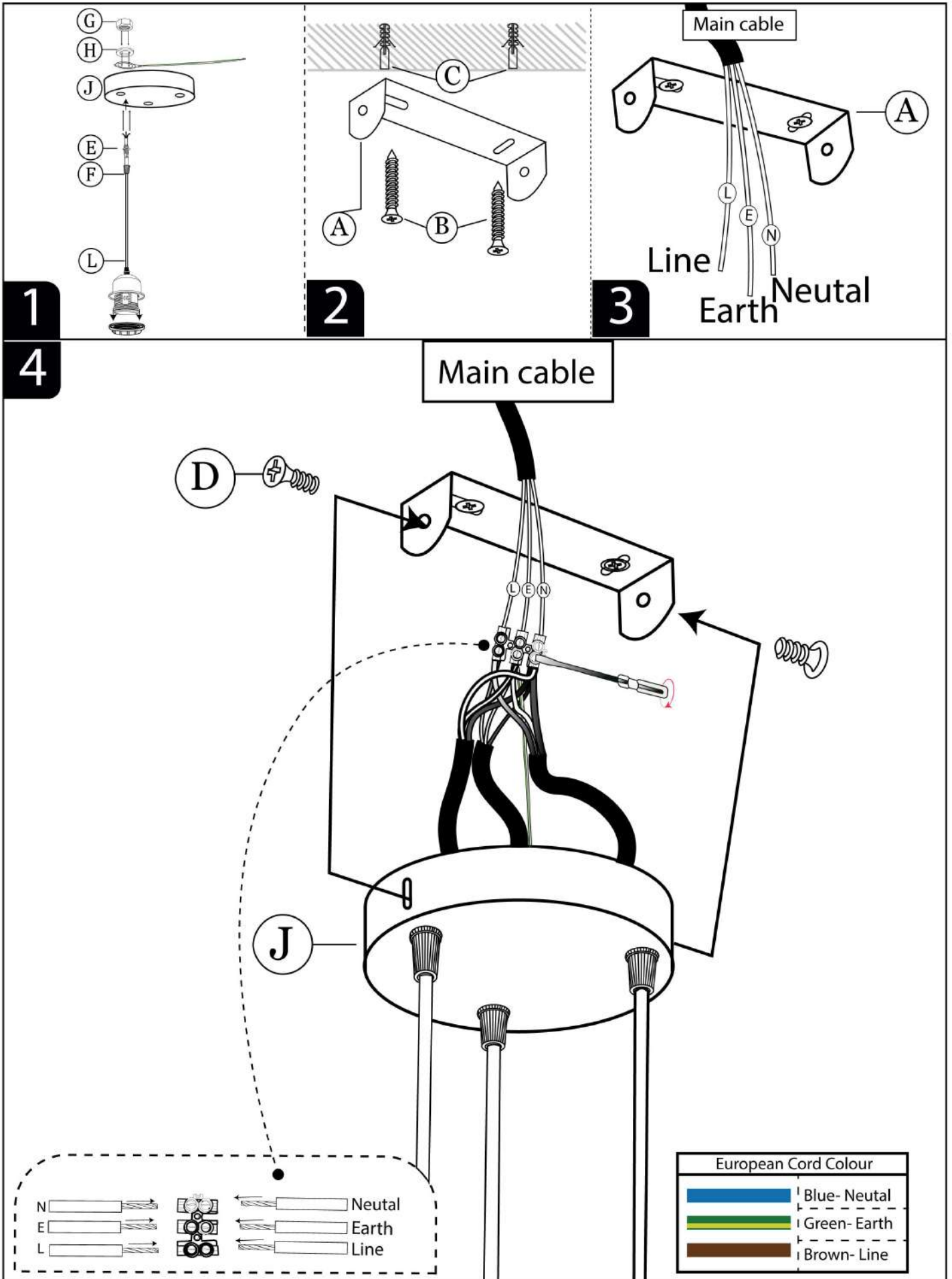

1

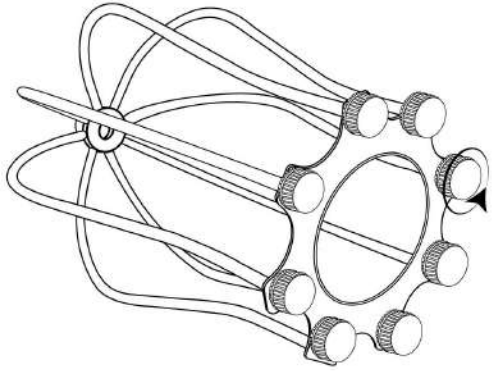

2

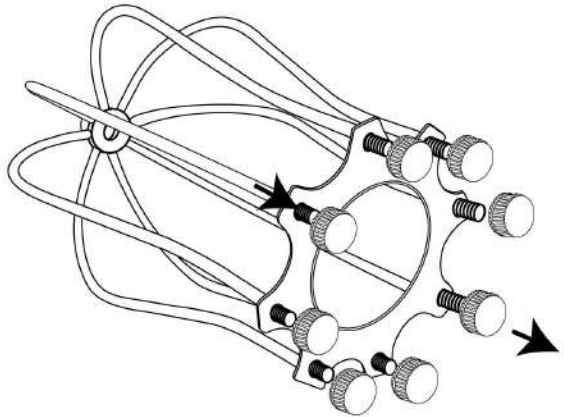

3

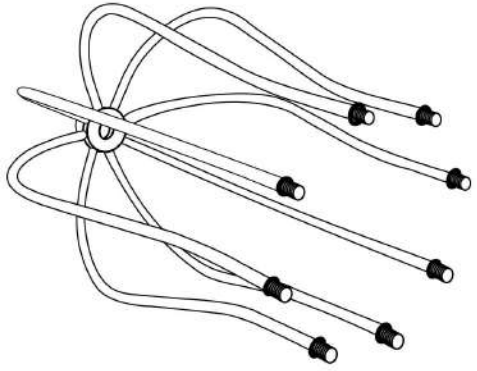

4

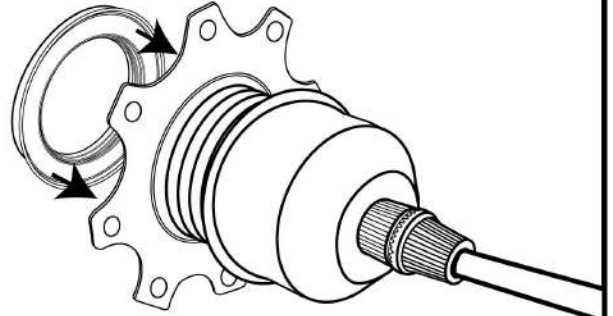

5

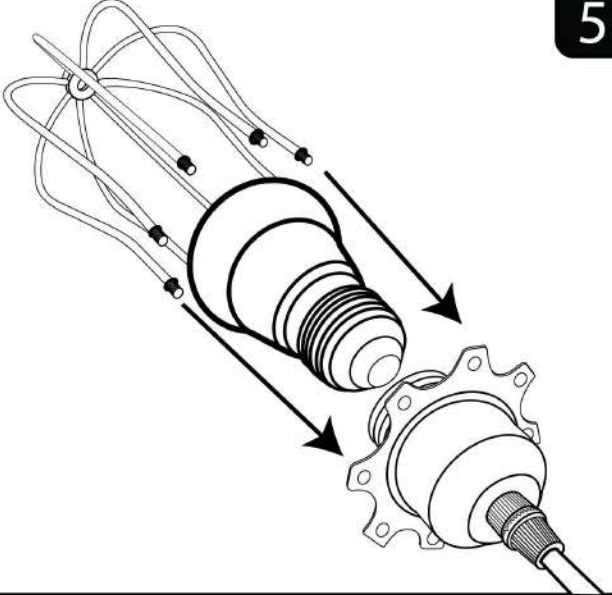

6

