

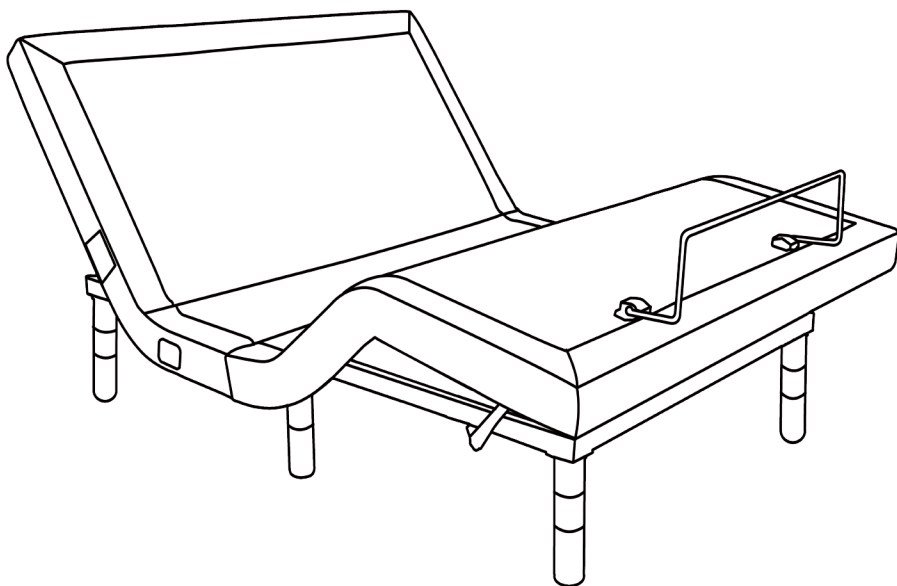





# Manual Instructions

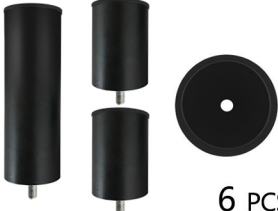

# Spare Parts

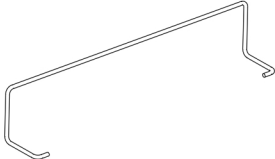
<b>A</b>  1 PC	<b>B</b>  6 PCS	<b>C</b>  2 PCS
The bed body	Legs and Washers	Middle leg fasteners
<b>D</b>  1 PC	<b>E</b>  1 PC	<b>F</b>  1 PC
Mattress stopper	Adaptor	Handset

# Spare Parts

Please check the packing list while unpacking the box to ensure you received all necessary parts for assembling the bed base.

Should you find any parts of the bed base missing while unpacking, please email us. We will get back to you within 48 hours.

As you unpack and prepare for assembly, place the contents on a carpeted or padded area to protect them from damage.



# Assembly Instructions

1

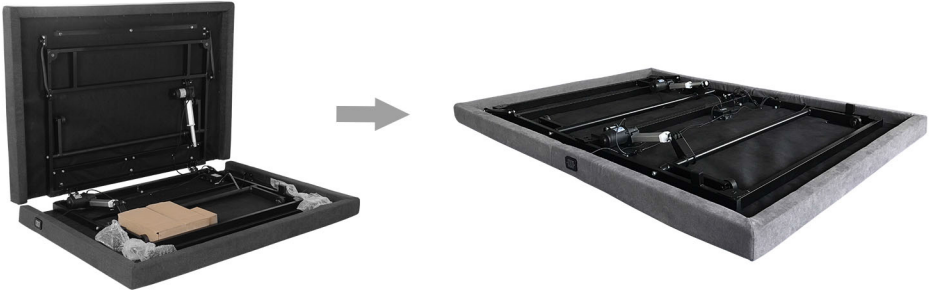

Unfold the base to full extension.

2

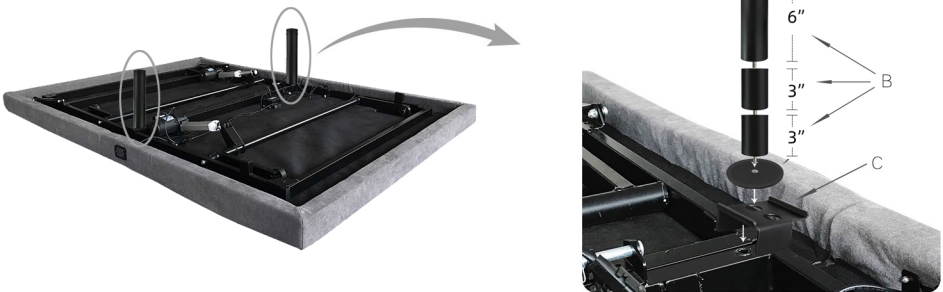

Put middle leg fastener into position C to prevent the base from folding while in motion. Attach the middle legs respectively.

3

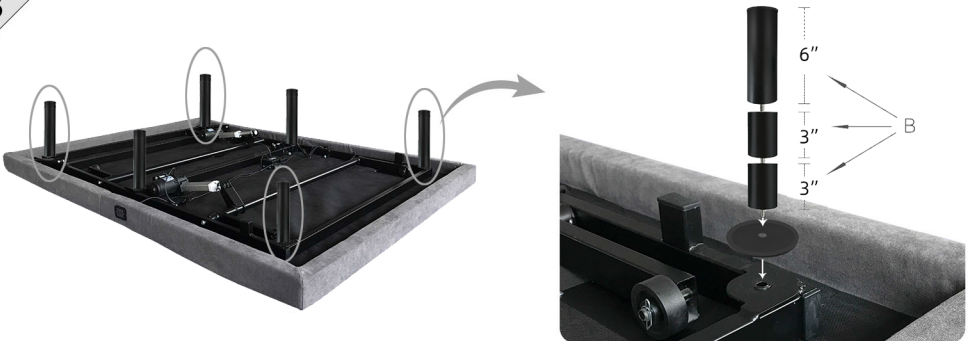

Install each of the four corner legs respectively.

# Assembly Instructions

4

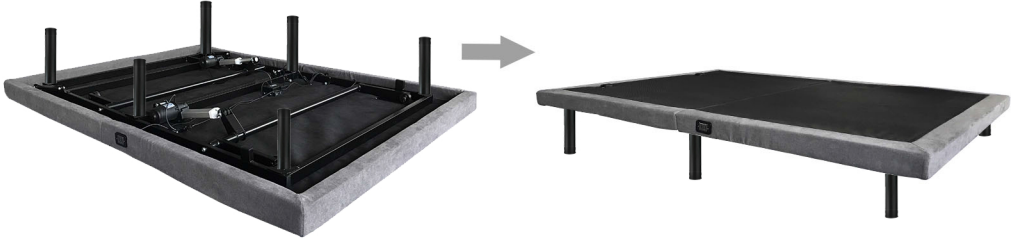

Flip the base over.

5

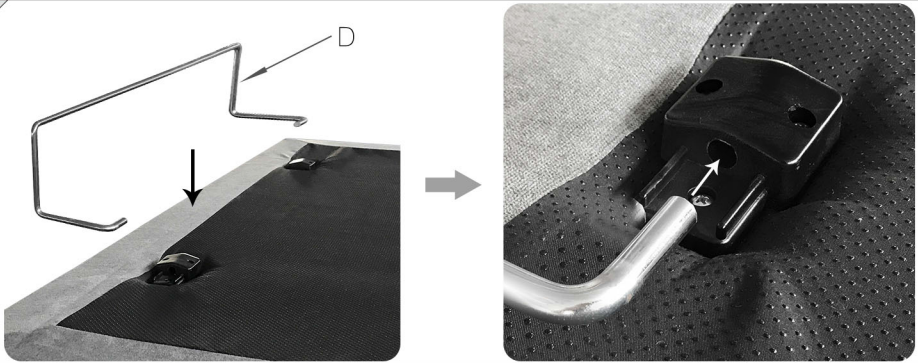

Put the foot retainer on and connect to adaptor.

6



Please check to make sure that all support arms are in the right place and stable.

# Wiring Diagram

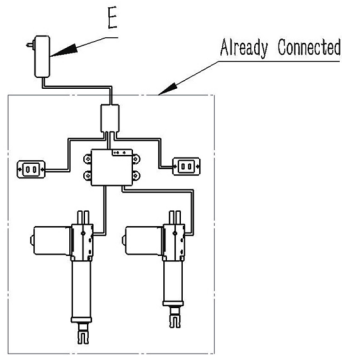

Customers only need to connect the adaptor(E). All other wires are already connected.

# Warning

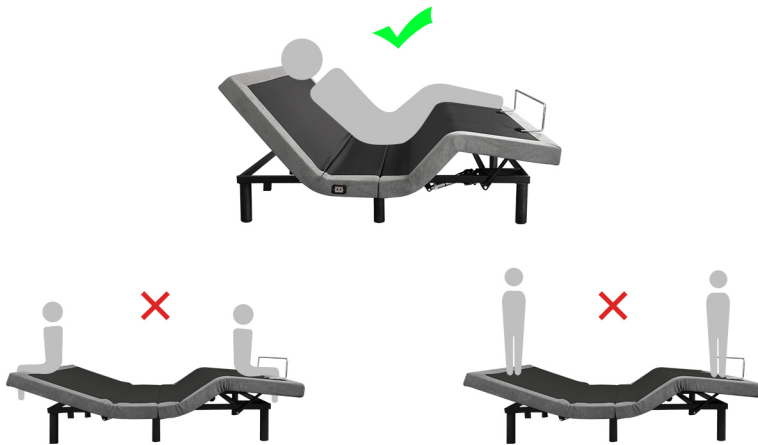

The weight should be evenly distributed across the bed base during the operation of the bed base. Any misconduct, such as sitting/standing on the head or foot section of the bed, as well as jumping off the bed is extremely prohibited!  
Customers who fail to obey the warning will be responsible for the damage or malfunction of the bed base, and said damage will not be covered by our warranty.

# Instruction Manual of Remote Control System

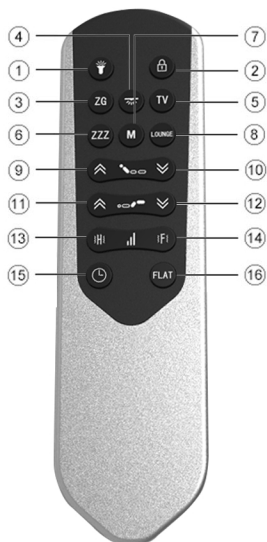

The remote control uses 3pcs 03AAA SIZE 1.5V batteries.

① Flashlight :	Click this button and flashlight will turn on the bright white light. Click this button again and it will turn off. If not , it will be turned off automatically after 3 seconds.
② Lock Button :	To lock the remote press and hold the lock button for 3 seconds.A red light will show. To unlock the remote,press the lock button and hold it again for 3 seconds.The red LED light will turn off and the other lights will turn on indicating that the remote control has been unlocked.Please note that the lock button does not affect the function of the flashlight or background light.
③ Zero Gravity :	Pressing this button will bring the bed base to the preset ZG position(For relaxing purpose after a long day work or study ). The adjustment process can be interrupted by pressing any other buttons.
④ Under -bed light :	Press the under-bed light to turn on or turn off the under-bed light. Default timing is 1 hour.
⑤ TV position :	Pressing this button will bring the bed base to the preset TV position(Comfortable for watching TV or using your laptop). The adjustment process can be interrupted by pressing any other buttons.
⑦ Flat :	Long press the head button to adjust the head section of the bed base up.
⑥ ⑧ Memory position M1&M2 :	To set the bed to one of your favorite positions,find the position and then press and hold the Foot UP &Foot DOWN buttons for 3 seconds.The LED light will flash for 6 seconds. During this period, press one memory button and the light will stop flashing and turn off after 3 seconds.This position is now memorized.
⑨ Head up :	Long press the head button to adjust the head section of the bed base up.
⑩ Head down :	Long press the head button to adjust the head section of the bed base down
⑪ Foot up :	Long press the Foot button to adjust the foot section of the bed base up
⑫ Foot down :	Long press the Foot button to adjust the foot section of the bed base down

⑬ Head massage ON/OFF Button :	Press the massage button to turn the head massage motor on or off
⑭ Foot massage ON/OFF Button :	Press the massage button to turn the foot massage motor on or off
⑮ Massage time :	Press the Massage Time button to choose the massage time. A blue light indicate 10 minutes; Green light 20 minutes; red light 30 minutes.
⑯ Massage mode :	Press the Massage Mode button to choose the massage mode to change the vibrating intensity of head and foot motors .there are 3 levels of intensity for you.

## Reset Instruction

The TV/ZG position can be reset to your preference. Refer to the following steps to reset the TV/ZG position.

- 1 Adjust the bed base to your preferred head & foot position.
- 2 Long press ⑪ and ⑫ button for 3 seconds. The background light will flicker.
- 3 Press any memory button within 6 seconds to stop the flicker.
- 4 At the same time, press ⑪ and ⑫ button on the foot. The light will flash for 6 seconds to restore the initial position.

## Remote Matching Instruction

The following are the particular situations where it is necessary to go through the matching process.

1. Customers who own two or more adjustable beds in the same room.
2. Customers who wish to control adjustable beds with different remote.

- 1 Connect the bed base to power supply (within two minutes).
- 2 At the same time, press ⑨ and ⑩ button for 3 seconds, and the background light will start flashing. The flashing time 3 seconds, which indicates that the code matching is complete.

## Convenient “Flat button”

- 1 Long press the “Flat button” on the control box until the bed base goes down to flat position.
- 2 During the reset process, release the button and the operation stops; Press the reset button again to continue the reset action.

Power supply: connect DC 29V DC power supply



## Cleaning & Care

Clean surfaces with a dry or damp soft cloth. Make sure the motor control system is well connected before use.  
Please cut off the power if the bed base will not be in use for long periods of time.