

NOTICE

- * Please make sure that you have all parts indicated and they are in good condition before you begin assembly of this item. Refer to part list and hardware list below for guidance.
- * This item should be assembled on a soft surface to prevent scratching the finish during assembly.
- * This item may require periodic tightening.





PREPARATION

- * Before beginning assembly of product, make sure all parts are present. Compare parts with part contents list and hardware contents list.
- * If any part is missing or damaged, do not attempt to assemble the product.
- * Estimated Assembly Time: 10 minutes.

CARE AND MAINTENANCE

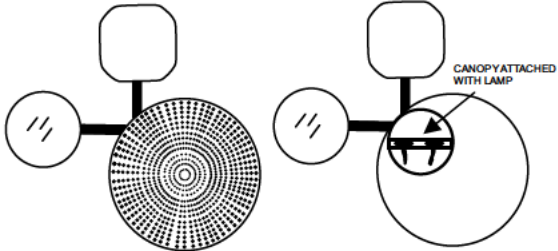
- * Before cleaning any lampshade or fixture, disconnect the power source.
- * Wipe with damp cloth. Avoid the use of chemical and household cleaners as they may damage the finish.

Part List and Hardware List

PIECE	DESCRIPTION	PICTURE	QUANTITY
A	LAMP		1X
H1	Mid Screw (7x7x13 mm)		2X
H2	Plastic Screw Anchor		2X
H3	Long Screw (8x8x600 mm)		2X
H4	P2 (Wire Connector)		3X

PRODUCT DIMENSION - 17"W X 4"D X 16"H

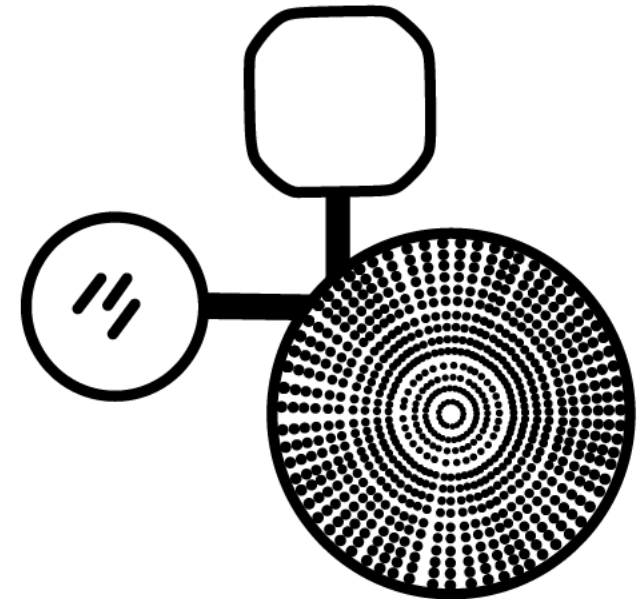

 60 watt max type A bulb (NOT INCLUDED)
OR
9 watt max LED bulb (NOT INCLUDED)

PREPARATION

- * Shut off the main electrical supply from the main fuse box/circuit breaker.
- * Carefully unpack all fixture parts and hardware. Lay items out on a clear workspace.
- * Place the mounting plate over the center of the ceiling junction box. Align holes in mounting with holes in junction box & attach with 2 mounting screws.
- * Gently pull wiring down from the ceiling junction box and allow it to hang.
- * Fit canopy onto mounting plate and secure with 2 canopy screws.

CANOPY ASSEMBLY

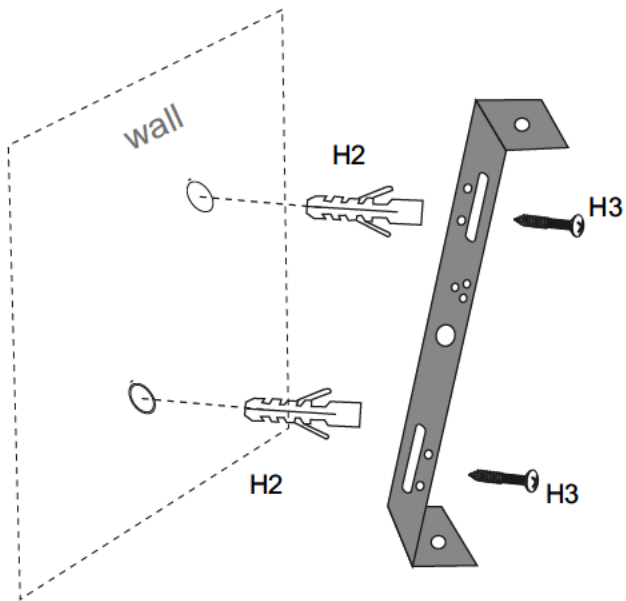

Step 1 Use H2 into wall & fix the canopy strip into wall with the help of long screw H3.

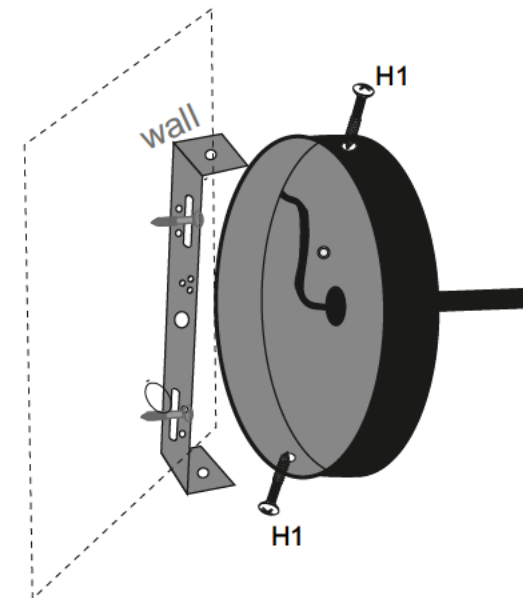

Step 2 Align the canopy side hole with strip hole & fix it by using small screws H1 and tighten the same.