

Furinno Sun Lounger With Tray

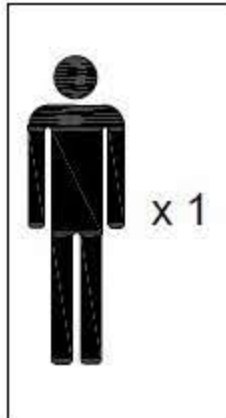

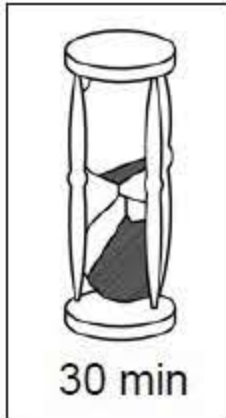







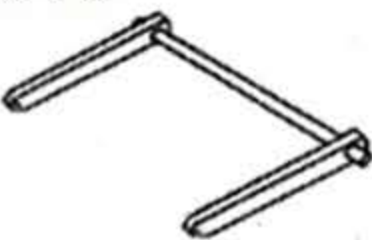

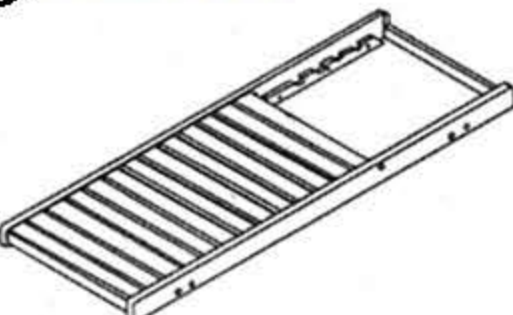













CARE INSTRUCTION:

This Furniture was treated with teak oil at the factory. To maintain the original appearance, you need to treat with a suitable wood oil at least once a year. Left untreated, the wood will weather to a silvery grey.

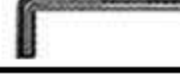
As timber is a living product you may find that you need to periodically tighten any fittings.

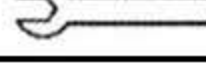
Covering or storing your furniture to protect it from ice and snow will keep it looking even better for even longer!

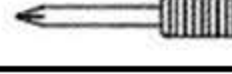
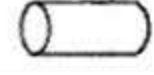
A Back Rest x1 Pc 	B Back Rest Support x1 Pc 	K  M8 x 60mm JCBB 2 PCS
C Seat x1 Pc 	D Tray Glide x2 Pcs 	L  M6 x 60mm JCBC 6 PCS
E Tray x1 Pc 	F Front Leg x2 Pcs 	M  M6 x 35mm JCBC 4 PCS
G Front Leg Bar x1 Pc (LONG) 	H Back Leg x2 Pcs 	N  M6 x 25mm JCBC 4 PCS
I Back Leg Bar x1 Pc (SHORT) 	J Wheel x2 Pcs 	O  M6 x 50mm JCBC 6 PCS
		P  M6 BARREL NUT 4 PCS
		Q  M6 LOCK NUT 4 PCS
		R  M8 LOCK NUT 2 PCS
		S  M8 x 18mm FLAT WASHER 4 PCS
		T  M6 x 18mm FLAT WASHER 6 PCS
		U  M8 x 18mm PLASTIC WASHER 4 PCS
		V  M4 ALLEN KEY 1 PC
		V.I  M5 ALLEN KEY 1 PC
		W  10MM SPANNER 1 PC
		X  13MM SPANNER 1 PC
		Y  MINI SCREW BIT 1 PC
		Z  M8 METAL TUBE 2 PCS

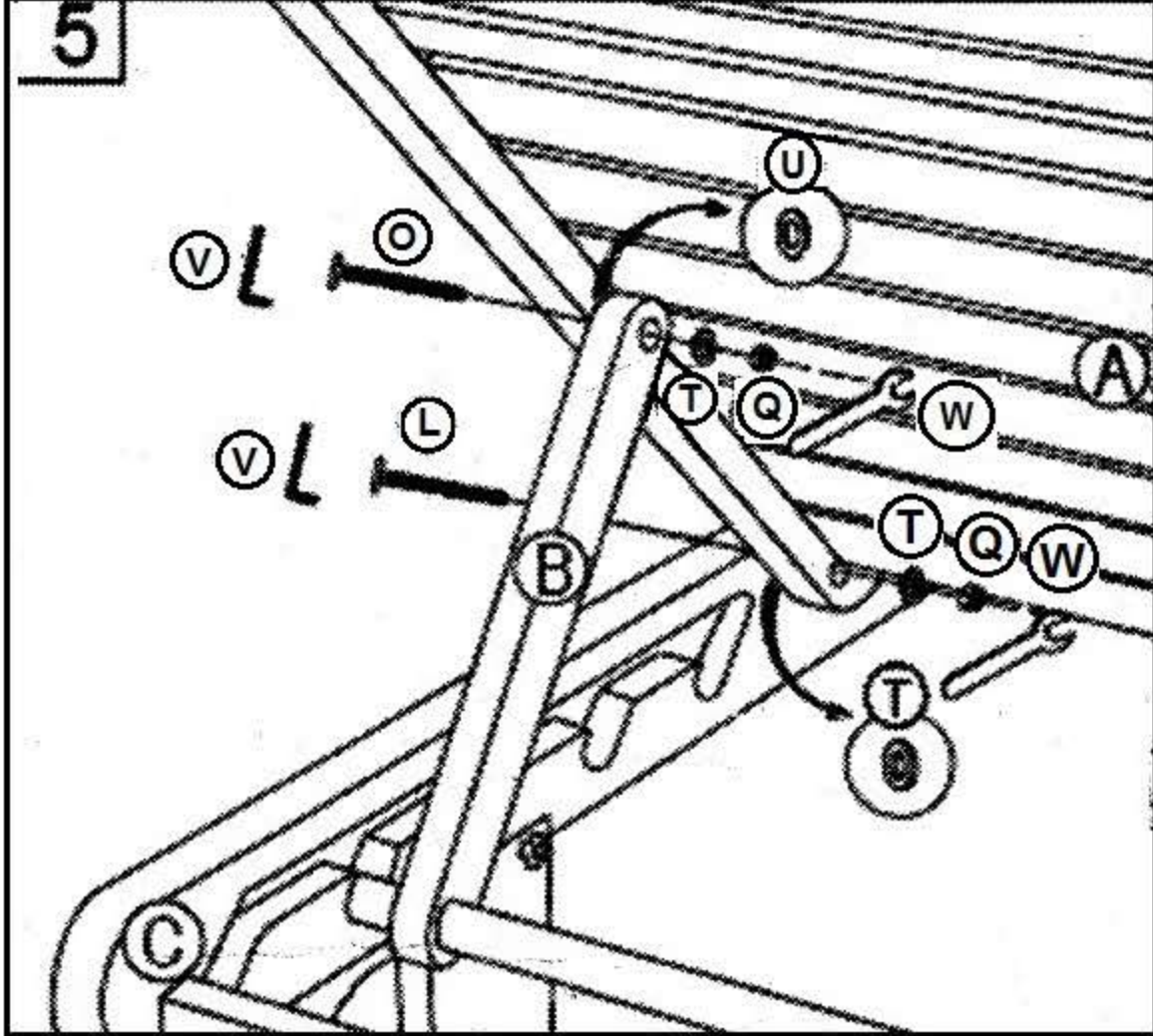
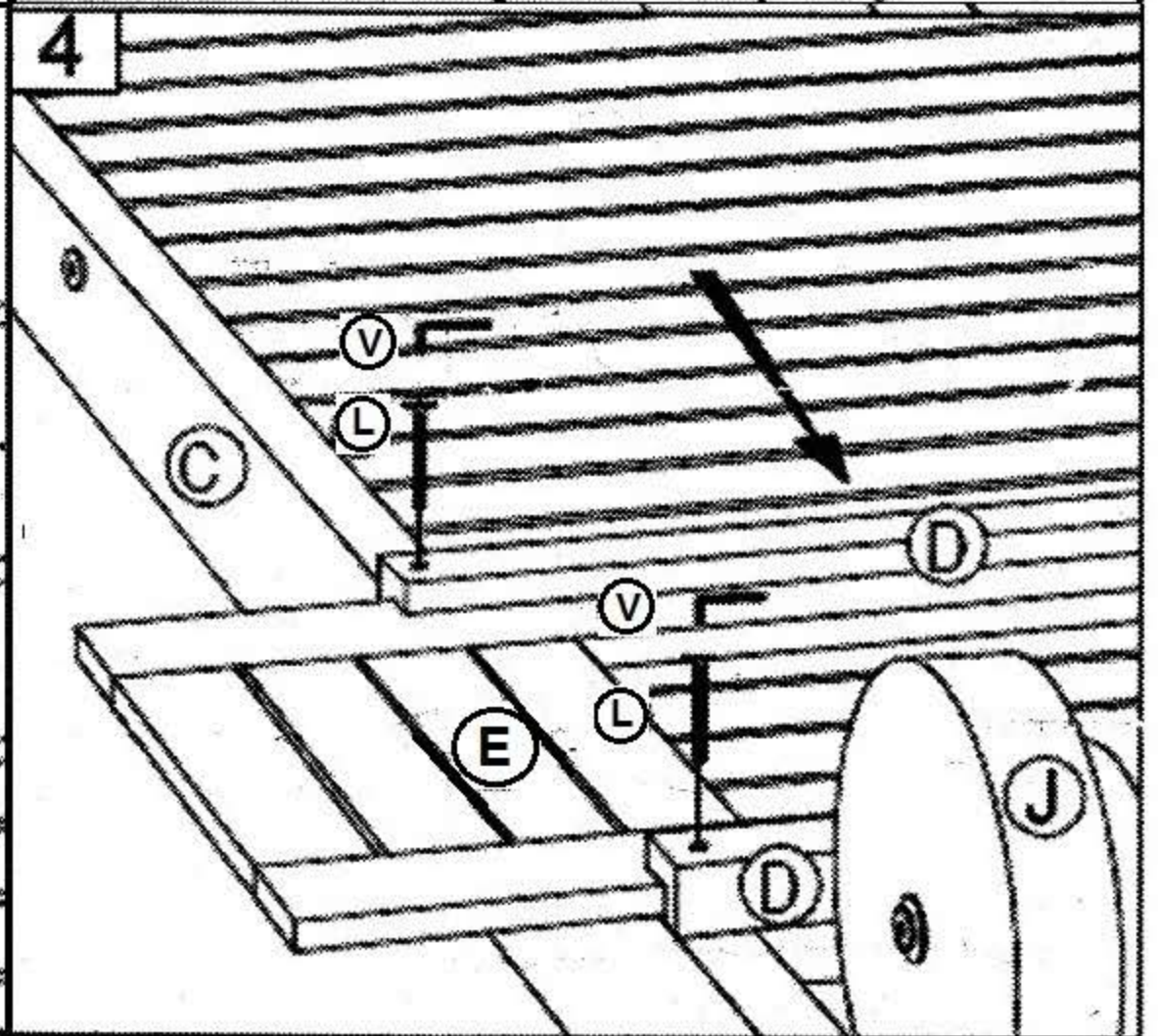
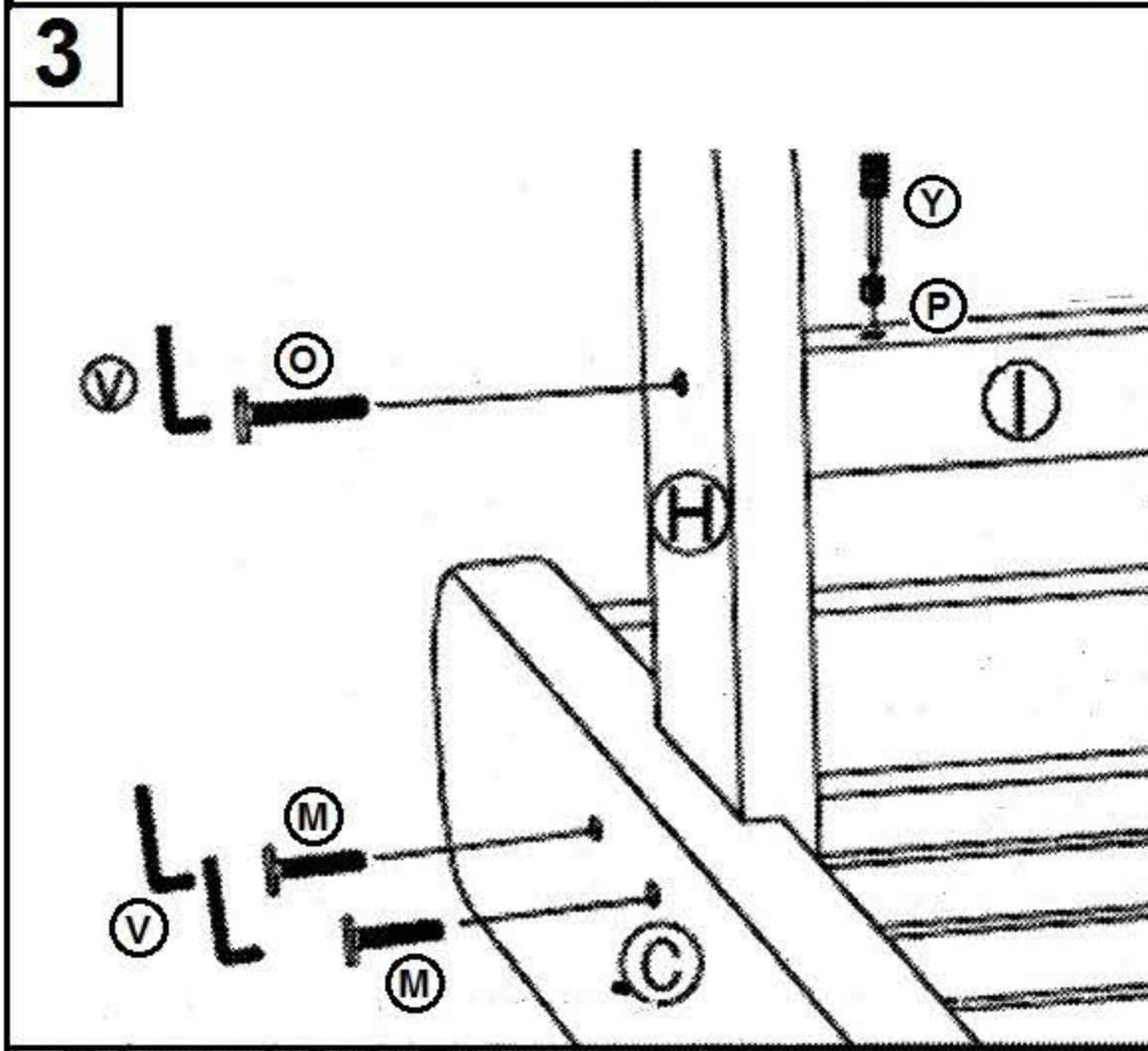
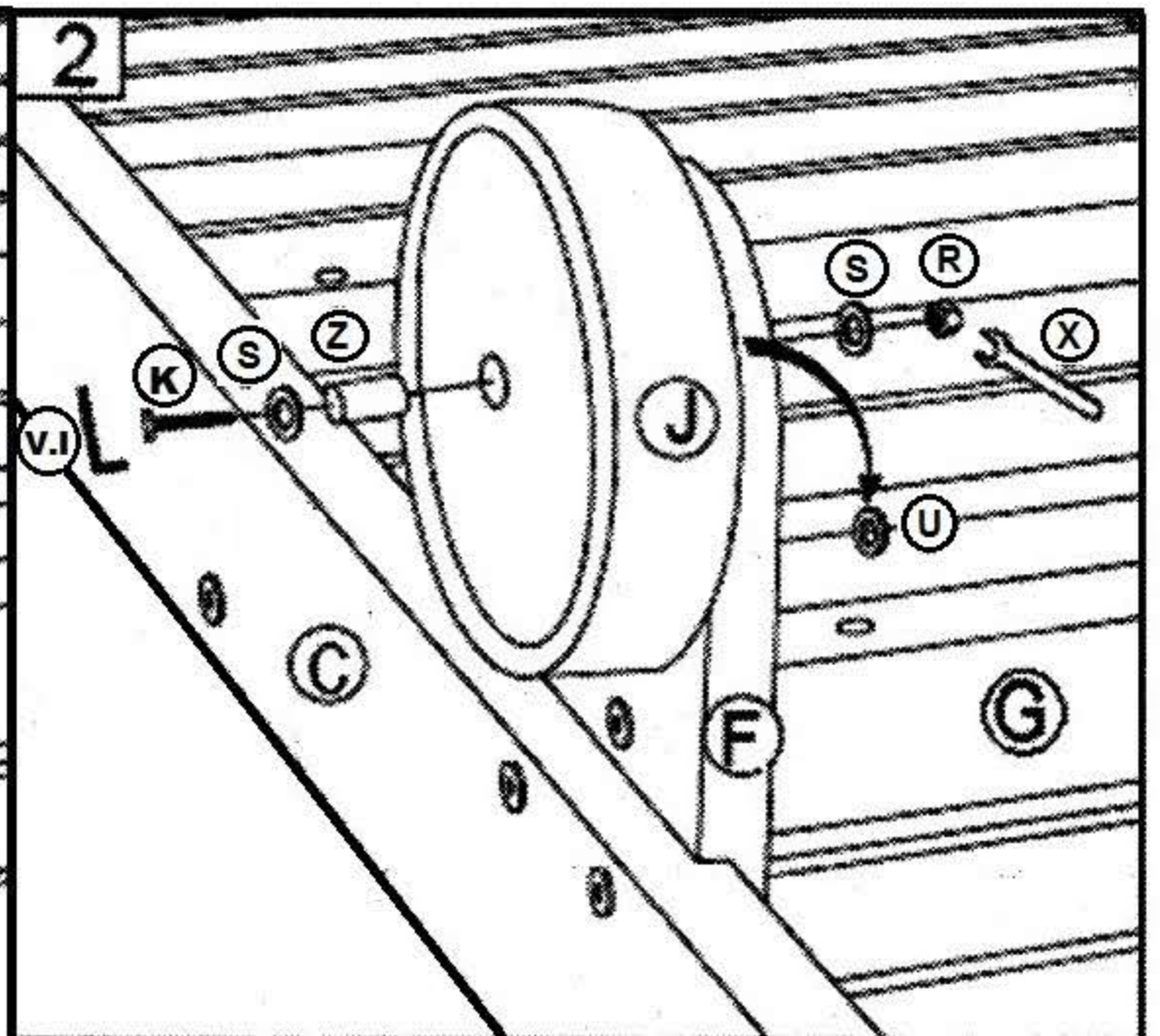
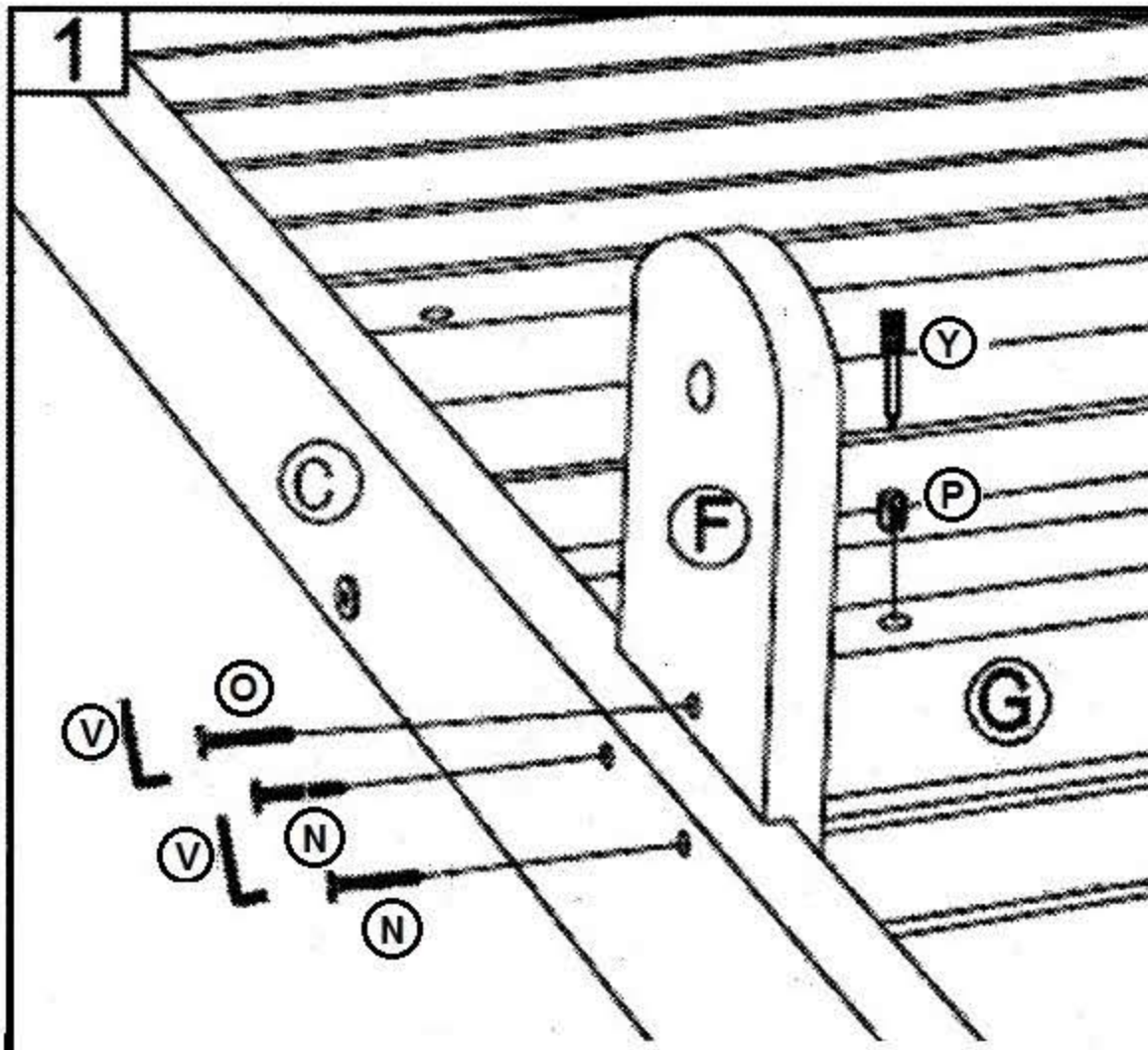

* Do Not Tighten Any Bolt Until All Bolt Have Been Placed.