

20'

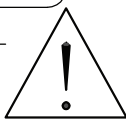

1

A

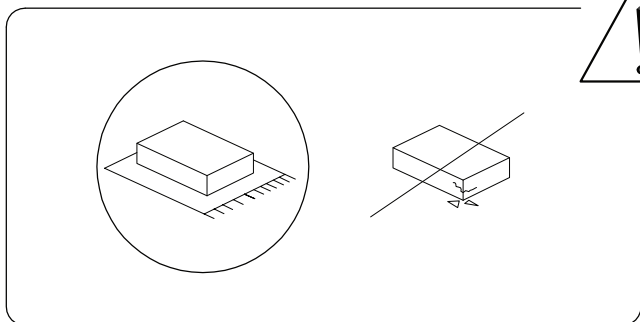
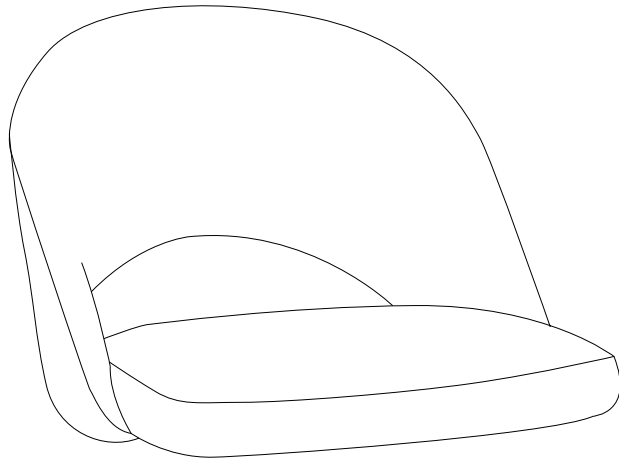

B

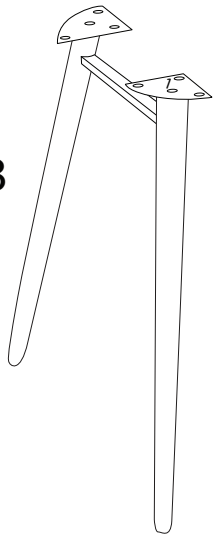

C

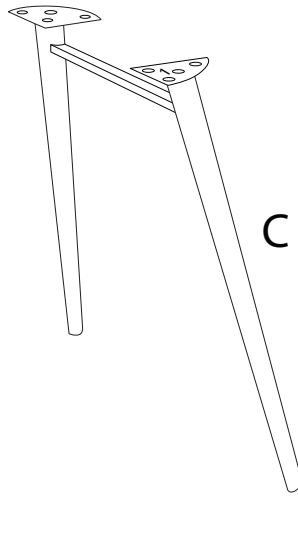

A

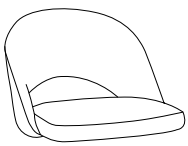

x 1

B

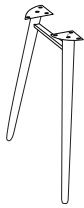

x 1

C

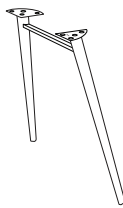

x 1

D

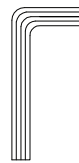



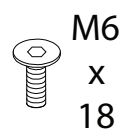

x 1

E

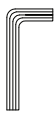

x 12

1

A  x 1	B  x 1	C  x 1	D  x 1	E  M6 x 18 x 12
------------------------------------------------------------------------------------------------------	------------------------------------------------------------------------------------------------------	------------------------------------------------------------------------------------------------------	--------------------------------------------------------------------------------------------------------	--------------------------------------------------------------------------------------------------------------------

