

Instruction manual
MODULAR SOFA

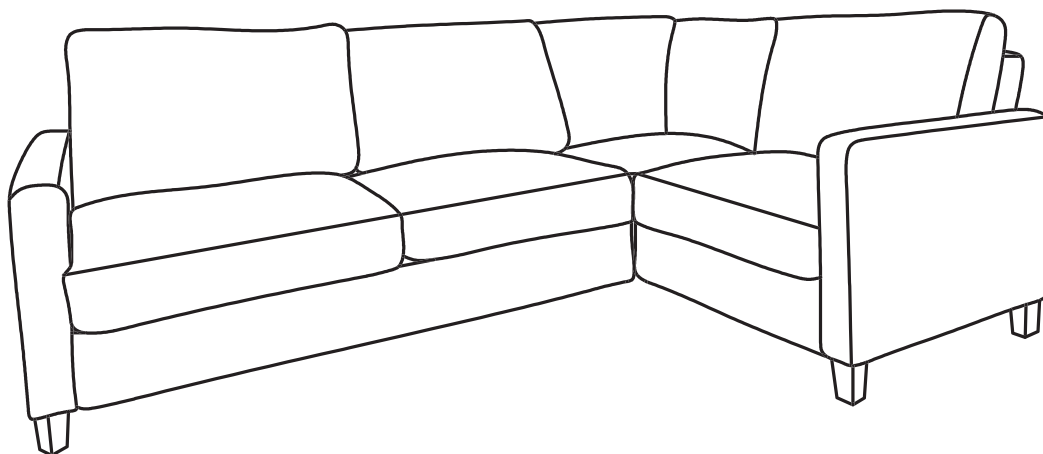

CONTENTS

Safety and care advice	1
Components	2
Assembly instructions	4
Copyright	10

⚠ SAFETY AND CARE ADVICE ⚠

PLEASE READ THESE INSTRUCTIONS CAREFULLY AND KEEP FOR FUTURE REFERENCE

- **Warning:** Please lift with care.
- Check you have all the components and tools listed on pages 2 and 3.
- Remove all fittings from the plastic bags and separate them into their groups.
- Keep children and animals away from the work area, small parts could choke if swallowed.
- Make sure you have enough space to lay out the parts before starting.
- Do not stand or put weight on the product, this could cause damage.
- Assemble the item as close to its final position (in the same room) as possible.
- Assemble on a soft level surface to avoid damaging the unit or your floor (use opened out unit carton).



- We do not recommend the use of power drill/drivers **for inserting screws**, as this could damage the unit. Only use hand screwdrivers.
- Dispose of all packaging carefully and responsibly.

CARE AND MAINTENANCE

- Only clean using a damp cloth and mild detergent, do not use bleach or abrasive cleaners.
- From time to time check that there are no loose screws on this unit.
- This product should not be discarded with household waste. Take to your local authority waste disposal center.

Note *If required the next page can be cut out and used as reference throughout the assembly. Keep this page with these instructions for future reference.*

COMPONENTS

Please check you have all the panels listed below:

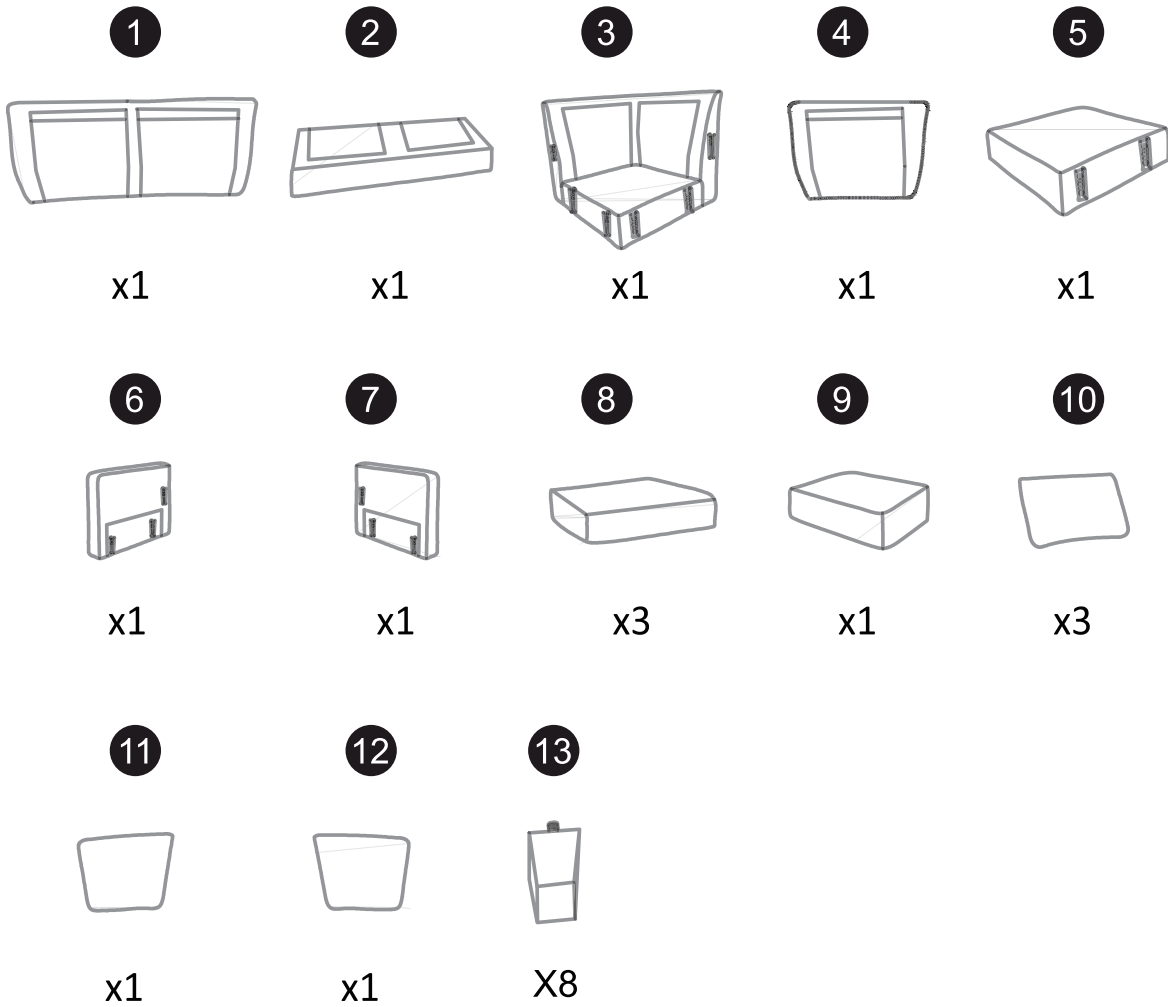

1	Backrest(2seater)	X1	8	Cushion (2 seater & 1 seater)	X3
2	Seat frame(2seater)	X1	9	Corner Cushion	X1
3	Corner frame	X1	10	Back cushion (2seater& 1 seater)	X3
4	Backrest (1seater)	X1	11	Back cushion (corner)	X1
5	Seat frame(1seater)	X1	12	Back cushion (corner)	X1
6	Armrest(Right after you sit down)	X1	13	Legs	X8
7	Armrest (Left after you sit down)	X1			



COMPONENTS

Please check you have all the fittings listed below:

A X9



M6X70mm

B X9

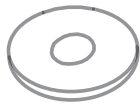

C X8

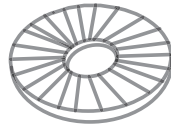

D x1



M6

E X8

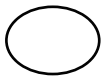

ASSEMBLY INSTRUCTIONS

Step 1

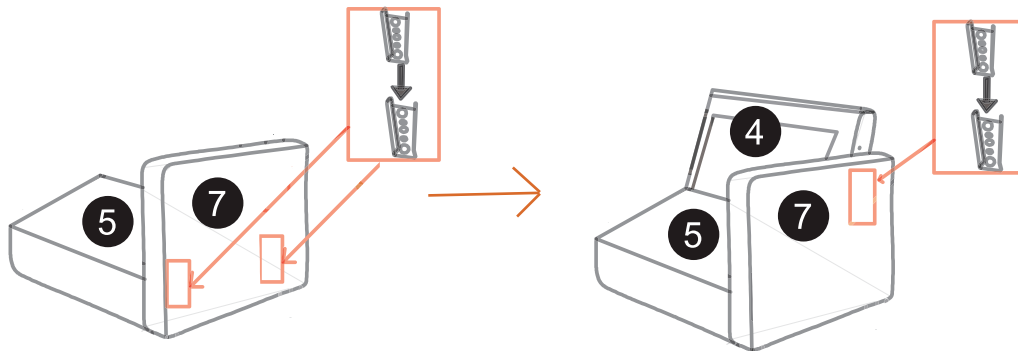

Step 2

D		1
A		3
B		3

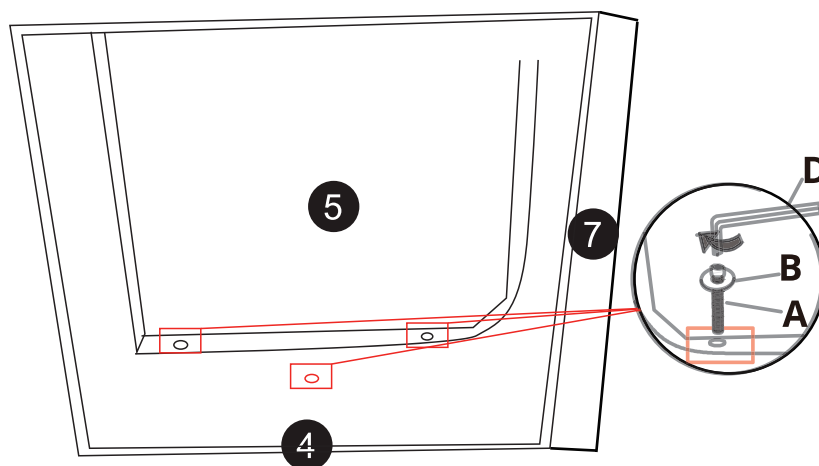

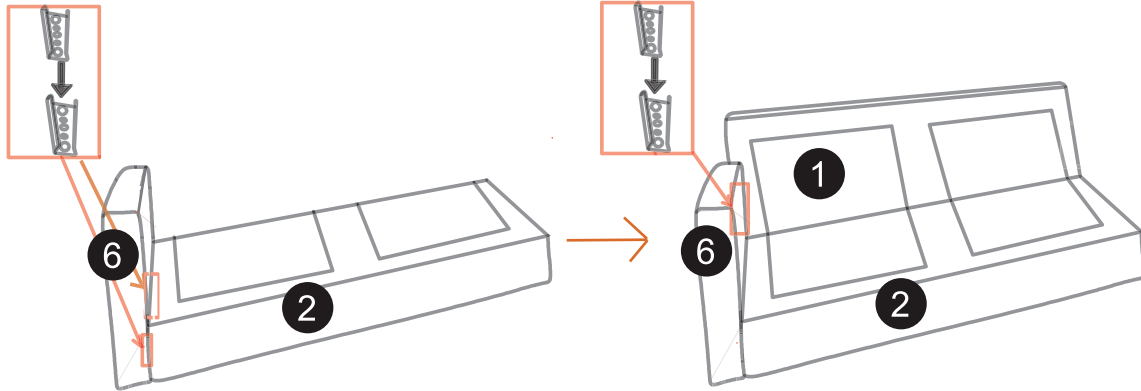

ASSEMBLY INSTRUCTIONS

Step 3



Step 4

D		1
A		6
B		6

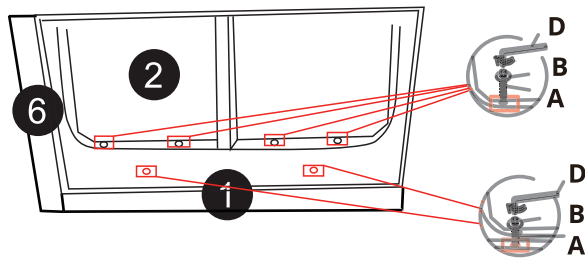



ASSEMBLY INSTRUCTIONS

Step 5

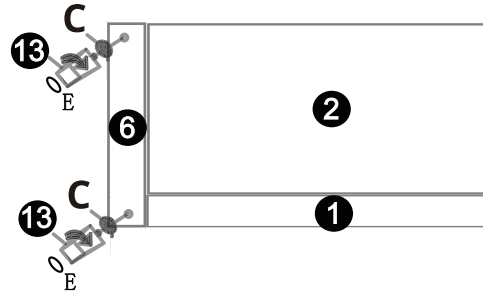
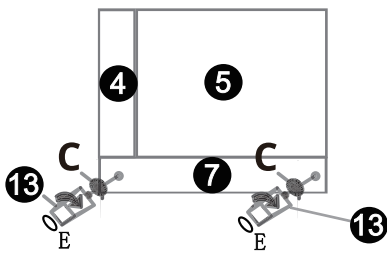
C		4
E		4



Step 6

C		4
E		4

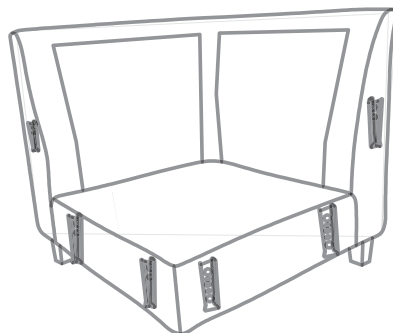
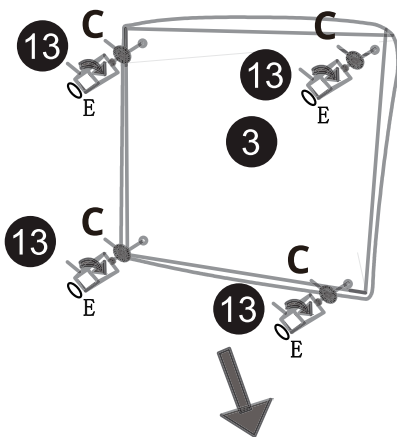

ASSEMBLY INSTRUCTIONS

Step 7

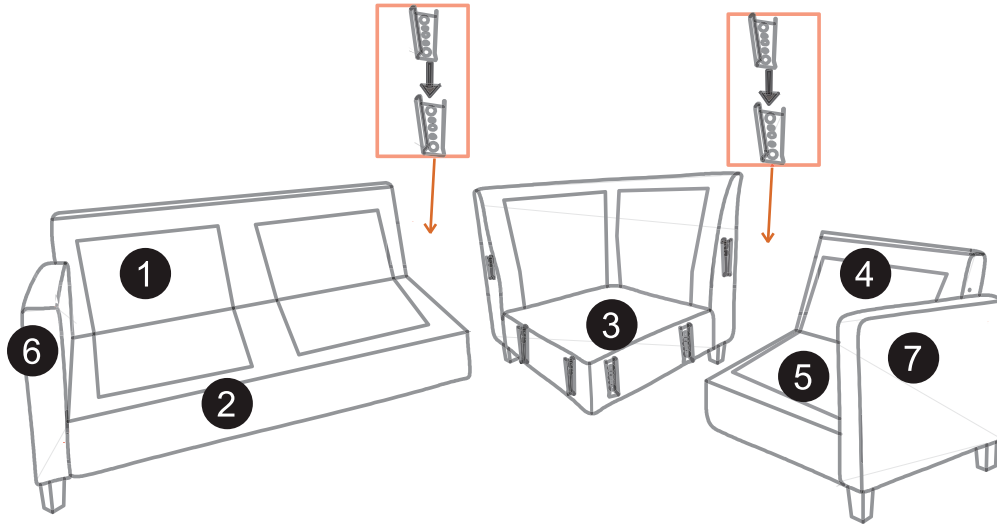

Step 8

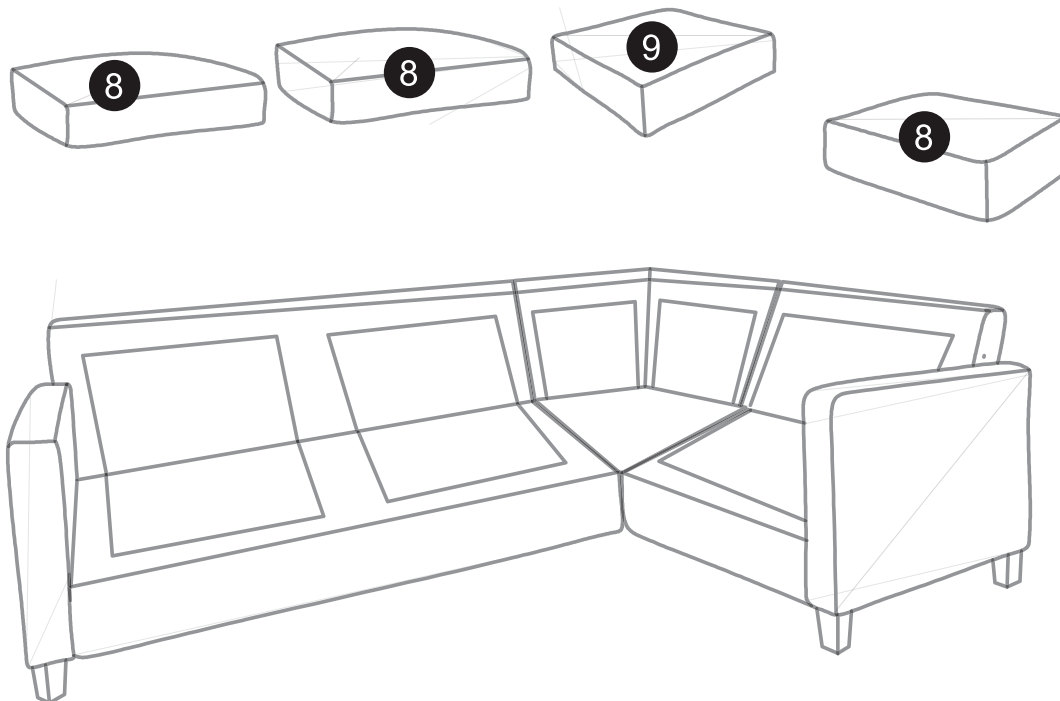

Peel off the velcro before putting cushions on the sofa.

ASSEMBLY INSTRUCTIONS

Step 9

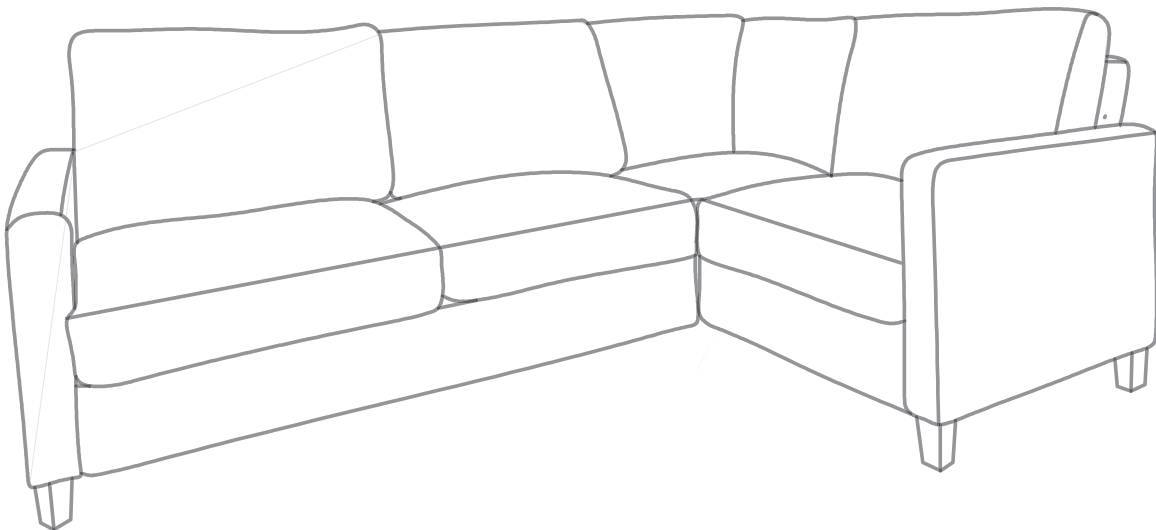
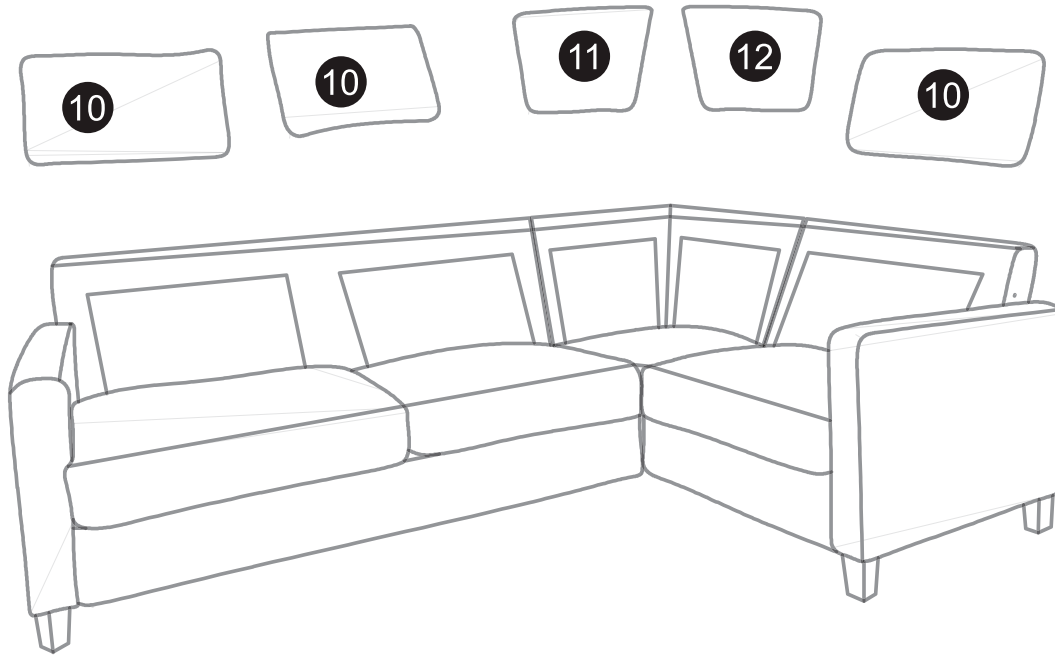

Congratulations! Now you have finished assembling the product.

ASSEMBLY INSTRUCTIONS

Option1

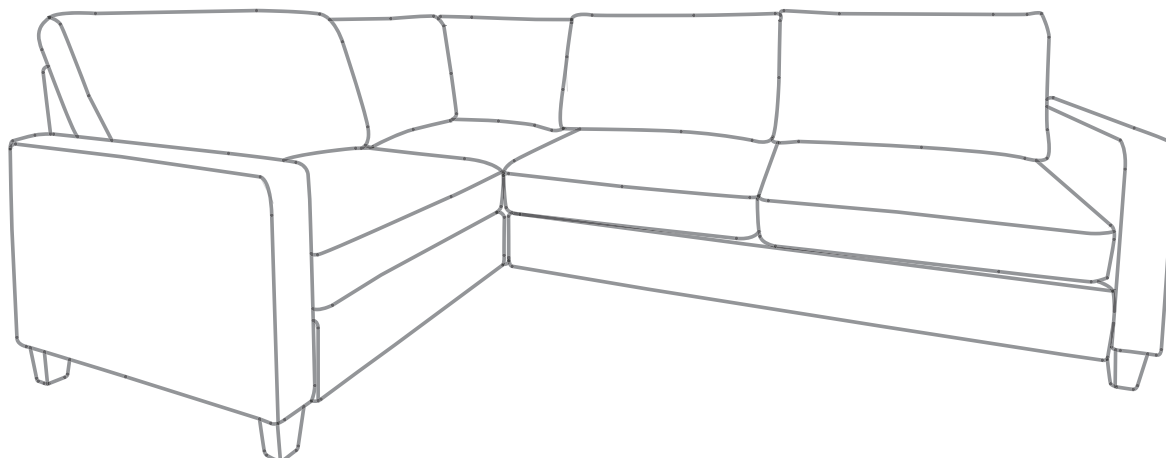

Option2

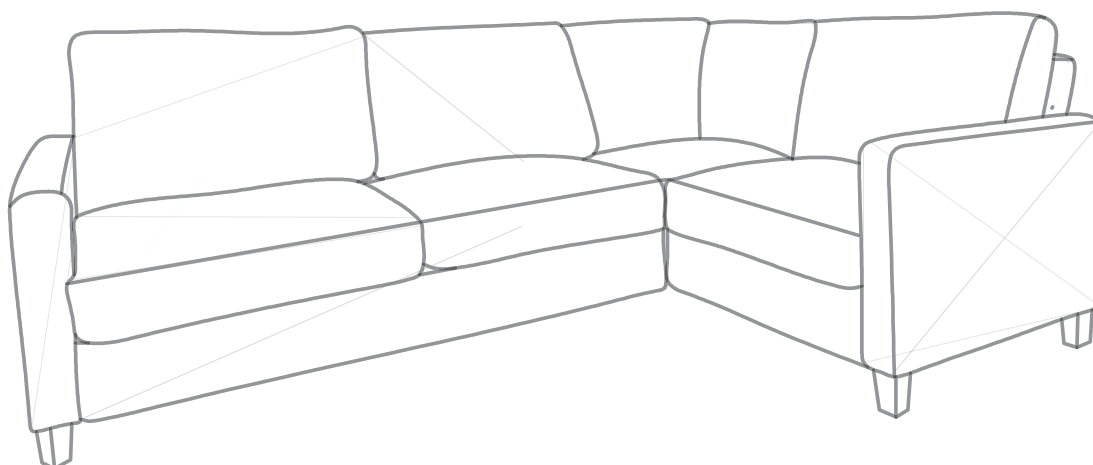

Option3

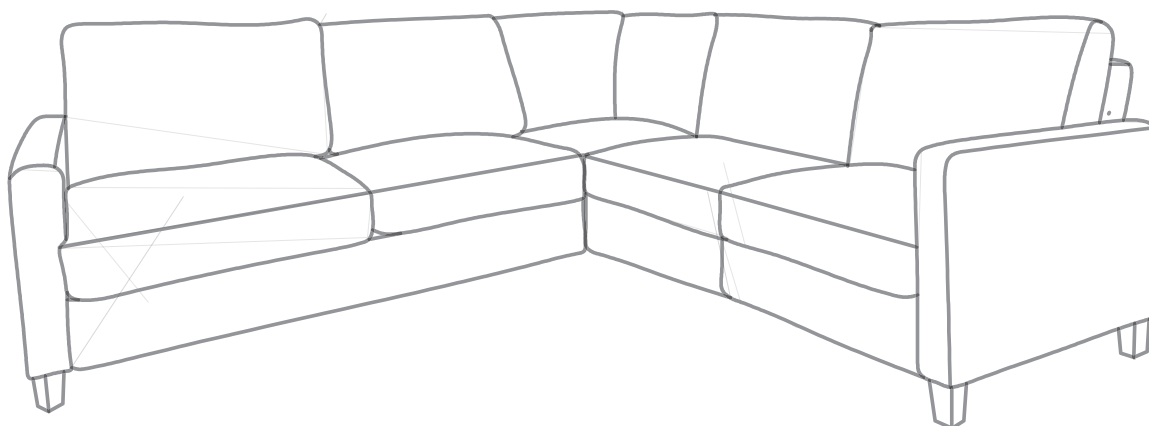

IF YOU FIND A DEFECTIVE PART

We fully stock all parts and components. Any defective part can be quickly replaced. Take note of the defective part number in manual and we will arrange a replacement.

COPYRIGHT

All material in this instruction manual is copyrighted

Any unauthorised use may violate worldwide copyright, trademark and other laws.