

- EN** - Please read this instruction manual carefully before attempting to install.
- DE** - Bitte lesen Sie diese Bedienungsanleitung vor der Montage gründlich durch.
- ES** - Por favor lea con atención el manual de instrucciones antes de llevar a cabo el ensamble.
- FR** - Lisez attentivement cette notice avant de commencer le montage.
- IT** - Si prega di consultare il libretto delle istruzioni prima del montaggio.

IMPORTANT/WICHTIG/ATENCIÓN

IMPORTANT/IMPORTANTE



EN - We recommend **2** or more people to install.
DE - Wir empfehlen, dass die Montage von **2** oder mehreren Personen durchgeführt werden sollte.
ES - Recomendamos realizar el ensamble con **2** o más personas.
FR - Il est recommandé d'effectuer le montage à **2** personne(s) ou plus.
IT - È necessaria la presenza di **2** o più persone per il montaggio di questo prodotto.



EN - The expected assembly time is **0.5** h.
DE - Die Montagezeit beträgt durchschnittlich **0.5** h.
ES - El tiempo aproximado de ensamble es de **0.5** h.
FR - Le temps nécessaire est estimé à **0.5** h.
IT - Il tempo previsto per il corretto assemblaggio è di **0.5** h.



EN - Not intended for use by children.
DE - Nicht geeignet für Kinder.
ES - Producto no apto para niños.
FR - Produit non destiné à être utilisé par des enfants.
IT - Questo prodotto non è destinato all'uso da parte dei bambini.



EN - Keep away from fire or other heat sources.
DE - Bitte von Feuer und Hitzequellen fernhalten.
ES - Manténgase alejado de las llamas y otras fuentes de calor.
FR - Tenir à distance des flammes et autres sources de chaleur.
IT - Tenere lontano dal fuoco o da altre fonti di calore.



EN - We recommend wearing protective gloves.
DE - Wir empfehlen das Tragen von Schutzhandschuhen.
ES - Recomendamos el uso de guantes de seguridad.
FR - Il est recommandé de porter des gants de protection.
IT - Per il processo di assemblaggio, consigliamo fortemente l'utilizzo di guanti protettivi.

EN - Please follow the instruction manuals and use a pad to avoid damage during assembly.









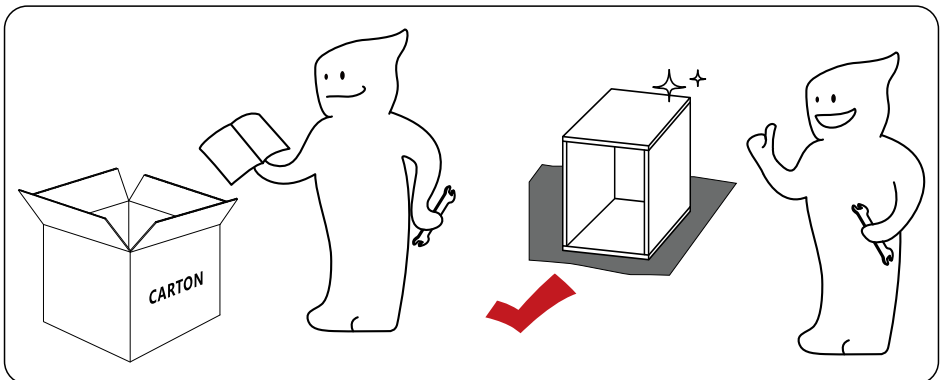
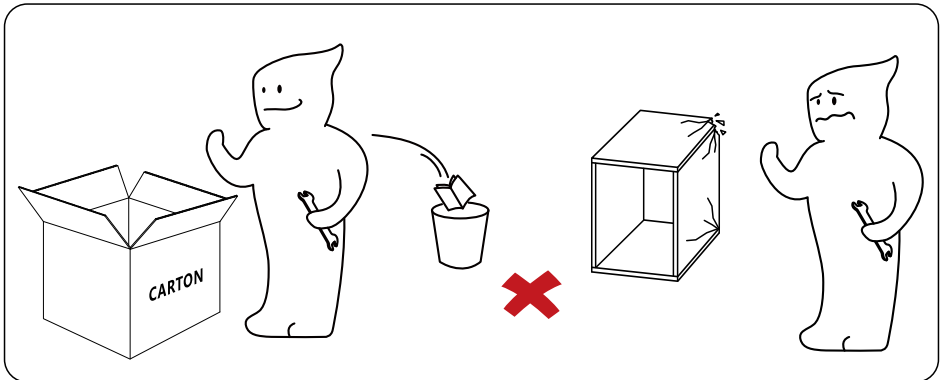

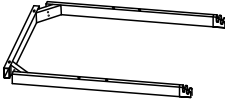
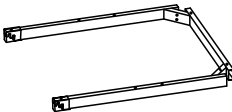

DE - Bitte folgen Sie der Anleitung und verwenden Sie eine Unterlage, um Beschädigungen bei der Montage zu vermeiden.

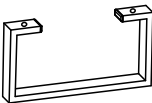
ES - Por favor siga las instrucciones del manual y utilice una cubierta o lona para proteger el producto y los suelos durante la instalación.

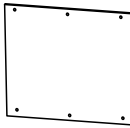
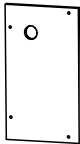
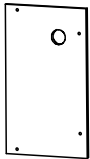
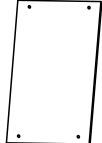
FR - Suivez les instructions de la notice et utilisez une couverture ou une bâche pour protéger le produit et les sols pendant le montage.

IT - Si prega di consultare il manuale illustrativo durante il montaggio e di utilizzare un cuscinetto per evitare possibili danni.

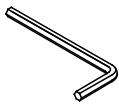

<p>① × 1</p> 	<p>② × 1</p> 	<p>③ × 2</p> 
<p>④ × 2</p> 	<p>⑤ × 2</p> 	<p>⑥ × 2</p> 
<p>⑦ × 1</p> 	<p>⑧ × 1</p> 	<p>⑨ × 1</p> 
<p>⑩ × 1</p> 	<p>⑪ × 1</p> 	<p>Ⓐ × 4</p> 
<p>Ⓑ × 22</p>  <p>50mm</p>	<p>Ⓒ × 4</p>  <p>55mm</p>	<p>Ⓓ × 5</p> 
<p>Ⓔ × 4</p> 	<p>Ⓕ × 1</p> 	

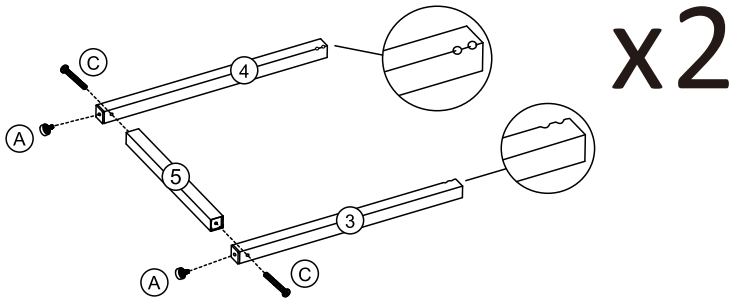
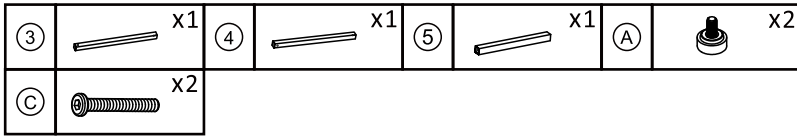
1

EN - During the assembly, please first half-tighten all the screws into the holes. After all the screws are set, fully tighten them.

DE - Bei der Montage ziehen Sie bitte zuerst alle Schrauben leicht von Hand fest. Erst nachdem alle Schrauben eingedreht sind, ziehen Sie diese dann vollständig mit dem Inbusschlüssel fest.



ES - Durante el montaje, apriete todos los tornillos sólo hasta la mitad. después de insertar todos los tornillos, apriételes completamente.

FR - Pendant le montage, il est recommandé de ne serrer les vis qu'à demi. Ne vissez à fond qu'une fois toutes les vis insérées.

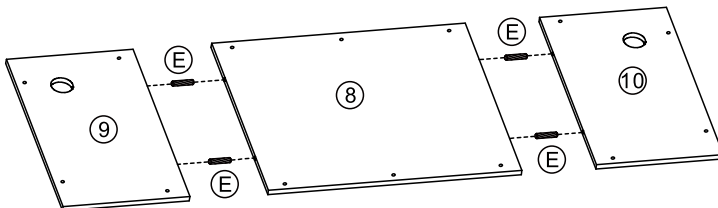
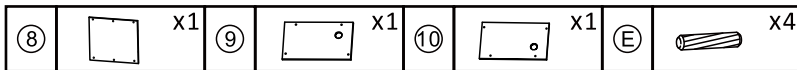
IT - Durante il montaggio, si prega di stringere tutte le viti solo a metà. Solamente dopo aver inserito tutte le viti, stringerle completamente.

2

3

①	 X1
Ⓑ	 X6

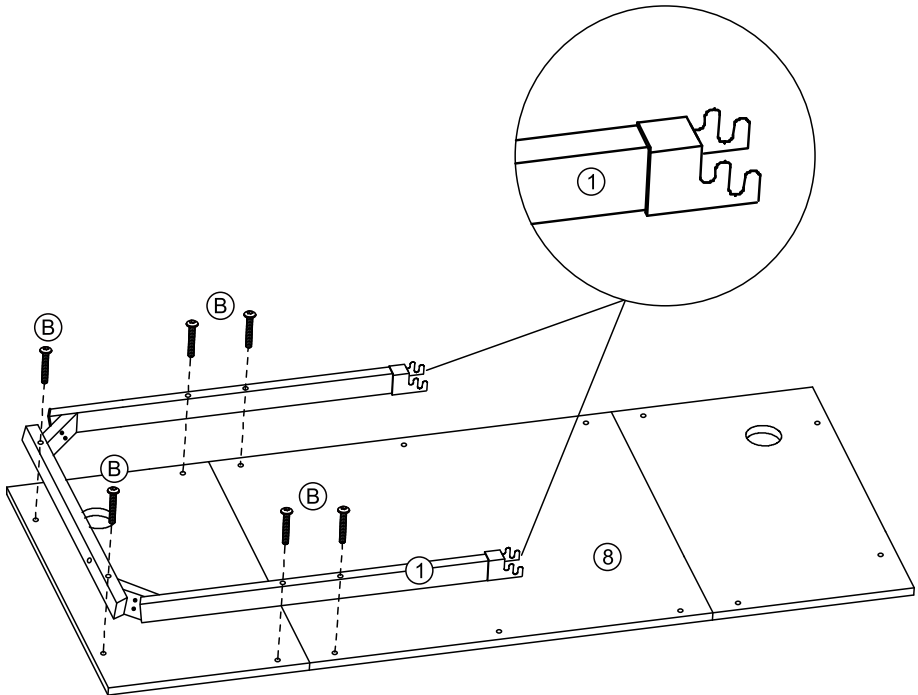

EN - Note: Don't tighten screws completely at this step.
DE - Hinweis: Ziehen Sie die Schrauben bei diesem Schritt nicht vollständig an.
ES - Nota: No apriete los tornillos completamente en este paso.
FR - NB: Ne serrez pas les vis complètement à ce stade.
IT - Nota: Non stringere completamente tutte le viti in questo passaggio.

4

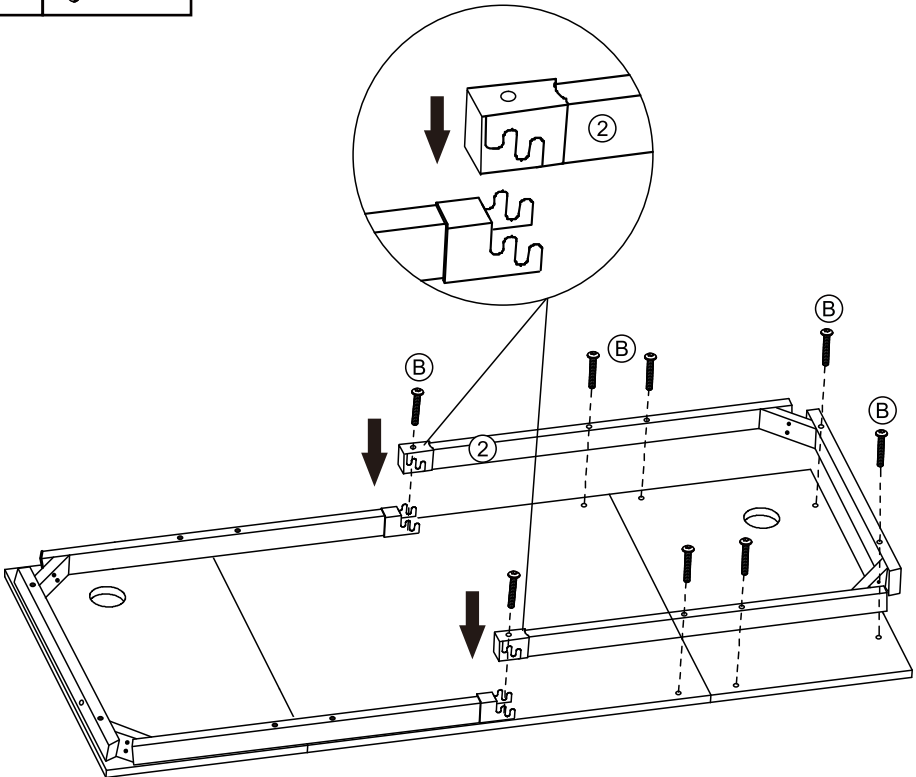
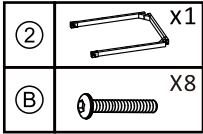

EN - Note: Tighten all screws completely after assembly.

DE - Hinweis: Ziehen Sie nach der Montage alle Schrauben vollständig an.

ES - Nota: Apretar completamente todos los tornillos después de montar.

FR - NB : Serrez les vis complètement après l'assemblage.

IT - Nota: Stringere completamente tutte le viti solo dopo l'assemblaggio.

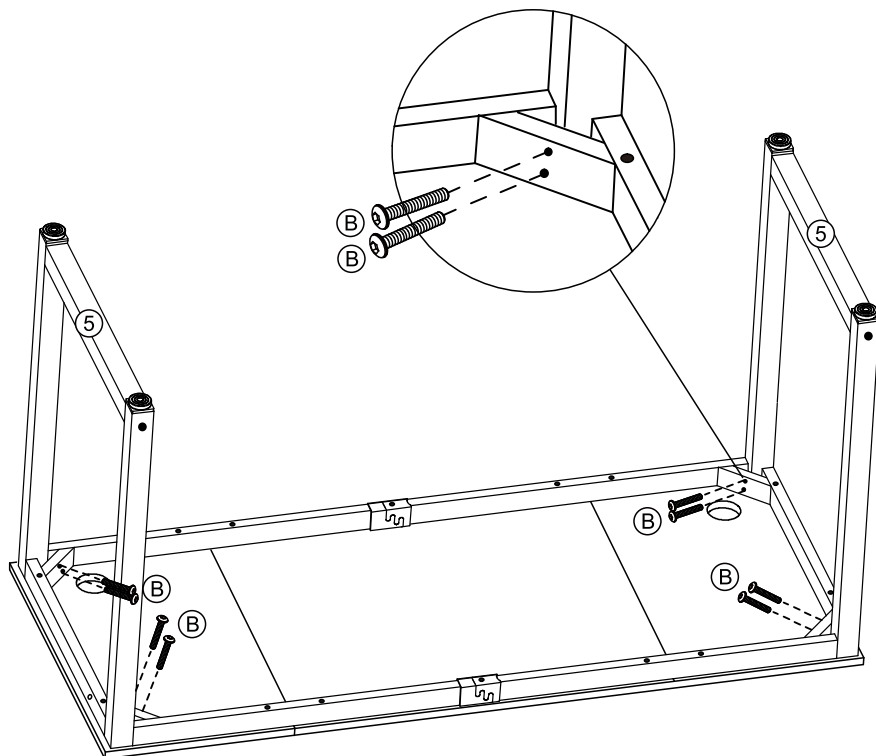
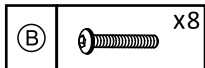
5

EN - During the assembly, please first half-tighten all the screws into the holes. After all the screws are set, fully tighten them.



DE - Bei der Montage ziehen Sie bitte zuerst alle Schrauben leicht von Hand fest. Erst nachdem alle Schrauben eingedreht sind, ziehen Sie diese dann vollständig mit dem Inbusschlüssel fest.

ES - Durante el montaje, apriete todos los tornillos sólo hasta la mitad. después de insertar todos los tornillos, apriételes completamente.

FR - Pendant le montage, il est recommandé de ne serrer les vis qu'à demi. Ne vissez à fond qu'une fois toutes les vis insérées.



IT - Durante il montaggio, si prega di stringere tutte le viti solo a metà. Solamente dopo aver inserito tutte le viti, stringerle completamente.

6

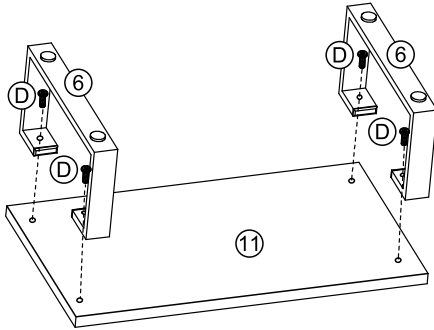
⑥		x2
⑪		x1
ⓓ		x4



7

⑦		x1
ⓓ		x1

