







# ASSEMBLY INSTRUCTIONS

## (BOX 1) BOX OF HEADBOARD

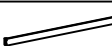
ITEM	DRAWING	DESCRIPTION	QTY
A		HEADBOARD PANEL	1
B		LEFT HEADBOARD LEG	1
C		RIGHT HEADBOARD LEG	1
D		HB BOTTOM RAIL	1









## (BOX 2) BOX OF FOOTBOARD

ITEM	DRAWING	DESCRIPTION	QTY
E		FOOTBOARD	1
F		WOODEN SLAT	4
G		WOODEN SUPPORT	4

## (BOX 3) BOX OF SIDE RAIL

ITEM	DRAWING	DESCRIPTION	QTY
H		SIDE RAIL	2

## (BOX 1) HEADBOARD HARDWARE LIST

ITEM	DRAWING	DESCRIPTION	QTY
1		ALLEN WRENCH (M4(BALL SHAPE)110mm)	1
2		ALLEN WRENCH (M5)	1
3		CONNECTION BOLT (M8 x 20mm) W/WASHER & SPRING WASHER	8
4		CONNECTION BOLT (M6 x 40mm) W/WASHER & SPRING WASHER	8
5		CONNECTION BOLT (M6 x 50mm) W/WASHER & SPRING WASHER	2
6		WOOD DOWEL (M8 x 30mm)	4
7		FLAT HEAD SCREW (#8 x 1 1/8")	8
8		Assembly Tool Not Included	1

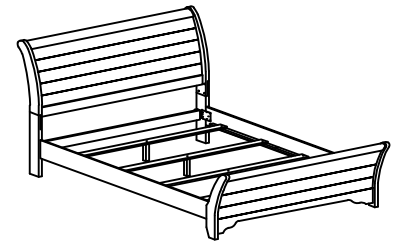

## COMPLETED QUEEN BED ASSEMBLY

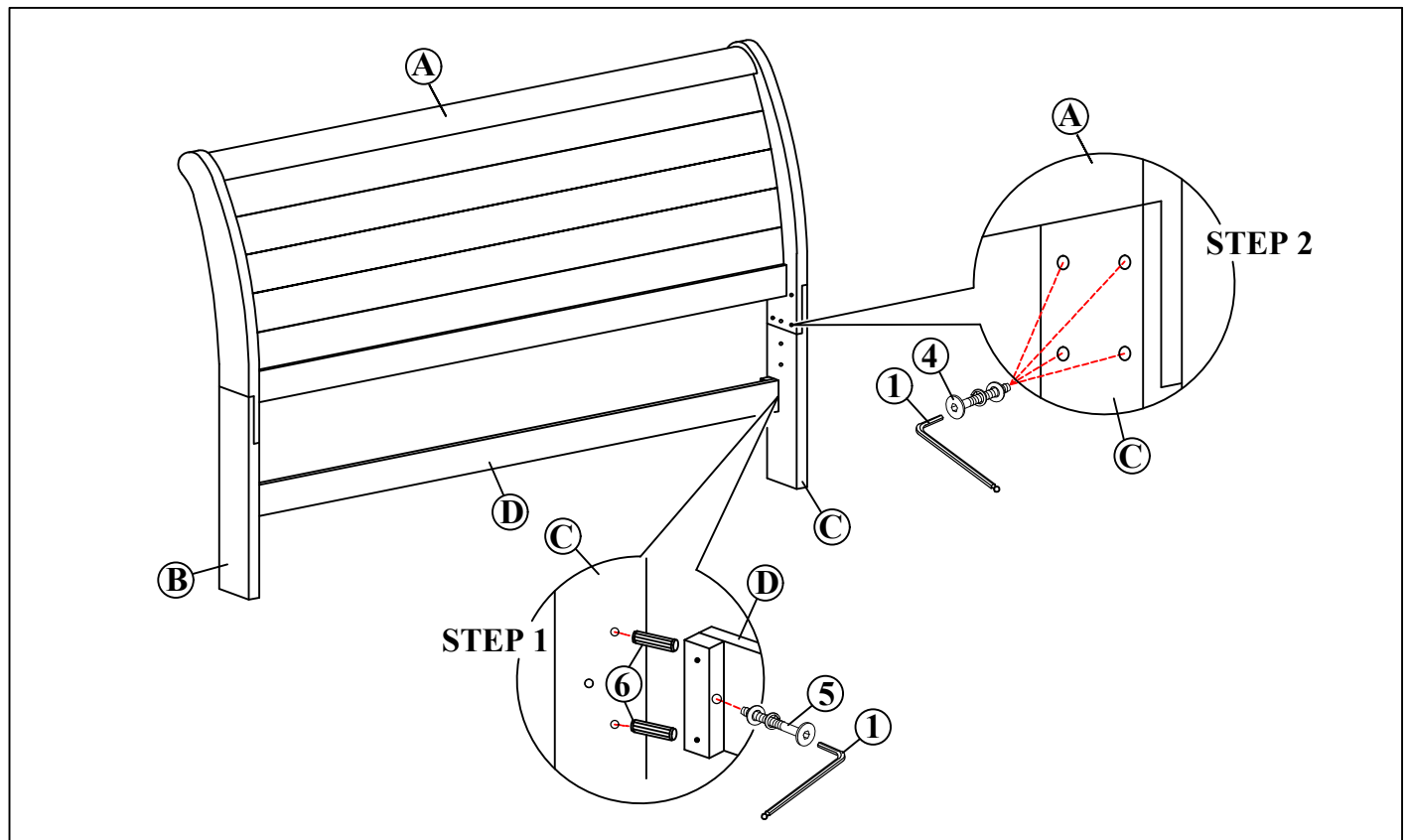

THE HARDWARE IS LOCATED IN THE PACKING ITEMS

NOTE : MUST TIGHTEN SCREWS PERIODICALLY. WITH USE SCREW MAY BECOME LOOSE.  
CHECK TIGHTNESS OF ALL SCREW EVERY 6-8 WEEKS.

### CLEANING INSTRUCTION

After assembly, clean & polish the completed parts if necessary with soft cloth and industrial recognized furniture polish

# ASSEMBLY INSTRUCTIONS

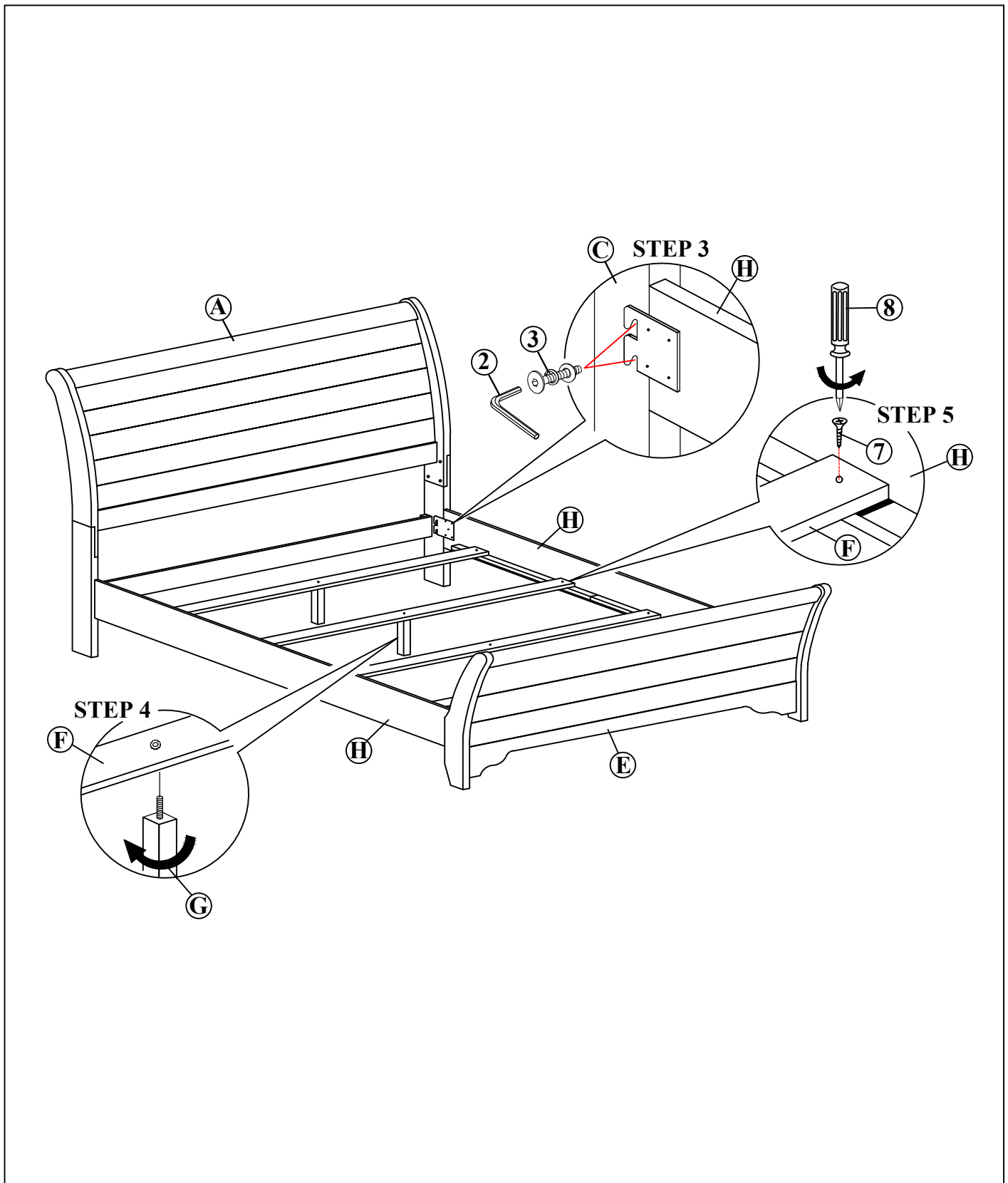

THE HARDWARE IS LOCATED IN THE PACKING ITEMS

NOTE : MUST TIGHTEN SCREWS PERIODICALLY. WITH USE SCREW MAY BECOME LOOSE.  
CHECK TIGHTNESS OF ALL SCREW EVERY 6-8 WEEKS.

## CLEANING INSTRUCTION

After assembly, clean & polish the completed parts if necessary with soft cloth and industrial recognized furniture polish

MADE IN MALAYSIA