

Lighted Makeup Mirror

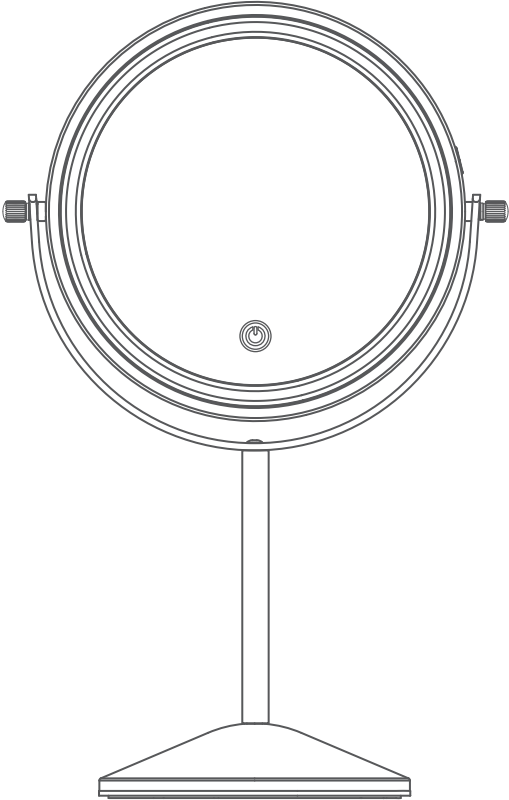

USER MANUAL

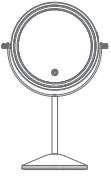

Lighted Makeup Mirror

INSTALLATION

IMPORTANT SAFETY INSTRUCTION

⚠ WARNING – TO REDUCE THE RISK OF BURNS, FIRE, ELECTRIC SHOCK OR INJURY TO PERSONS:

- Read all instructions before using the appliance.
- Do not operate where aerosols presents.
- Be sure mirror is not in a position where it can reflect sunlight; reflected sunlight can cause fire.
- Do not place or store this furnishing where it can fall or be pulled into a tub or sink.
- This appliance is not a toy,keep it away from children.
- The light source of this luminaire is not replaceable; when the light source reaches its end of life the whole luminaire shall be replaced.

PLEASE SAVE THESE INSTRUCTIONS FOR FUTURE REFERENCE



Lighted Makeup Mirror

INSTALLATION

SPECIFICATIONS

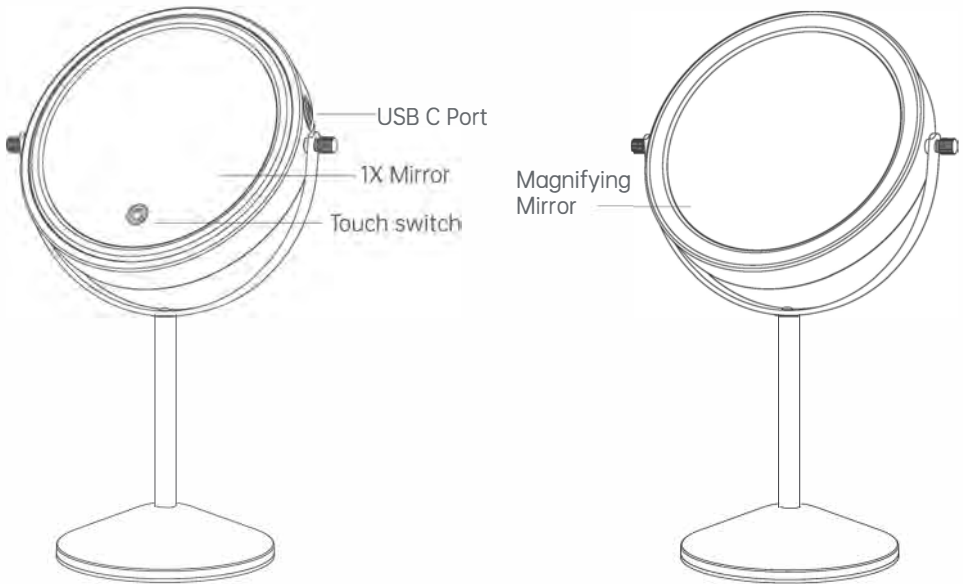

- Lighted Makeup Mirror
- Magnifying Mirror and 1X mirror
- Rechargeable 2000mAh battery
- Dimmable with touch switch
- Color Temperature: 3500K-7000K \pm 500K
- Material: Metal+Glass
- Input: 5V $\overline{=}$ 2A

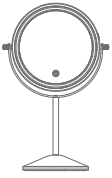

Lighted Makeup Mirror

INSTALLATION

ACCESSORIES AND DIMENSIONS

PARTS INCLUDED



USB C Cable



Cleaning Cloth



User Manual

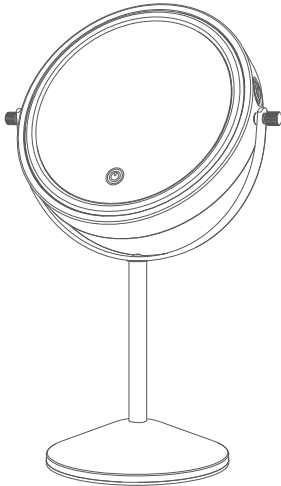

Mirror

DIMENSION

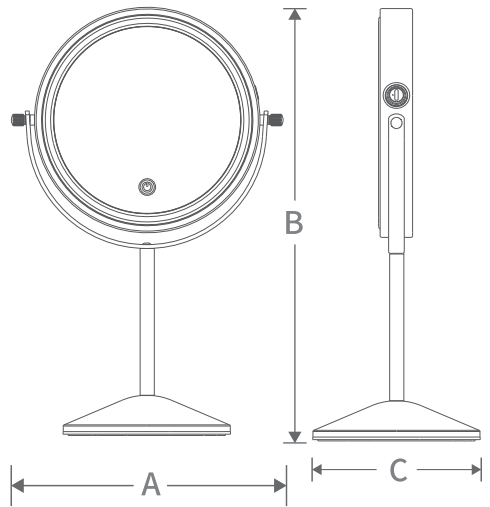

A	B	C
8"	15"	5.1"

A Mirror Diameter **B** Mirror Height **C** Base Diameter

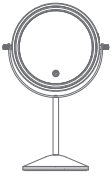

Lighted Makeup Mirror

INSTALLATION

ASSEMBLY AND USING

- 1** Install the mirror onto the base, rotate the mirror clockwise until it is fixed.

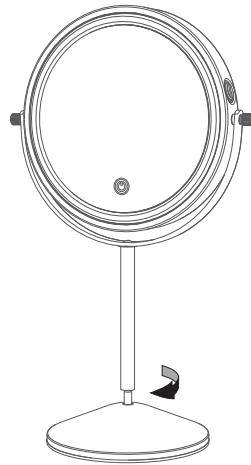
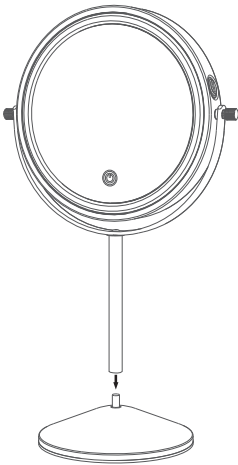

- 2** Make sure the mirror is fully charged before use.

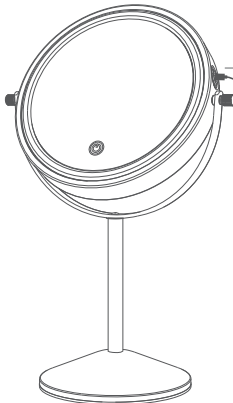

To Adapter

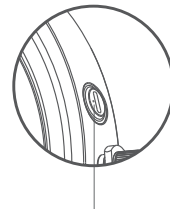

Charging : charging indicator:(Red)

Fully charged: charging indicator:(Blue)

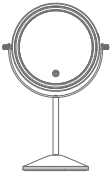

Lighted Makeup Mirror

INSTALLATION

OPERATION GUID

How to use this switch

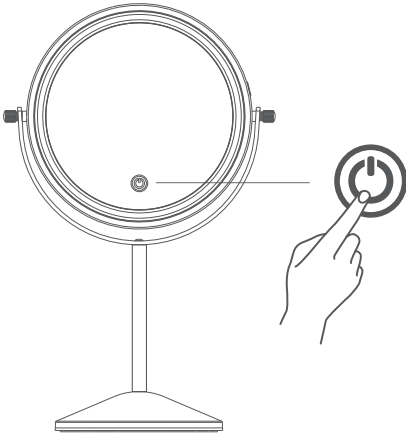

① **On/Off Lights**

Touch the switch to turn the light on or off.

② **Adjustable Brightness**

Long press to adjust brightness.

③ **Change Color Temperature**

Short press to select warm white or natural white light or daylight as you need.

How to use magnifying mirror

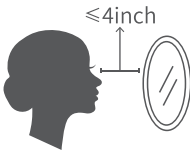

**Viewing distance WITHIN 4 inch
to avoid dizziness**

Notes: Please make viewing distance within 4 inch to avoid dizziness and inverted image

(When you are further from the mirror, the image is inverted. As you get closer, the image flips to the actual virtual image in magnification standard. This is because of the concave lens of the Magnifying Mirror.)

⚠ Please make sure the mirror is fully charged before use.

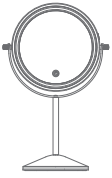

Lighted Makeup Mirror

INSTALLATION

TROUBLESHOOTING

PROBLEM	POSSIBLE CAUSE	CORRECTIVE ACTION
LED light not working	Battery is depleted	Charge the battery
Battery not charging	Damaged charging cable	Replace with new charging cable
	Adapter not working	Replace with new adapter
The mirror will not stay in place	Screw loose	Tighten the screws

MIRROR MAINTENANCE:

1. Make sure that LED lights are OFF before cleaning.
2. Use a soft wet cloth to remove dirt and stains. Wipe with dry cloth afterwards.
3. You can use a velvet cloth for better result in cleaning (velvet cloth not included).
4. Be sure direct sunlight does not strike the mirror. When left unattended, reflected sunlight can cause fire.
5. To protect the mirror from dust simply store it in its original box.
6. Store out of reach of children in a safe dry location.



For your safety and continued enjoyment of this product, always read the instruction book carefully before using.