

**Storage Cabinet**

**EN**

Thank you for purchase on our products. Please contact us if you have difficulty with assembly or need replacement parts. Our customer service is here to assist you. Please attach your User Name or Order ID so that we can assist you better.

## **WARNING**

Serious or fatal injury may occur from unexpected assembly or use.

1. During the assembly process, keep all parts away from babies or children.
2. Always securely fix this product to the wall. Make sure the wall area to be drilled is free from hidden electrical wires, water and gas pipes.
3. Use of tip-over restraints may only reduce, but not eliminate the risk of tip-over.
4. Unless specially designed to accommodate, do not set heavy objects on top of this product.
5. Place the heaviest items on the lowest shelf.
6. Never allow children to climb or bang on drawers, doors or shelves.

**DE**

Vielen Dank für Ihren Kauf von uns Produkten. Bitte kontaktieren Sie uns, wenn Sie Probleme mit Montage haben oder Ersatzteile benötigen. Wir Kundenservice ist für Sie da. Bitte geben Sie Ihren Benutzernamen oder Ihre Bestellnummer an, damit wir Sie besser unterstützen können.

## **WARNUNG**







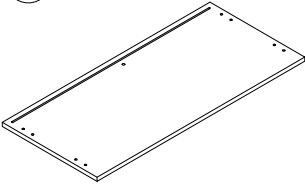
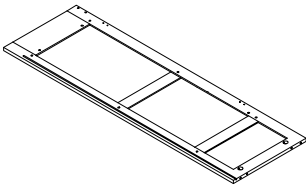
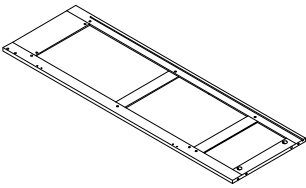
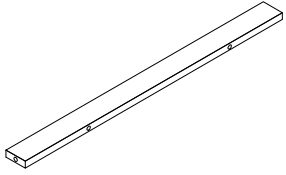
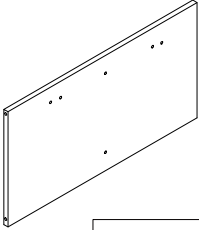
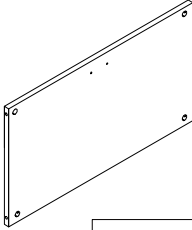
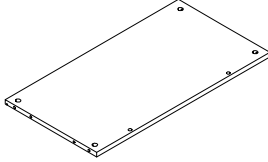
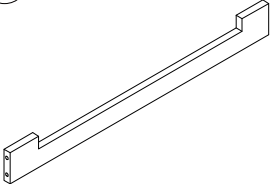
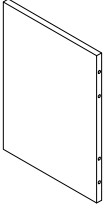
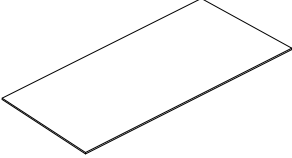
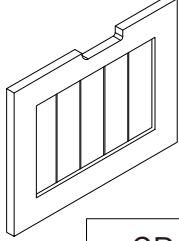
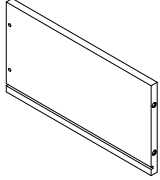
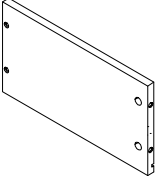
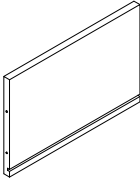
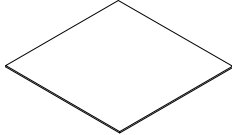
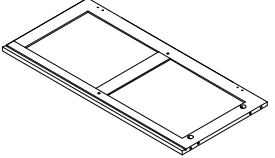
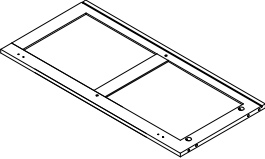
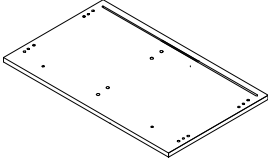
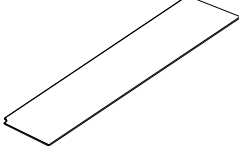
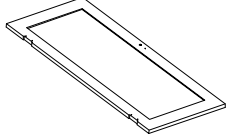
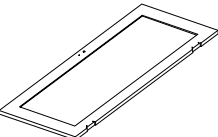
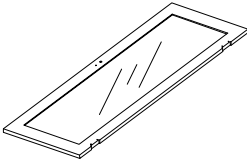
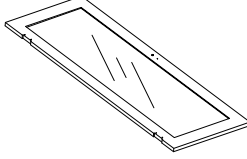

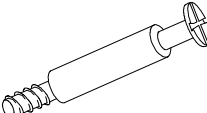
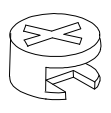
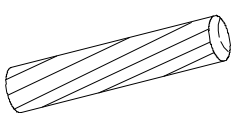
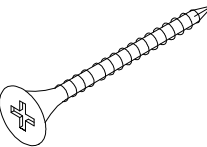
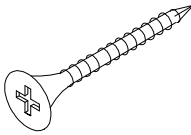

Bei unerwarteter Montage oder Verwendung können schwere oder tödliche Verletzung auftreten.

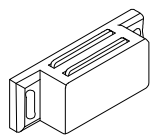
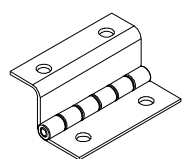
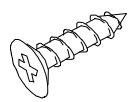
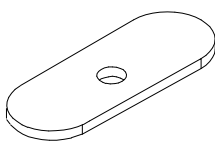
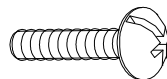
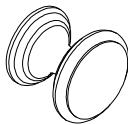
1. Legen Sie in den Montageprozess alle Teile weg von Babys oder Kindern.
2. Stellen Sie sicher, dass der gebohrte Wandbereich frei von verborgenen Stromkabeln, Wasser- und Gasleitungen ist, wenn Sie dieses Produkt an der Wand befestigen.
3. Die Verwendung von Kippsicherungen kann die Gefahr eines Kippens nur verringern, jedoch nicht beseitigen.
4. Setzen Sie bitte keine schweren Gegenstände auf dieses Produkt, es sei denn, dass das Produkt speziell für die Unterbringung konzipiert wird.
5. Legen Sie bitte die schwersten Gegenstände auf das unterste Regal.
6. Erlauben Sie nie Kindern, auf Schubladen, Türen oder Regale zu klettern oder zu knallen.

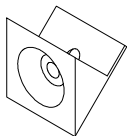
## Parts List(EN) / Teile Liste(DE)

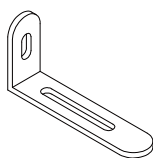
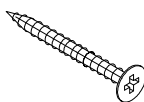
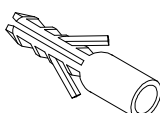
<b>1</b>  1PC	<b>2</b>  1PC	<b>3</b>  1PC	<b>4</b>  1PC
<b>5</b>  1PC	<b>6</b>  2PCS	<b>7</b>  1PC	<b>8</b>  1PC
<b>9</b>  1PC	<b>10</b>  2PCS	<b>11</b>  2PCS	<b>12</b>  2PCS
<b>13</b>  2PCS	<b>14</b>  2PCS	<b>15</b>  2PCS	<b>16</b>  1PC
<b>17</b>  1PC	<b>18</b>  1PC	<b>19</b>  2PCS	<b>20</b>  1PC
<b>21</b>  1PC	<b>22</b>  1PC	<b>23</b>  1PC	

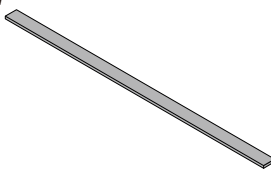

## Parts List(EN) / Teile Liste(DE)

<p><b>A</b></p>  <p>M6×35mm    38+2PCS</p>	<p><b>B</b></p>  <p>Ø15×10mm    38+2PCS</p>	<p><b>C</b></p>  <p>Ø6×30mm    26+2PCS</p>	
<p><b>D</b></p>  <p>M4×40mm    6PCS</p>	<p><b>E</b></p>  <p>M4×30mm    8+1PCS</p>	<p><b>F</b></p>  <p>M3×14mm    12+1PCS</p>	
<p><b>G</b></p>  <p>2PCS</p>	<p><b>H</b></p>  <p>8PCS</p>	<p><b>I</b></p>  <p>M3×12mm    38+2PCS</p>	
<p><b>J</b></p>  <p>4PCS</p>	<p><b>K</b></p>  <p>M4×18mm    4PCS</p>	<p><b>L</b></p>  <p>4PCS</p>	
<p><b>M</b></p>  <p>M4×45mm    2PCS</p>	<p><b>N</b></p>  <p>8+1PCS</p>	<p><b>O</b></p>  <p>M4×12mm    1PC</p>	
<p><b>P</b></p>  <p>1PC</p>	<p><b>Q</b></p>  <p>M4×35mm    1PC</p>	<p><b>R</b></p>  <p>M6×30mm    1PC</p>	<p><b>S</b></p>  <p>2PCS</p>
<p><b>T</b></p>  <p>4PCS</p>	<p><b>U</b></p>  <p>L878mm    1PC</p>	<p><b>V</b></p>  <p>L655mm    1PC</p>	<p><b>W</b></p>  <p>4PCS</p>

## Assembly Steps(EN) / Montageschritte(DE)

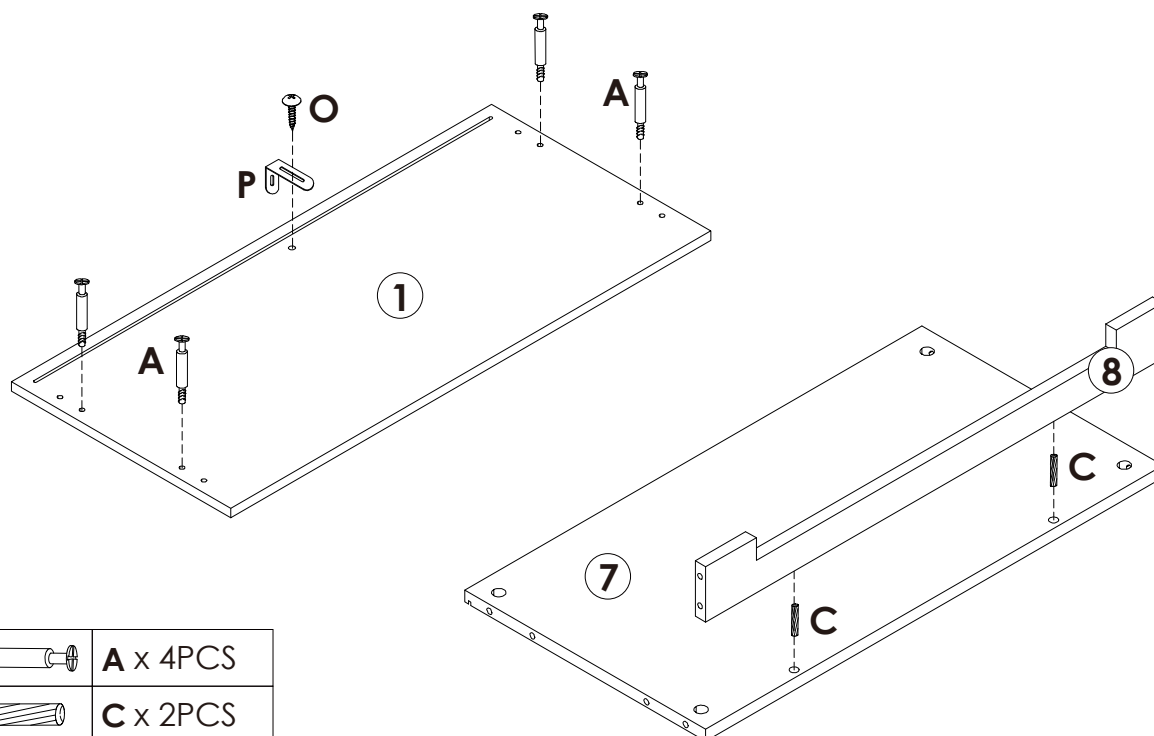
**STEP 1** Please refer to the installation method and position on Step 1 - Lock the long side of the "P" L-shaped metal plate to the ① board with the "O" short screw.

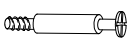
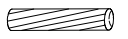

	<b>A</b> x 4PCS
	<b>C</b> x 2PCS
	<b>P</b> x 1PC
	<b>O</b> x 1PC

**STEP 2**

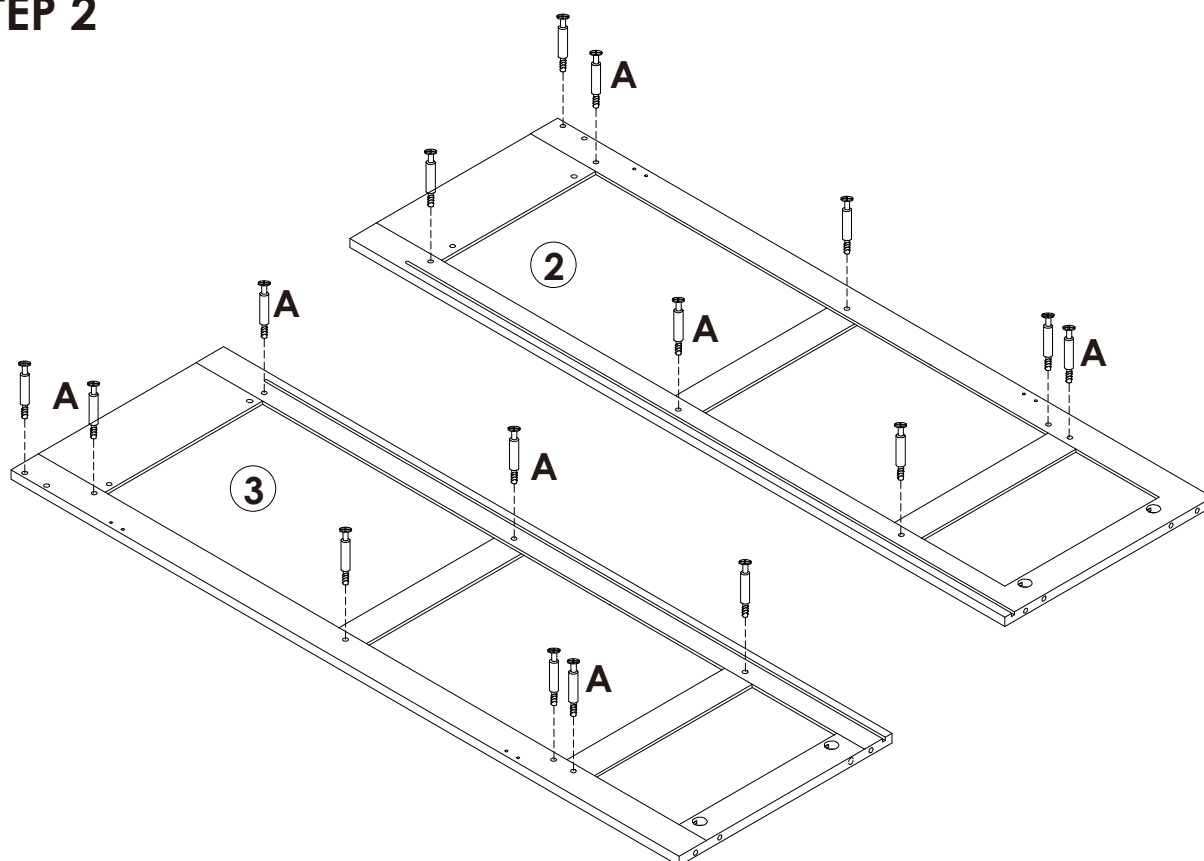



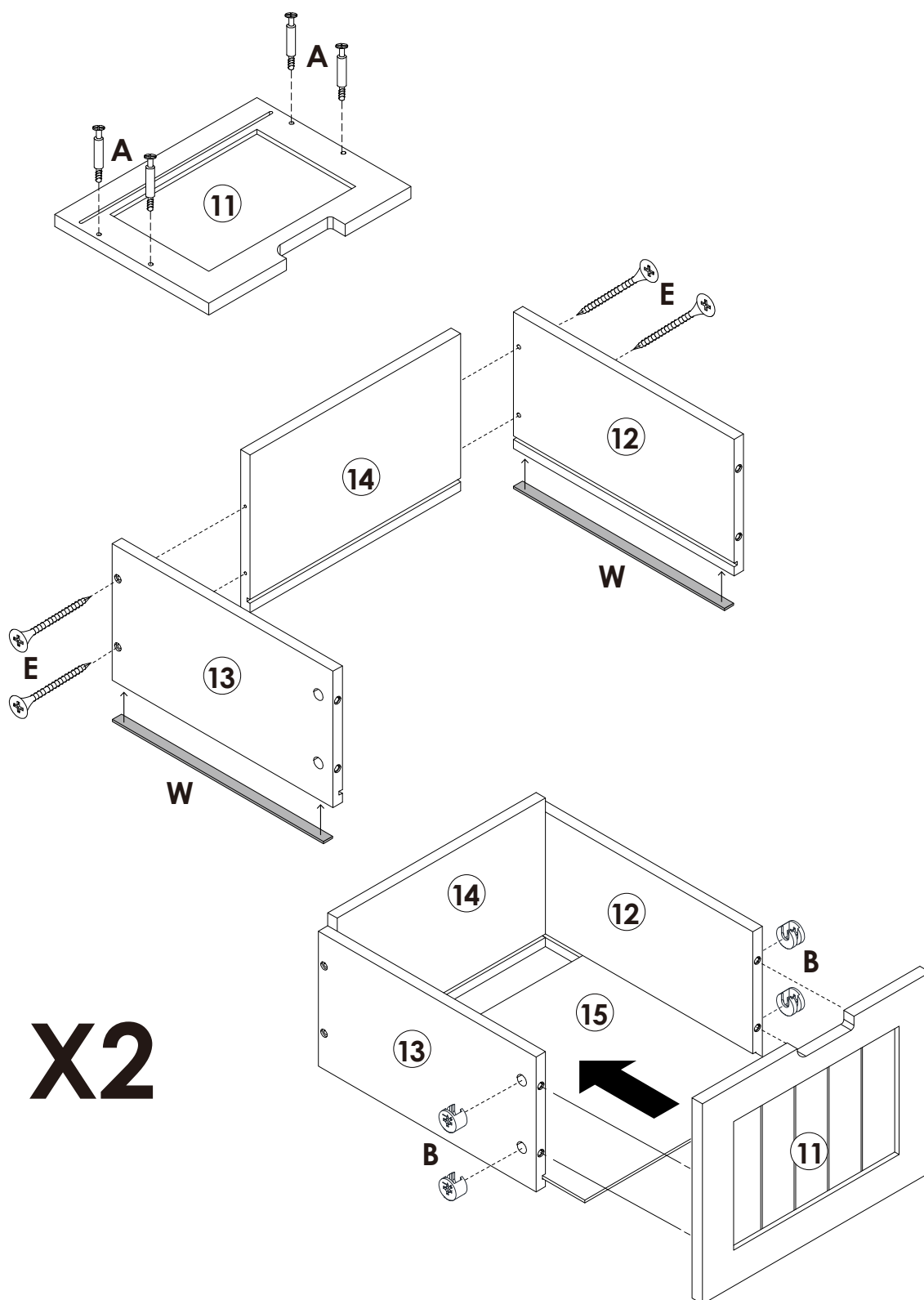

	<b>A</b> x 16PCS
---	------------------

# Assembly Steps(EN) / Montageschritte(DE)

## STEP 3

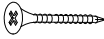

**X2**

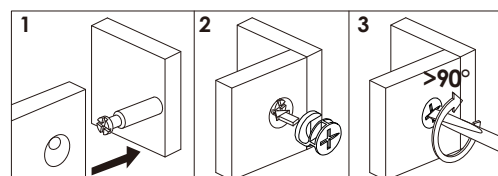

	<b>A x 8PCS</b>
	<b>B x 8PCS</b>
	<b>E x 8PCS</b>
	<b>W x 4PCS</b>

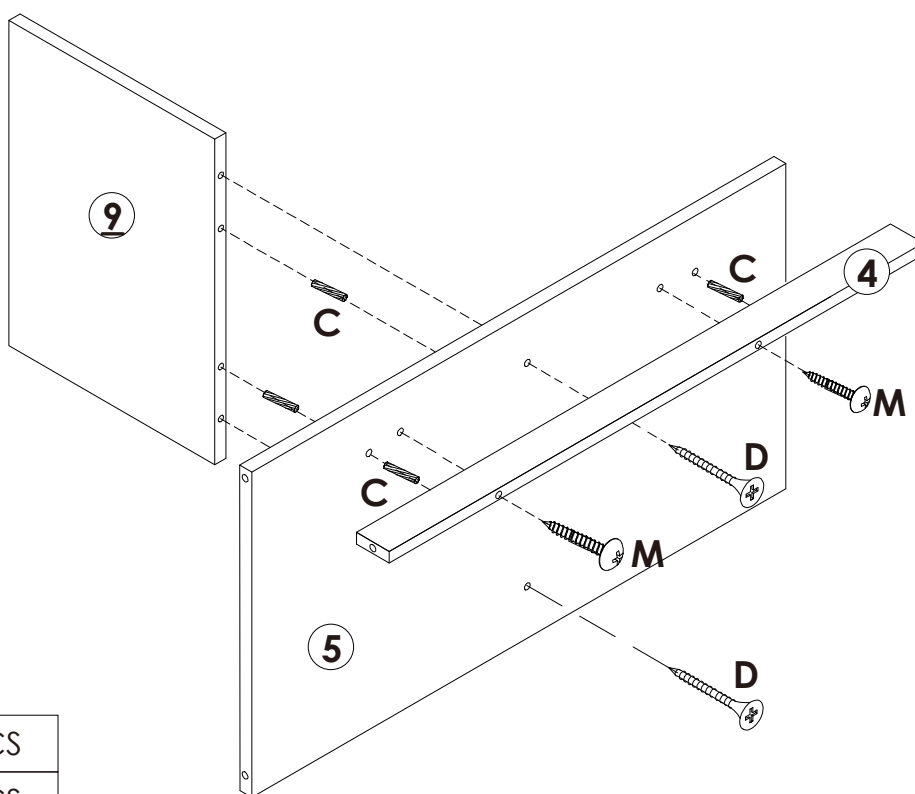

# Assembly Steps(EN) / Montageschritte(DE)

## STEP 4

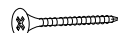

	C x 4PCS
	D x 2PCS
	M x 2PCS

## STEP 5

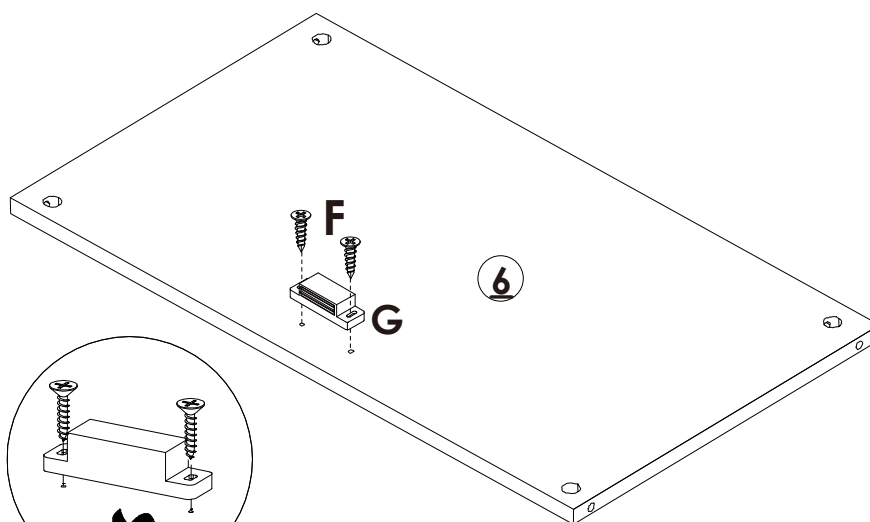



	F x 4PCS
	G x 2PCS

**x2**

# Assembly Steps(EN) / Montageschritte(DE)

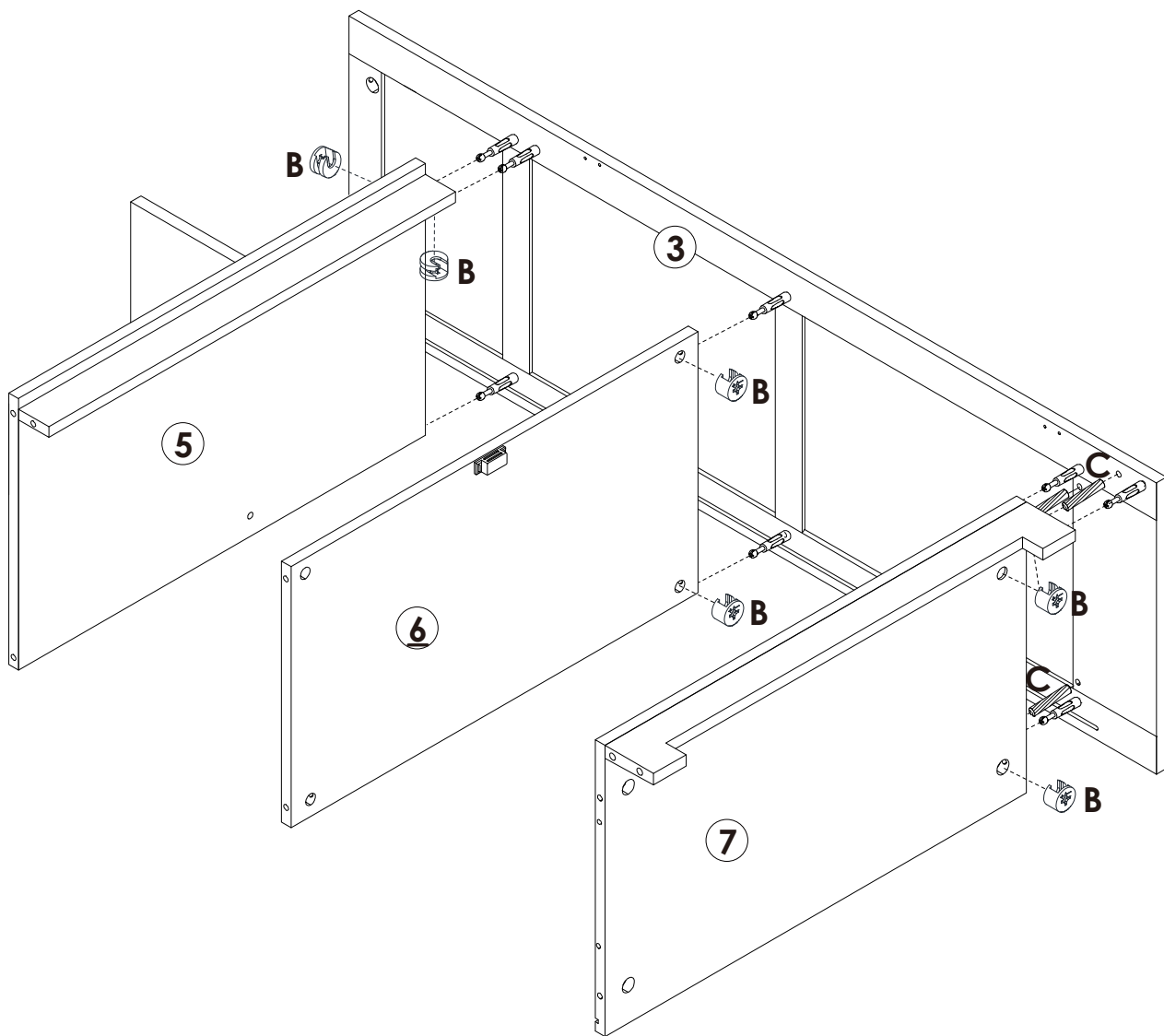
## STEP 6



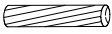

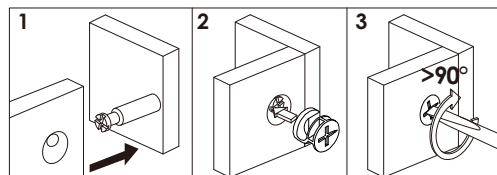
	<b>B</b> x 8PCS
	<b>C</b> x 3PCS

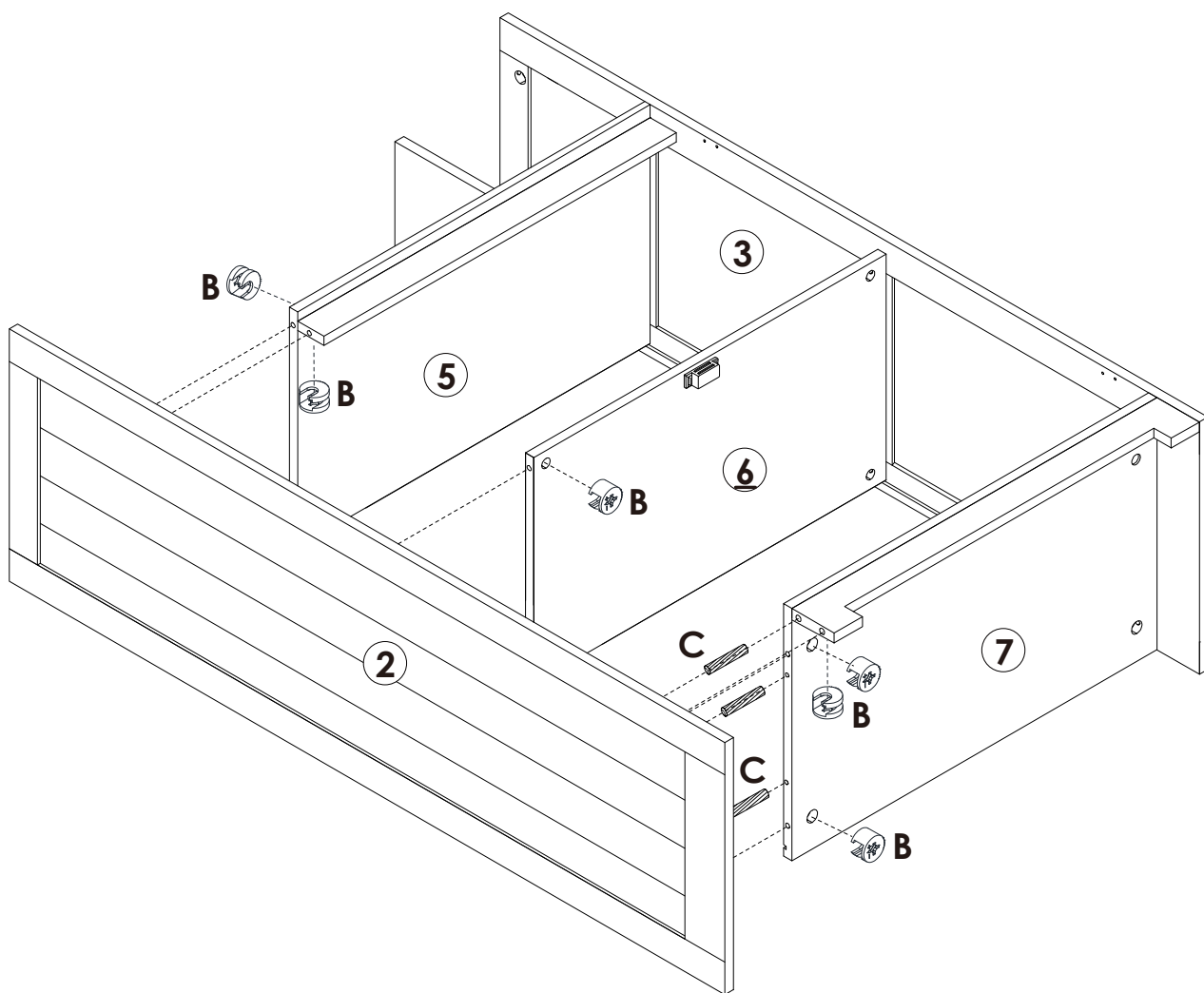

# Assembly Steps(EN) / Montageschritte(DE)

## STEP 7



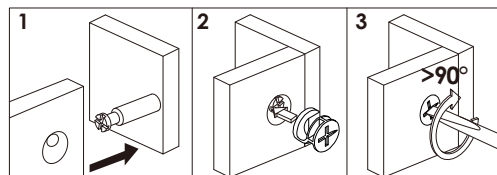

	<b>B</b> x 8PCS
	<b>C</b> x 3PCS

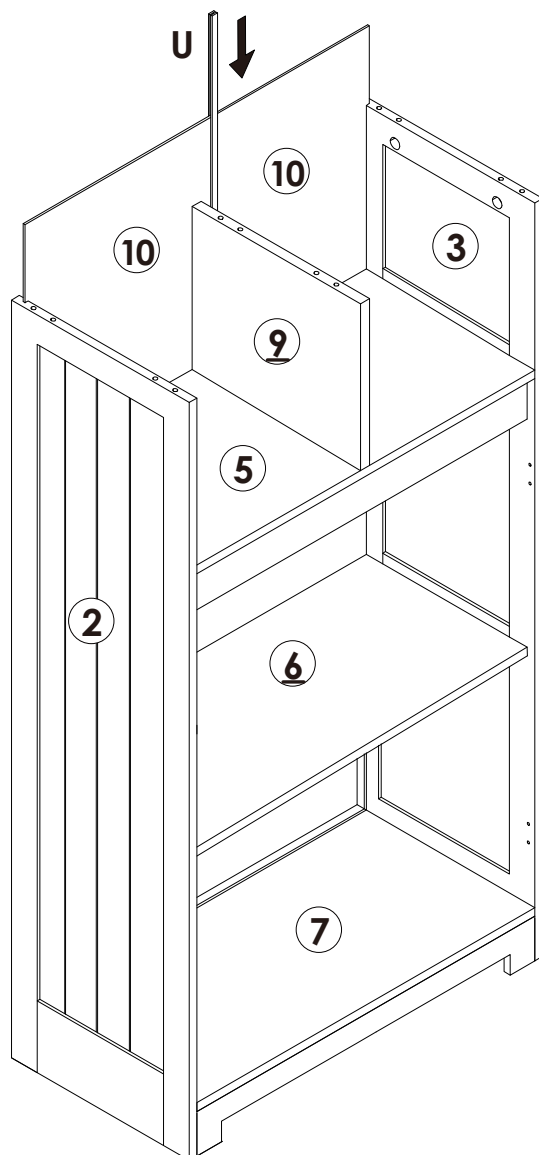

# Assembly Steps(EN) / Montageschritte(DE)

## STEP 8



 U x 1PC

## STEP 9

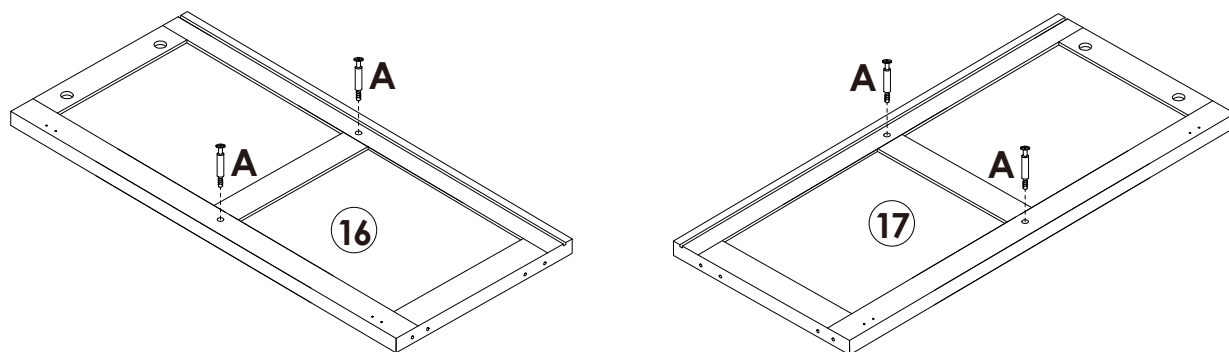

 A x 4PCS

# Assembly Steps(EN) / Montageschritte(DE)

## STEP 10

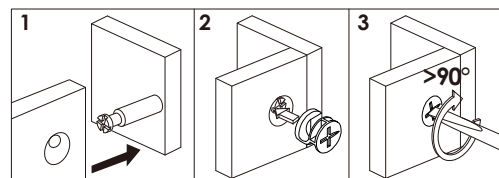
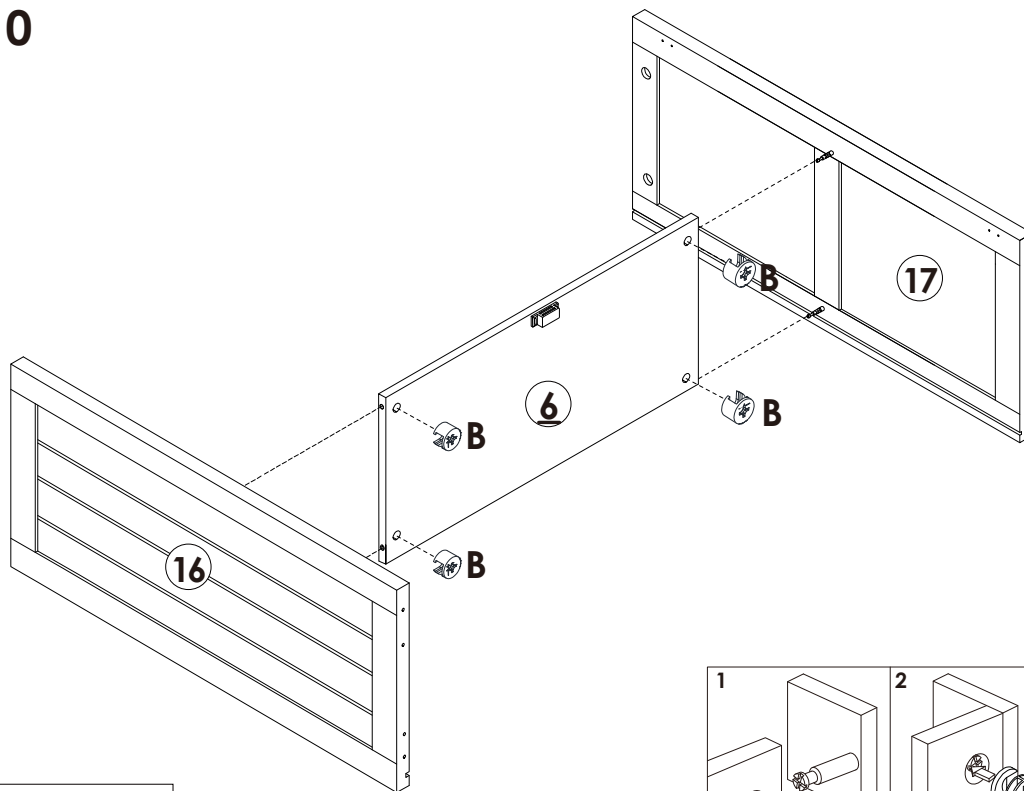

**B x 4PCS**

## STEP 11

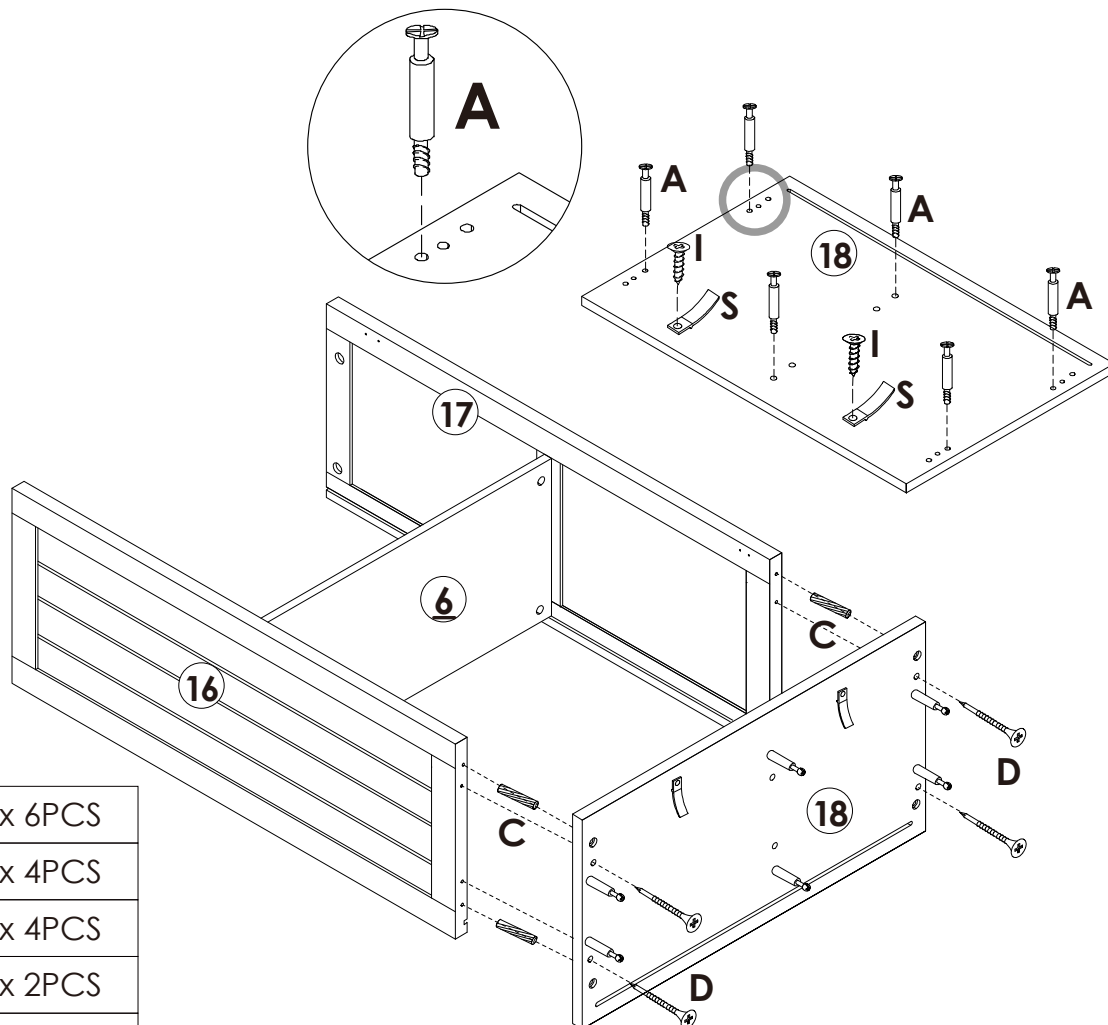



	<b>A x 6PCS</b>
	<b>C x 4PCS</b>
	<b>D x 4PCS</b>
	<b>I x 2PCS</b>
	<b>S x 2PCS</b>

# Assembly Steps(EN) / Montageschritte(DE)

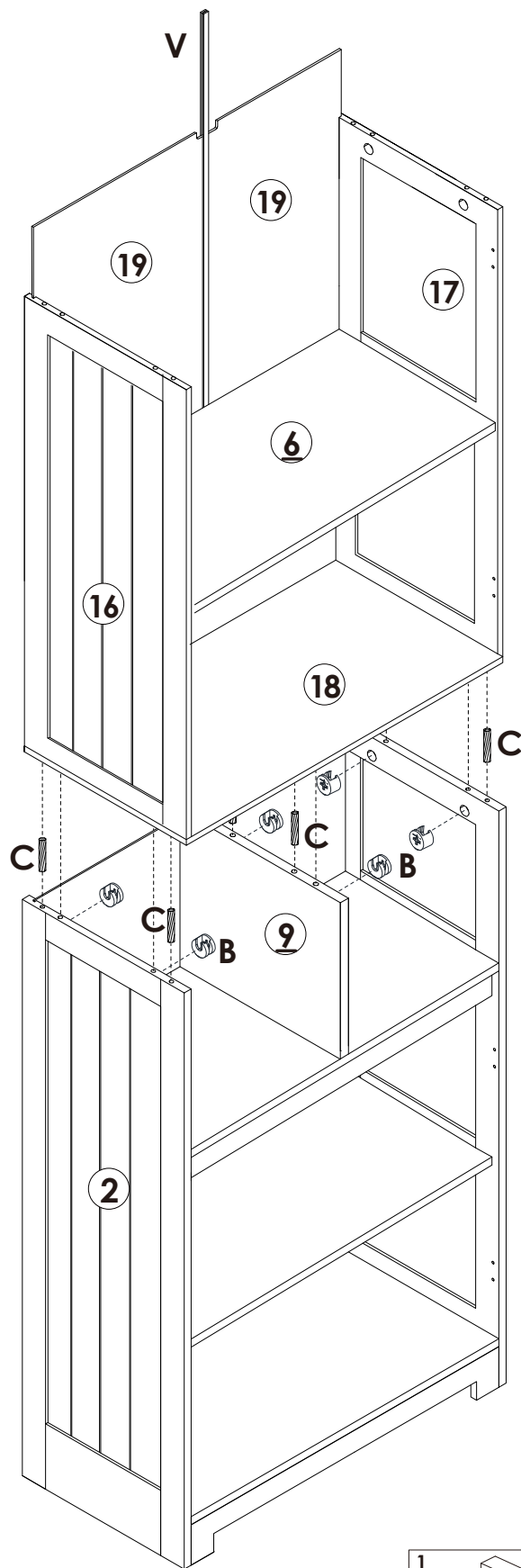
## STEP 12





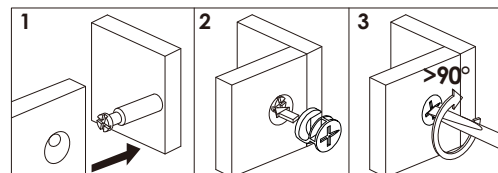

	<b>B</b> x 6PCS
	<b>C</b> x 6PCS
	<b>V</b> x 1PC

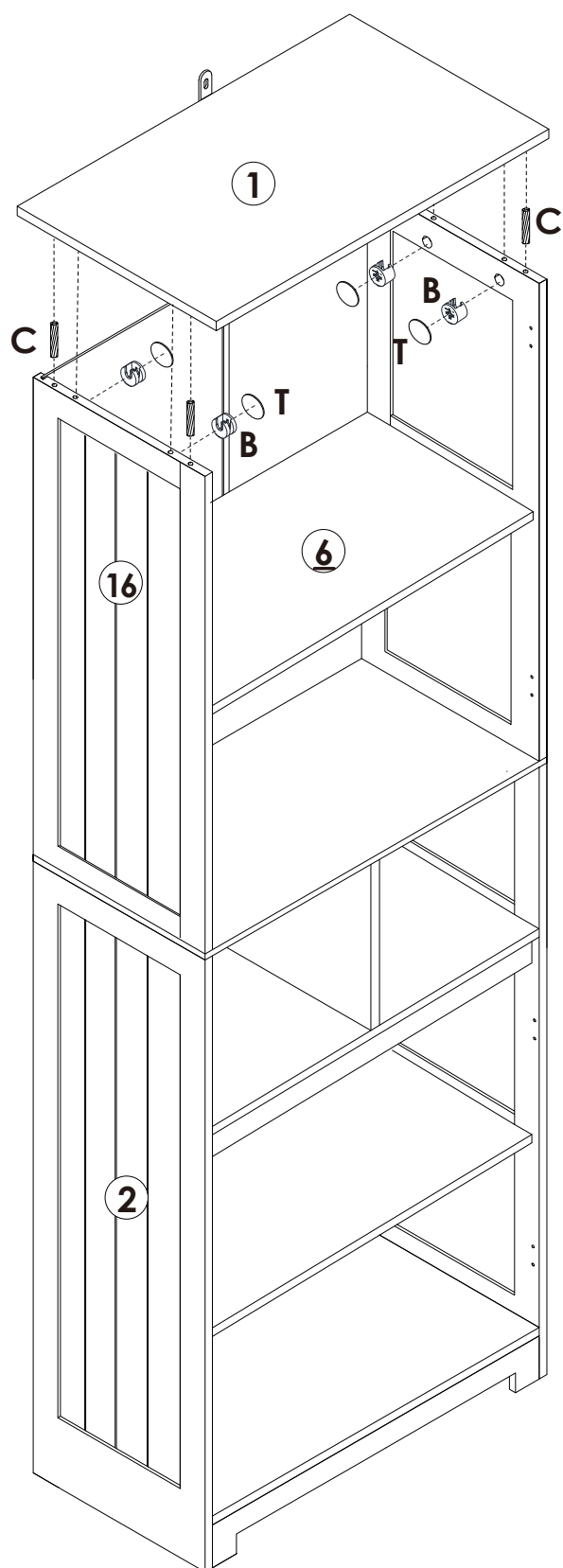

# Assembly Steps(EN) / Montageschritte(DE)

## STEP 13





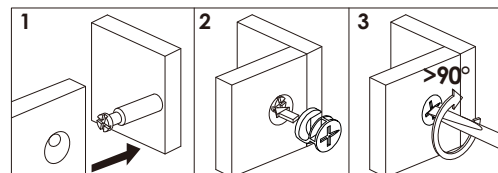



	<b>B</b> x 4PCS
	<b>C</b> x 4PCS
	<b>T</b> x 4PCS

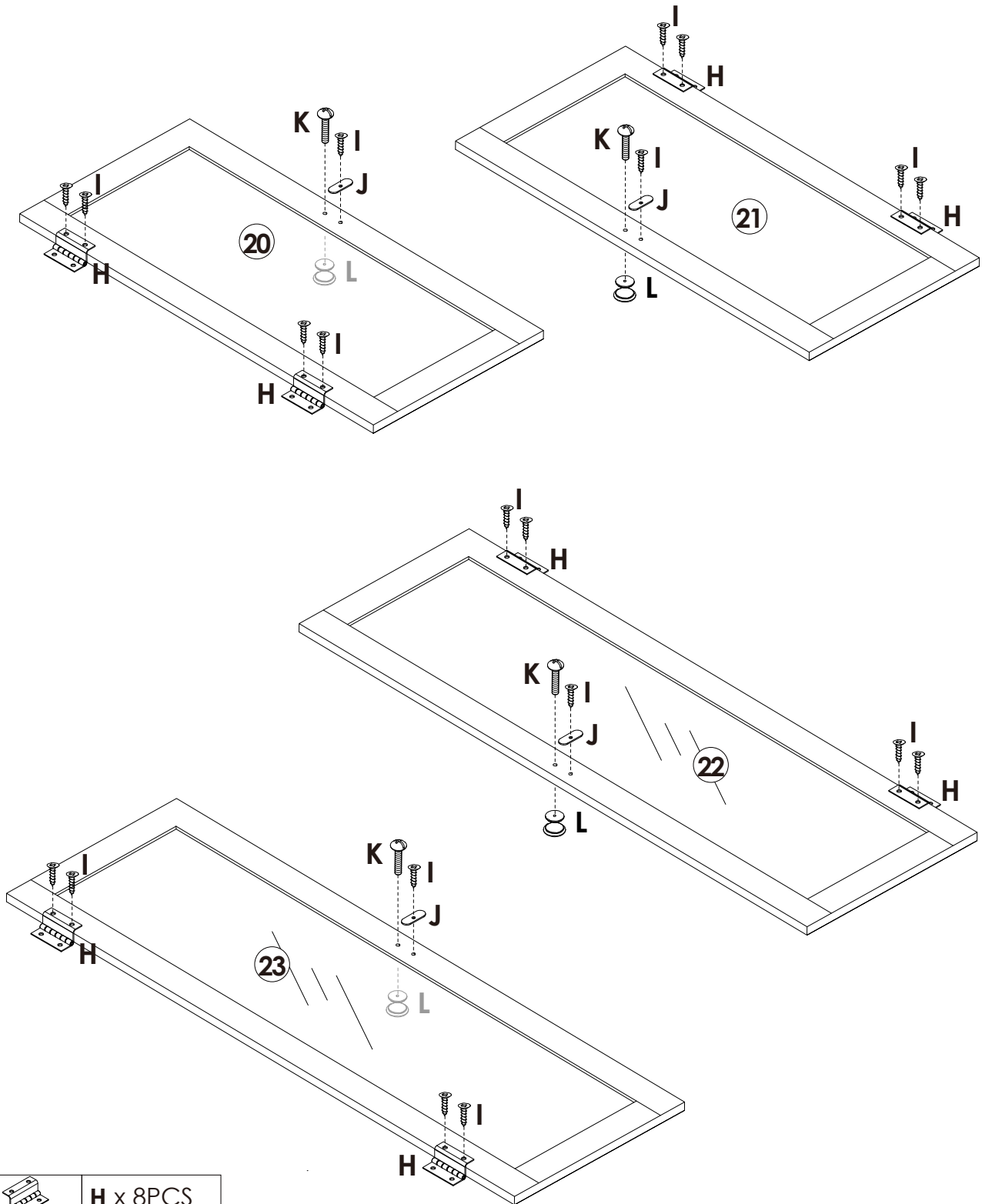

# Assembly Steps(EN) / Montageschritte(DE)

## STEP 14



	H x 8PCS
	I x 20PCS
	J x 4PCS
	K x 4PCS
	L x 4PCS

STEP 15

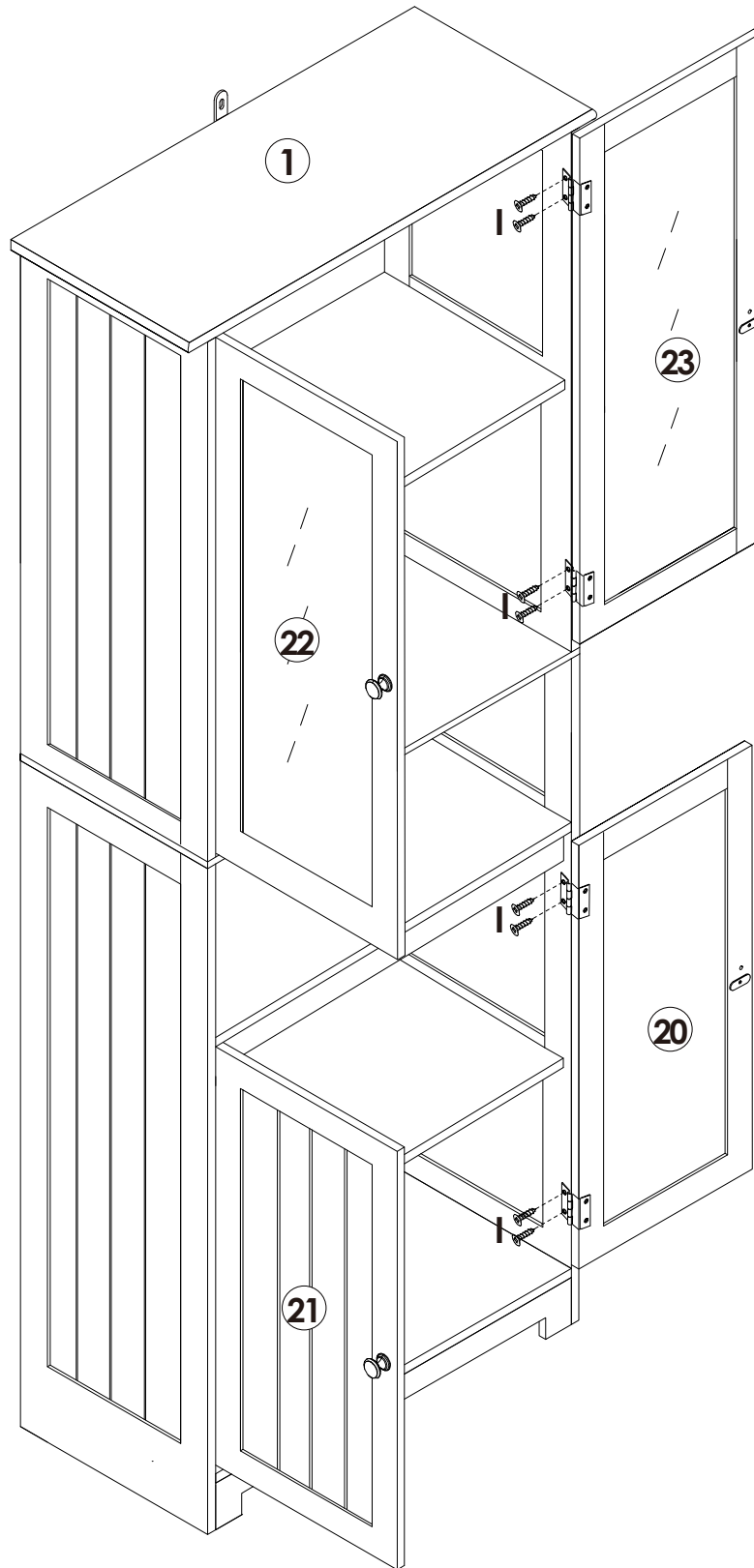

I x 16PCS

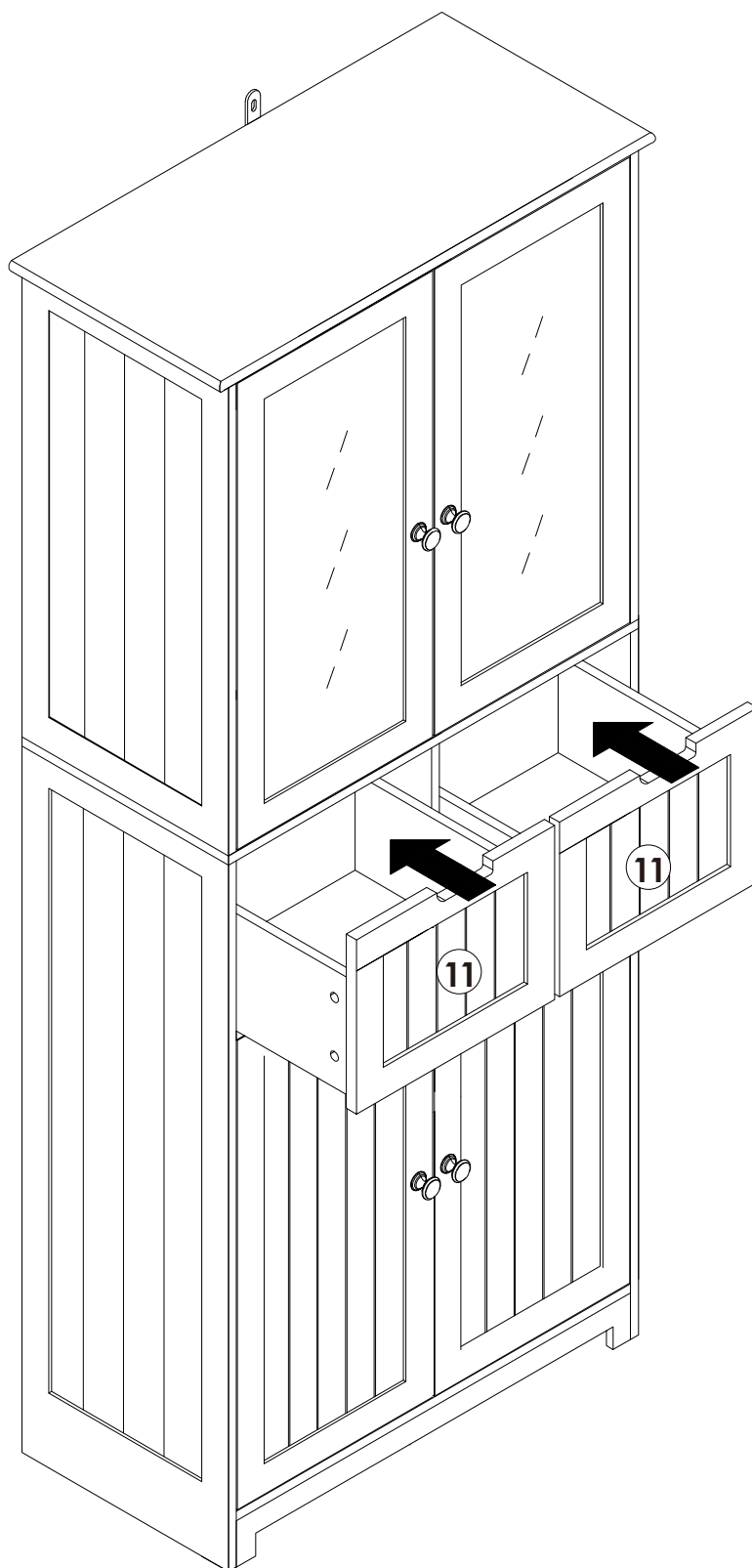

STEP 16

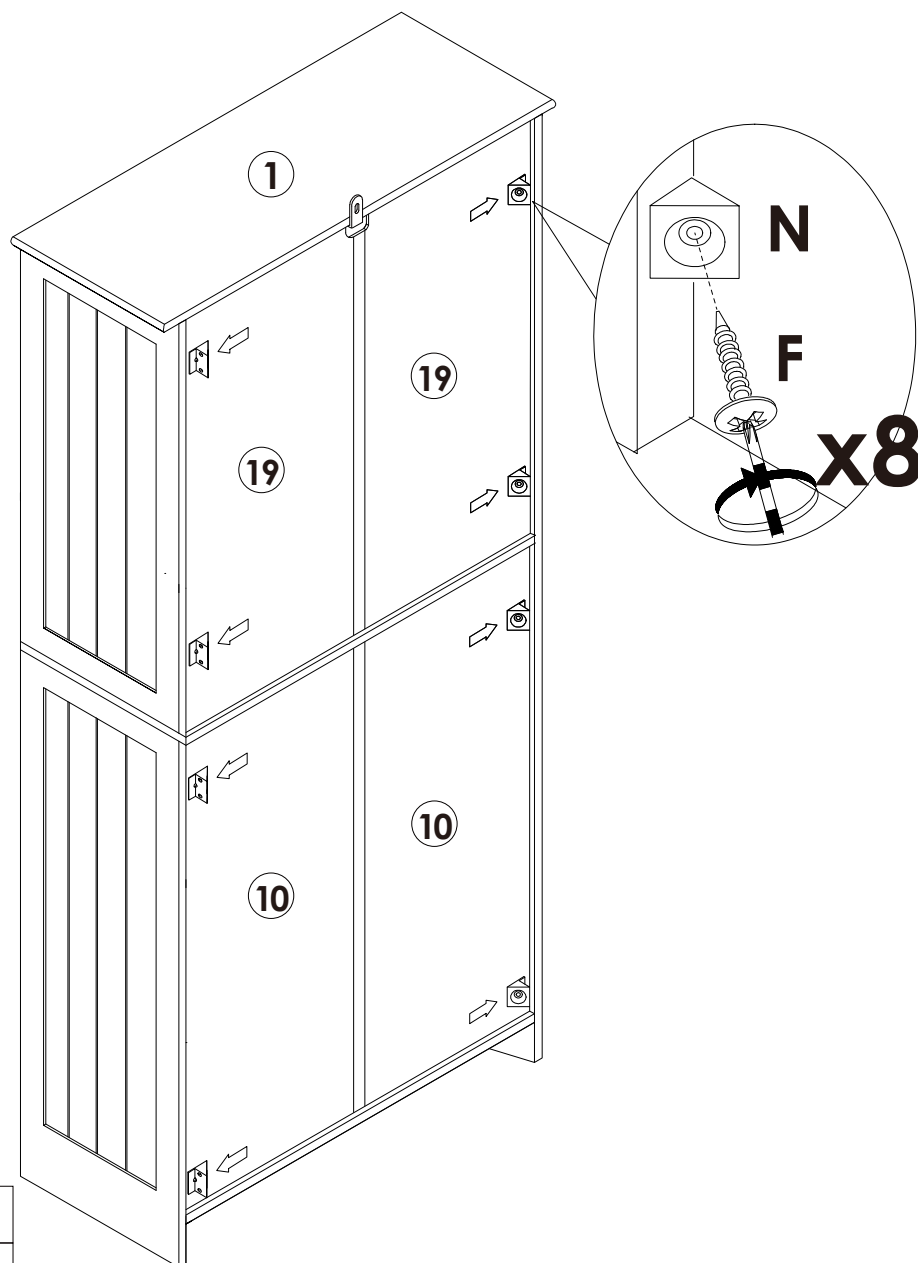

# Assembly Steps(EN) / Montageschritte(DE)

## STEP 17



	F x 8PCS
	N x 8PCS

## STEP 18

Please refer to Step 17 - Drill a hole in the wall at the required height and position for anti-falling device after product installed, and then put the "R" plastic part into the hole.

WALL

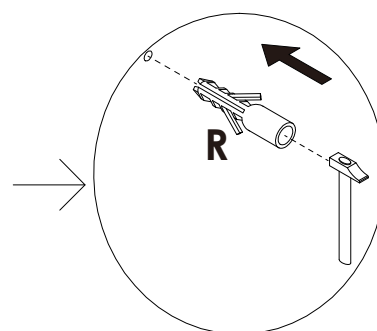
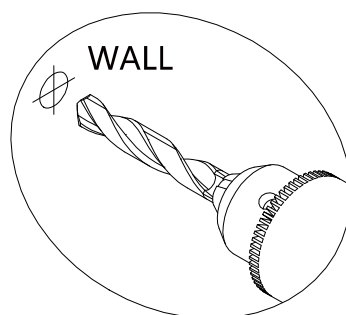
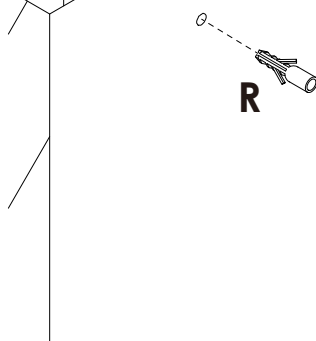

	R x 1PC
---	---------

## Assembly Steps(EN) / Montageschritte(DE)

**STEP 19** Move the cabinet to the appropriate position, and then use the "Q" long screw to lock the plastic part in the wall through the holes of L-shaped metal plate.

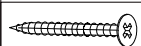
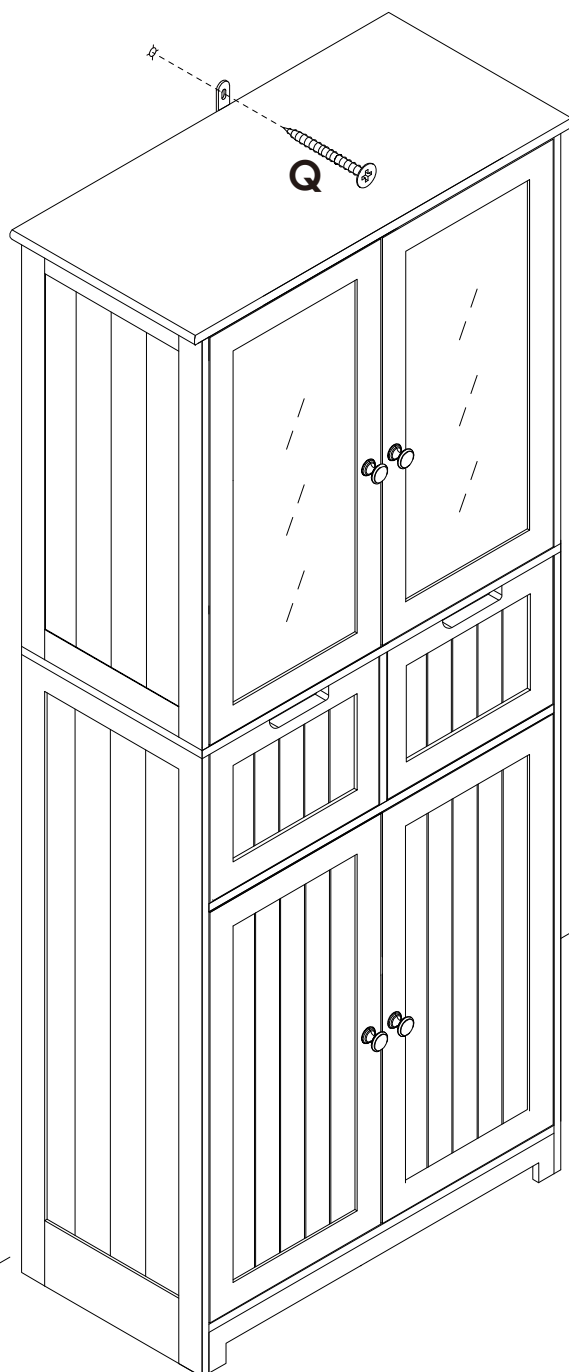

**Q** x 1PC



## WARNING



Children have died from furniture tipover. To reduce the risk of furniture tipover:

- **ALWAYS** install tipover restraint provided.
- **NEVER** put a TV on this product.
- **NEVER** allow children to stand, climb or hang on drawers, doors, or shelves.
- **NEVER** open more than one drawer at a time.
- Place heaviest items in the lowest drawers.

