



ASSEMBLING INSTRUCTIONS





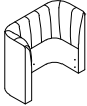

SWIVEL CHAIR

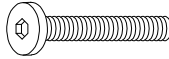

Legs and hardware are stored in the bottom of the seat, please take them out for assembly.

Note: Do not use power tools for assembly. Power tools increase the risk of over tightening which lead to splitting or cracking the wood.

PART	DRAWING	DESCRIPTION	QTY
A		Backrest	1 PC
B		Seat	1 PC
C		Swivel Base	1 PC

PART	DRAWING	DESCRIPTION	QTY
1		Bolt Ø5/16"×1-3/4"	5 PCS
2		Spring Washer Ø5/16"	5 PCS
3		Flat Washer Ø5/16"×3/4"	5 PCS
4		Bolt Ø1/4"×1"	4 PCS
5		Spring Washer Ø1/4"	4 PCS
6		Flat Washer Ø1/4"×3/4"	4 PCS
7		Allen Key M4	1 PC

ASSEMBLING INSTRUCTIONS

SWIVEL CHAIR

STEP 1:

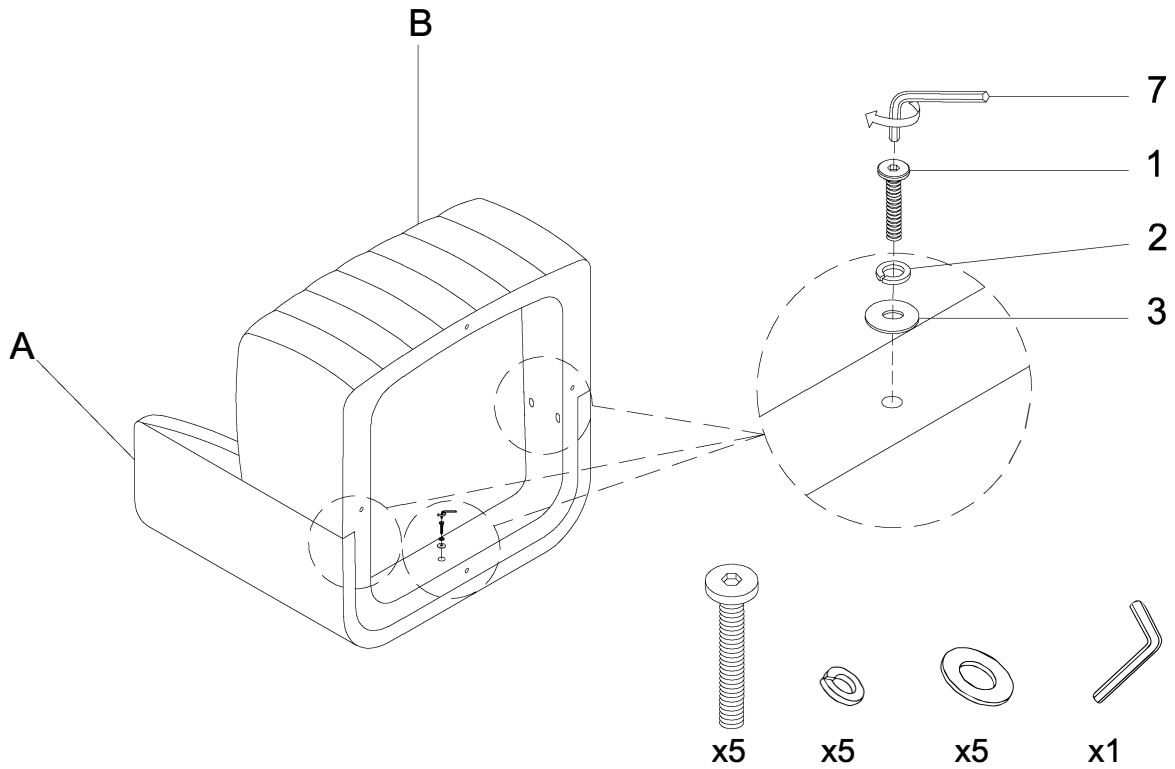

STEP 2:

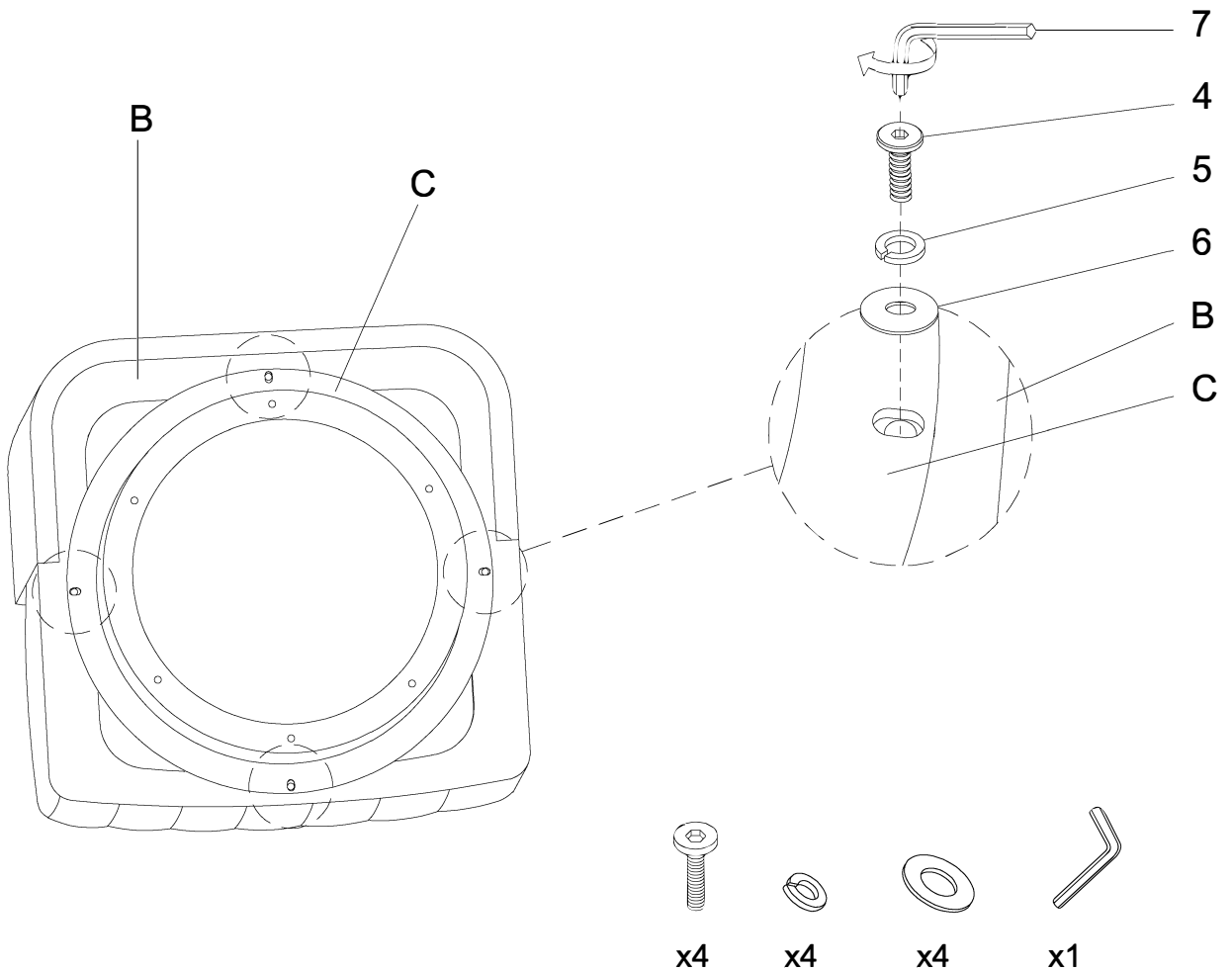

ASSEMBLING INSTRUCTIONS

SWIVEL CHAIR

COMPLETED

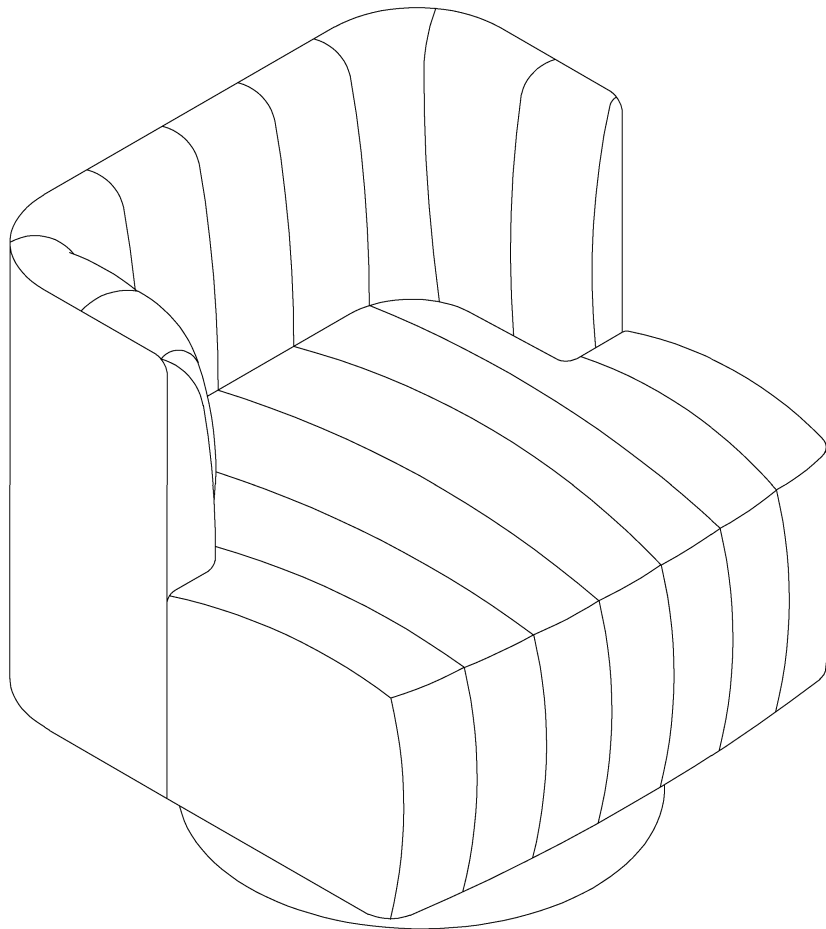

Care Instruction for Textured Fabric Furniture:

In order to maintain the original appearance of your Textured Fabric furniture, please follow below simple care procedures:

- Avoid exposing furniture directly to sunlight or heating and air conditioning outlets.
Sunlight and or exposure to heating and air conditioning outlets will fade / damage Textured Fabric .
- Vacuum or wipe with a soft cloth to remove dust.
- Hardware may loosen over time. Periodically check to make sure all connection are tight, Re-tighten if necessary

 For item use on wooden floor,hard surfaces or carpets,it is recommended to install protective pads under all legs and supports to avoid/prevent from damages/scratches and discoloration.